

2022 NEW EDITION

RAS
SURGICAL

Manufacturer & Exporter Of

SURGICAL INSTRUMENTS

www.rassurgical.com

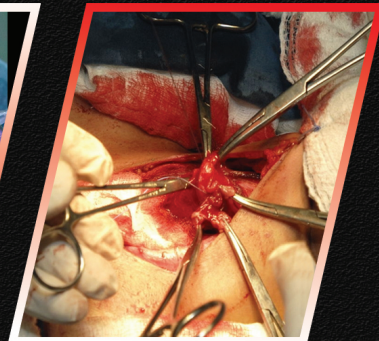

Percussion Hammers & Aesthesiometers



01-101
TROEMNER
Size: 245 mm

1/2



01-102
DEJERINE
Size: 200 mm

1/2



01-103
DEJERINE
With Needle
Size: 210 mm

1/2

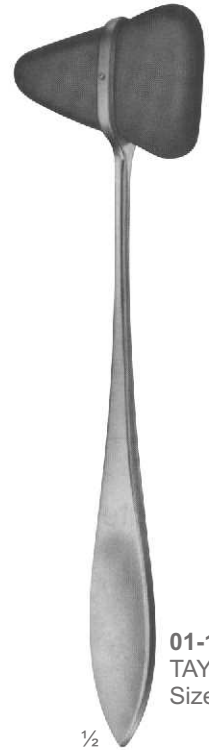

01-104
TAYLOR
Size: 195 mm

1/2



01-105
BERLINER
Size: 200 mm

1/2

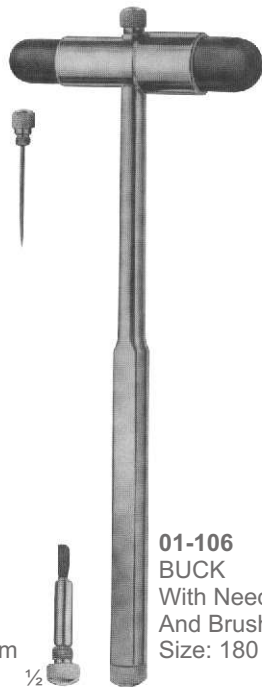

01-106
BUCK
With Needle
And Brush
Size: 180 mm

1/2

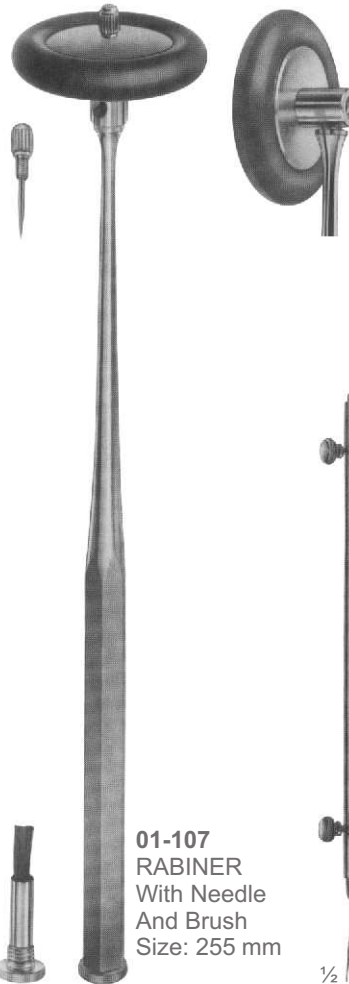

01-107
RABINER
With Needle
And Brush
Size: 255 mm

1/2



01-108
ALY
Size: 190 mm

1/2



01-109
WARTENBERG
Pinwheel For
Neurological
Examination
Size: 185 mm

1/2

Stethoscopes



01-110
PINARD (Aluminum)
Size: 155 mm

1/2



01-111
aus Holz (Wooden)
Size: 145 mm

1/2



01-112
BOWLES
Stethoscope
With Diaphragm

1/4

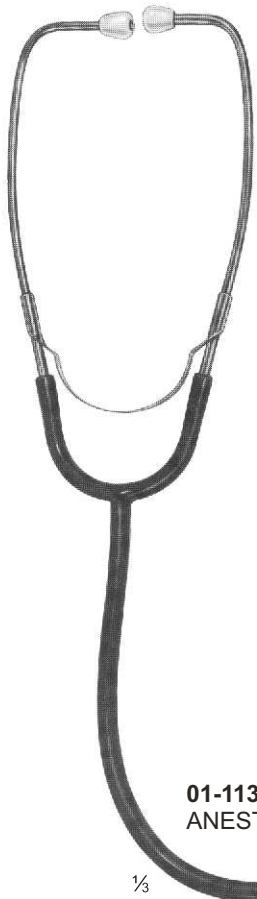

01-113
ANESTOPHON

1/3

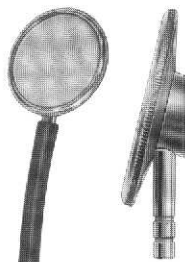

01-114
FORD-BOWLES
Duel Chest Piece
With Two Outlets

1/4



01-115
BOWLES

1/4

Head Mirrors & Head Bands

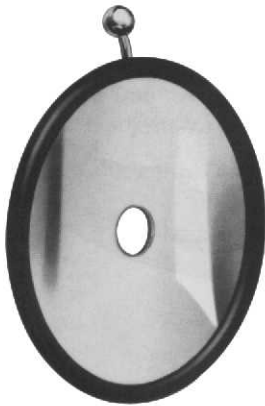

01-116
ZIEGLER \varnothing mm
Head mirror only
with rubber coating

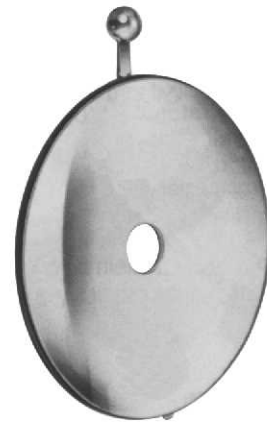

01-117
ZIEGLER \varnothing mm
Head mirror only
with metal coating



01-118
ZIEGLER
Head band of plastic black

01-119
ZIEGLER
Head band of plastic white

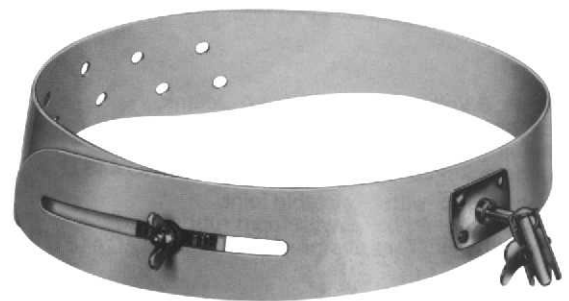

01-120
MURPHY
Head band of celluloid, white

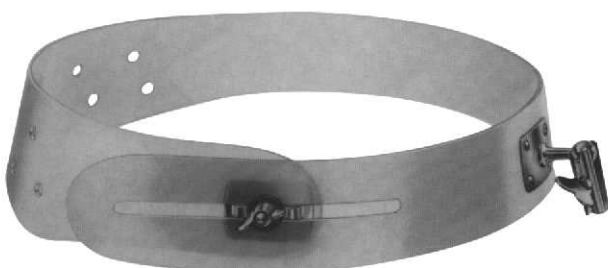

01-121
Head band of plastic,
white, soft pattern



01-122
Head mirror with black
plastic head band.

Head Light

01-123

CLAR

Head light, 6 volt, with adjustable joint,
white celluloid head band,
cord with plugs for transformer

01-124

White celluloid head band, only, for

01-125

Spare mirror only, for



01-126
spare bulb

01-127

CLAR

Head light, 6 volt, with adjustable joint,
white celluloid head band, with foam rubber pad
and cord with plugs for transformer

01-128

White celluloid head band, only, for head light

01-129

mirror only, for head light

spare foam rubber pad, for head band

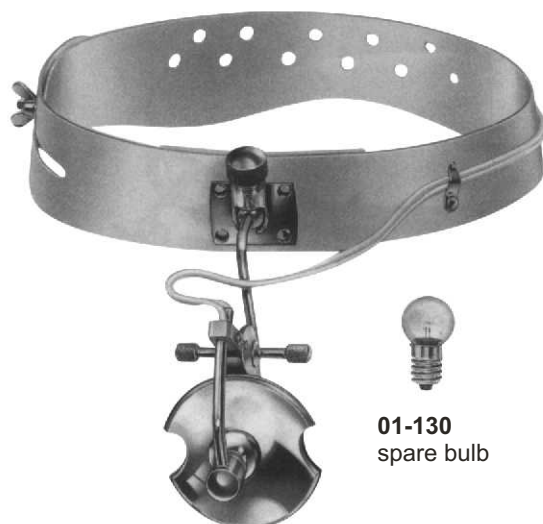

01-130
spare bulb

01-131

CLAR

Head light, 6 volt, with adjustable joint,
white plastic head band,
cord with plugs for transformer



01-132
spare bulb

Tongue Depressors



01-133
Size: 150 mm



01-134
Size: 145 mm



01-135
Size: 140 mm

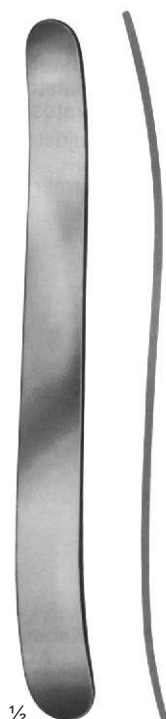

01-136
BUCHWALD
Size: 180 mm



01-137
BRUENINGS
Size: 190 mm

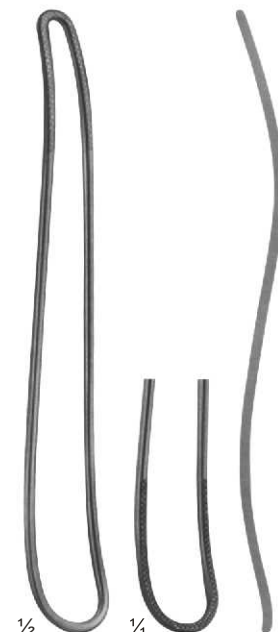

01-138
FRENZEL
Size: 165 mm

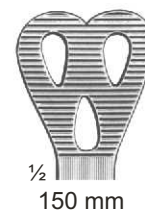

$\frac{1}{2}$
150 mm



$\frac{1}{2}$
140 mm

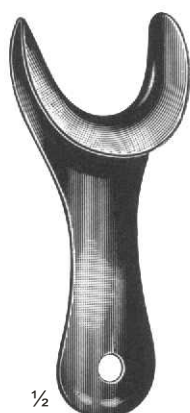

01-139
SIMPLEX
Size: 110 mm



01-140
STEMBERG
Size: 120 mm, 140 mm, 160 mm

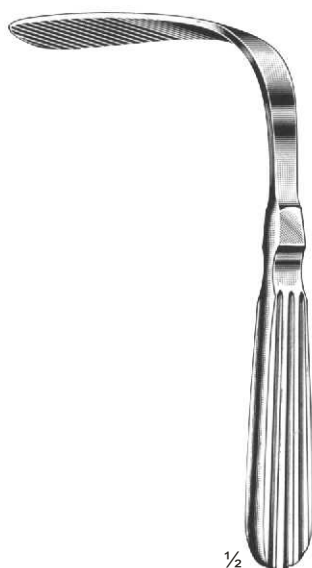

01-141
TOBOLD
Size: 145 mm



01-142
ANDREW
Size: 110 mm



01-143
WIEDER

Tongue Depressors



1/2

01-144
SCHIMMELBUSCH
Ether Mask



1/2

01-145
HEISTER
Mouth Gag
Size: 130 mm



1/2

01-146
FERGUSSON-ACKLAND
Mouth Gag
Size: 145 mm



1/2

01-147
DENHARDT
Mouth Gag With Silicon
Inserts, Interchangeable
Size: 125 mm



1/2

01-148
ROSIER KONIG
Mouth Gag
Size: 160 mm, 185 mm



1/2

01-149
YOUNG
Size: 165 mm



1/4

1 Pair Of
Rubber Pads

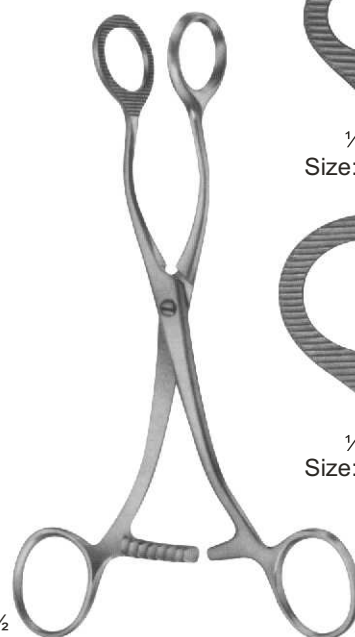

1/2

01-150
COLLIN
Size: 160 mm, 170 mm



1/4

Size: 160 mm



1/4

Size: 170 mm

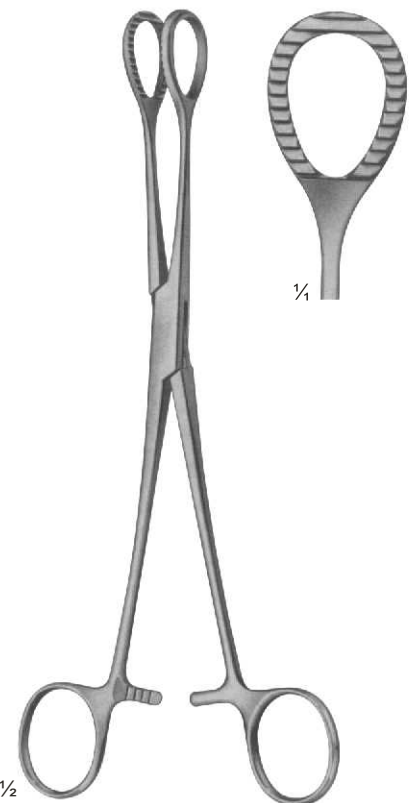

1/2

01-151
HEYWOOD-SMITH modif.
Size: 215 mm

Blood Lancets & Laryngeal Mirrors



01-152
FRANCKE
Automatic Blood Lancet



01-153
KOLLE
Microscopic Needle Holder
With Plastic Handle
Size: 240 mm

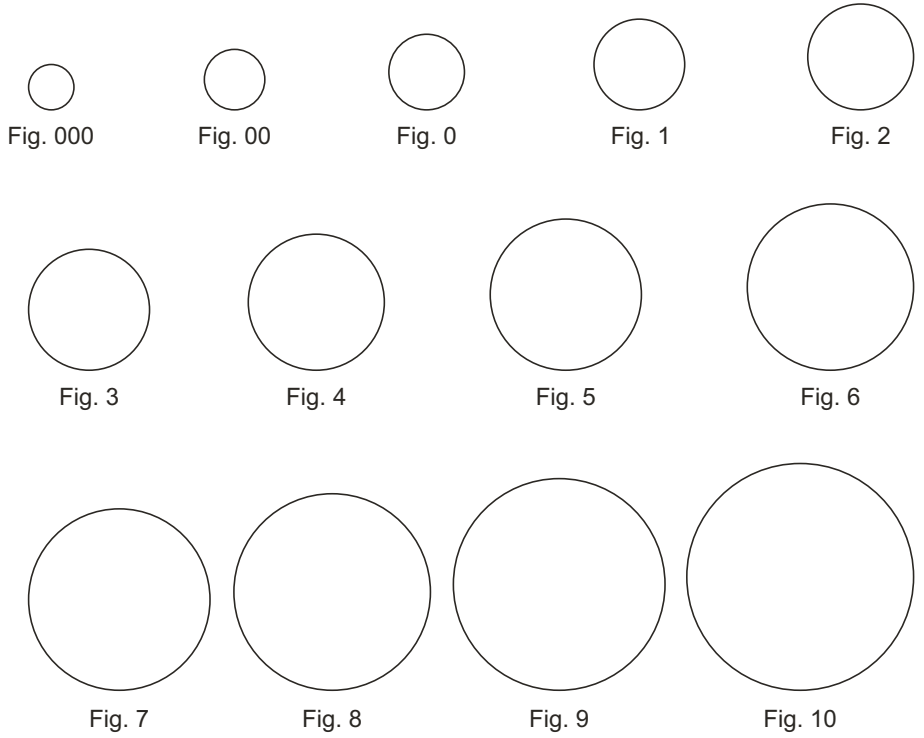

01-154
Laryngeal Mirrors With
Hexagonal Handle
Size: 180 mm



01-155
Mirror Handle
Size: 110 mm



01-156
Mirror Handle
Size: 105 mm



01-157
MICHEL
Rhinoscopic Mirrors With
Interchangeable Mirror Inserts
Size: 250 mm



01-158
Spare Mirrors Only
Size: 12 mm



01-159
Spare Mirrors Only
Size: 14 mm

Diagnostic Sets



01-160 - 162
MAGILL



01-160
Infants
Size: 150 mm



01-161
Children
Size: 200 mm



01-162
Adults
Size: 250 mm



01-163
Medium battery handle
only, 25 mm diam.



01-163-A
Spare bulb
2.7 volt, for
otoscopes



01-163-B
Spare bulb
2.6 volt, for
ophthalmoscopes



01-164
Otoscope Set, Consists Of
Battery Handle Without Batteries,
3 Ear Specula, 1 Bulb In Velvet Lined Case



01-165
Diagnostic Set, Otoscope With Three Specula,
Nasal Speculam, Lamp Holder, Two Laryngeal
Mirrors, Tongue Blade Holder

Diagnostic Sets



1/3

01-166
MILLER
 Laryngoscope Set, Consists Of Battery Handle (Without Battery)
 With Four Miller Laryngoscope Blades



Fig. 0

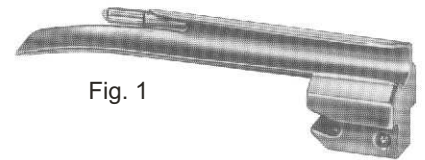

Fig. 1

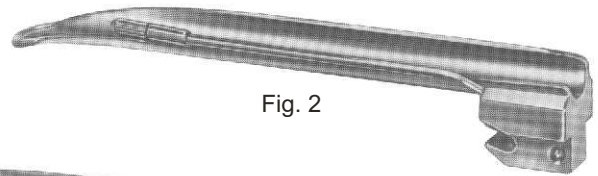

Fig. 2

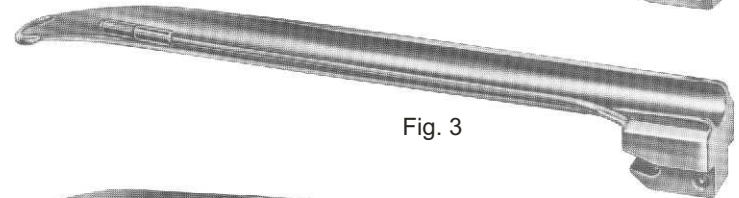

Fig. 3

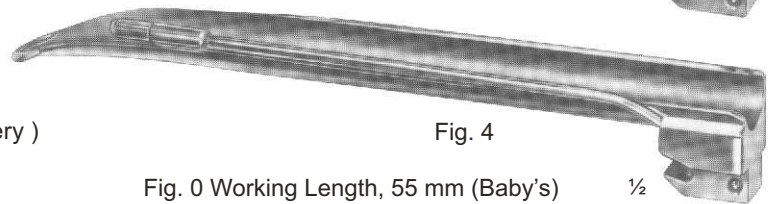

Fig. 4

Fig. 0 Working Length, 55 mm (Baby's) 1/2
 Fig. 1 Working Length, 80 mm (Children's)
 Fig. 2 Working Length, 130 mm (Adolescent's)
 Fig. 3 Working Length, 170 mm (Women's)
 Fig. 4 Working Length, 180 mm (Men's)



1/3

01-167
GUEDEL-NEGUS
 Laryngoscope Set, Consists Of Battery Handle (Without Battery)
 With Four Miller Laryngoscope Blades



Fig. 1



Fig. 2



Fig. 3



Fig. 4

Fig. 1 Working Length, 70 mm (Children's) 1/2
 Fig. 2 Working Length, 90 mm (Adolescent's)
 Fig. 3 Working Length, 110 mm (Women's)
 Fig. 4 Working Length, 135 mm (Men's)

Diagnostic Sets



1/3

01-168
 McIntosh
 Laryngoscope Set, Consists Of Battery Handle (Without Battery)
 With Three McIntosh Blades, Fig. 1, Fig. 2, Fig. 3

01-169
 McIntosh
 Laryngoscope Set, Consists Of Battery Handle (Without Battery)
 With Five McIntosh Blades, Fig. 1, Fig. 2, Fig. 3, Fig. 4, Fig. 5

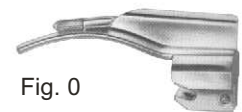

Fig. 0



Fig. 1



Fig. 2

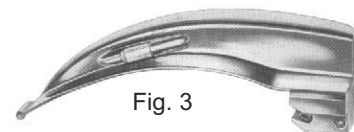

Fig. 3

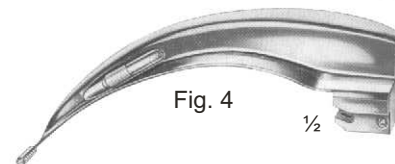
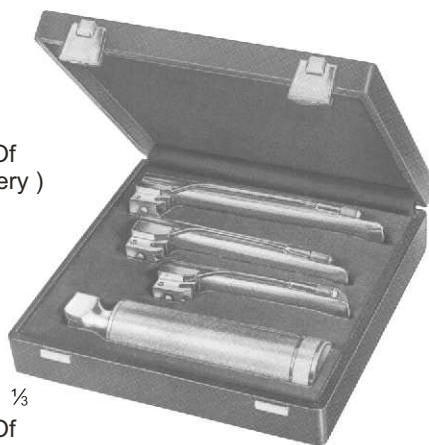

Fig. 4

1/2

Fig. 0 Working Length, 55 mm (Baby's)
 Fig. 1 Working Length, 75 mm (Children's)
 Fig. 2 Working Length, 90 mm (Adolescent's)
 Fig. 3 Working Length, 110 mm (Women's)
 Fig. 4 Working Length, 135 mm (Men's)

01-170
 FOREGGER
 Laryngoscope Set, Consists Of
 Battery Handle (Without Battery)
 With Three Foregger Blades,
 Fig. 1, Fig. 2, Fig. 3,



1/3

01-171
 FOREGGER
 Laryngoscope Set, Consists Of
 Battery Handle (Without Battery)
 With Five Foregger Blades,
 Fig. 1, Fig. 2, Fig. 3, Fig. 4, Fig. 5



Fig. 1



Fig. 2



Fig. 3

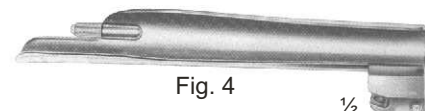

Fig. 4

1/2

Fig. 1 Working Length, 70 mm (Children's)
 Fig. 2 Working Length, 90 mm (Adolescent's)
 Fig. 3 Working Length, 110 mm (Women's)
 Fig. 4 Working Length, 135 mm (Men's)



1/2

01-172
 Fiber Optic
 Battery Handle

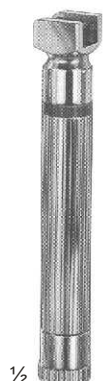

1/2

01-173
 Fiber Optic
 Battery Handle



1/4

01-174
 Replacement Lamp
 (Krypton) 2.5 V



1/4

01-175
 Replacement Lamp
 (Halogen) 2.5 V

Examination & Measuring Instruments

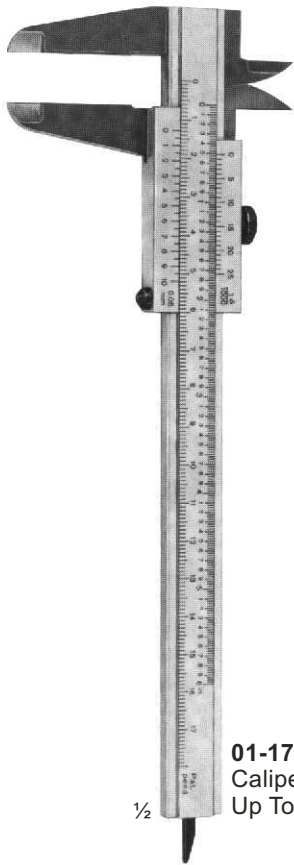

01-176
Caliper Of Aluminum
Up To 180 mm

1/2

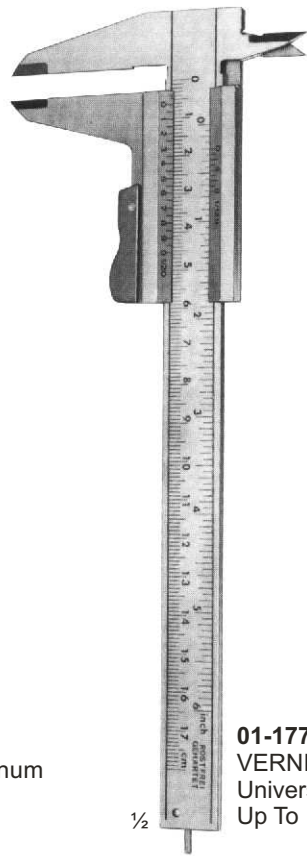

01-177
VERNIER
Universal Caliper Of Steel
Up To 120 mm

1/2

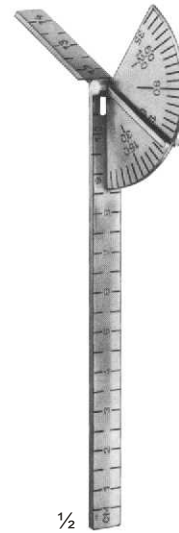

01-178
CAROLL
Size: 140 mm

1/2



01-179
TOWNLEY
Size: 100 mm

1/2

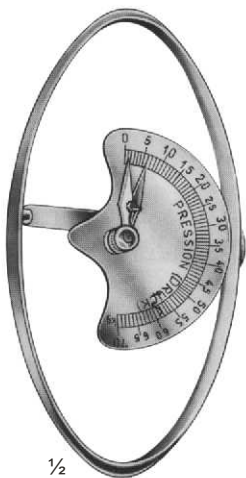

01-180
COLLIN
Druck Pressure 72 kg
Size: 125 mm

1/2

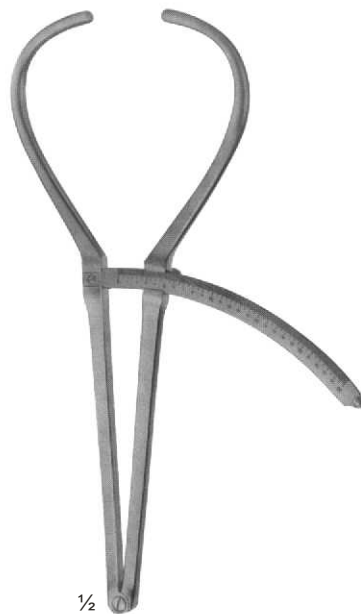

01-181
BERTILLON
Caliper For Measuring The Head
Size: 320 mm

1/2

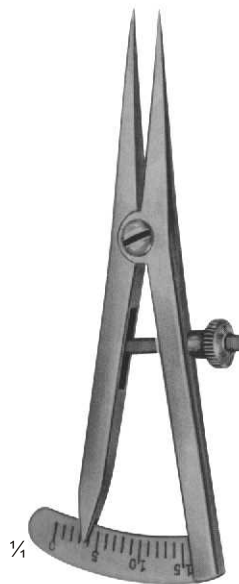

01-182
CASTROVIEJO
Caliper

1/4

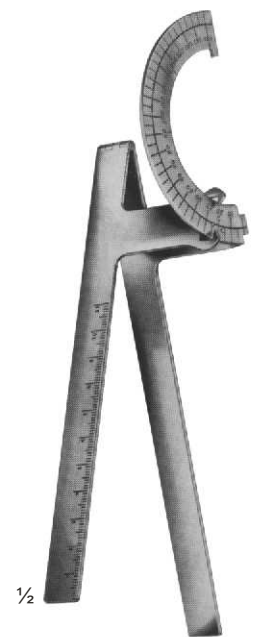

01-183
MOLTGEN
Goniometer

1/2

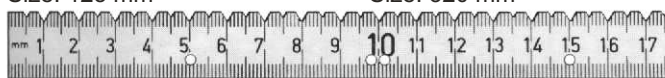

01-185
Size: 150 mm



01-184
Size: 500 mm



Dissecting Knives



02-101 - 110
Fig. 1 - 10



02-101
Fig. 1



02-102
Fig. 2



02-103
Fig. 3



02-104
Fig. 4



02-105
Fig. 5



02-106
Fig. 6



02-107
Fig. 7



02-108
Fig. 8



02-109
Fig. 9



02-110
Fig. 10

Autopsy & Cartilage Knives

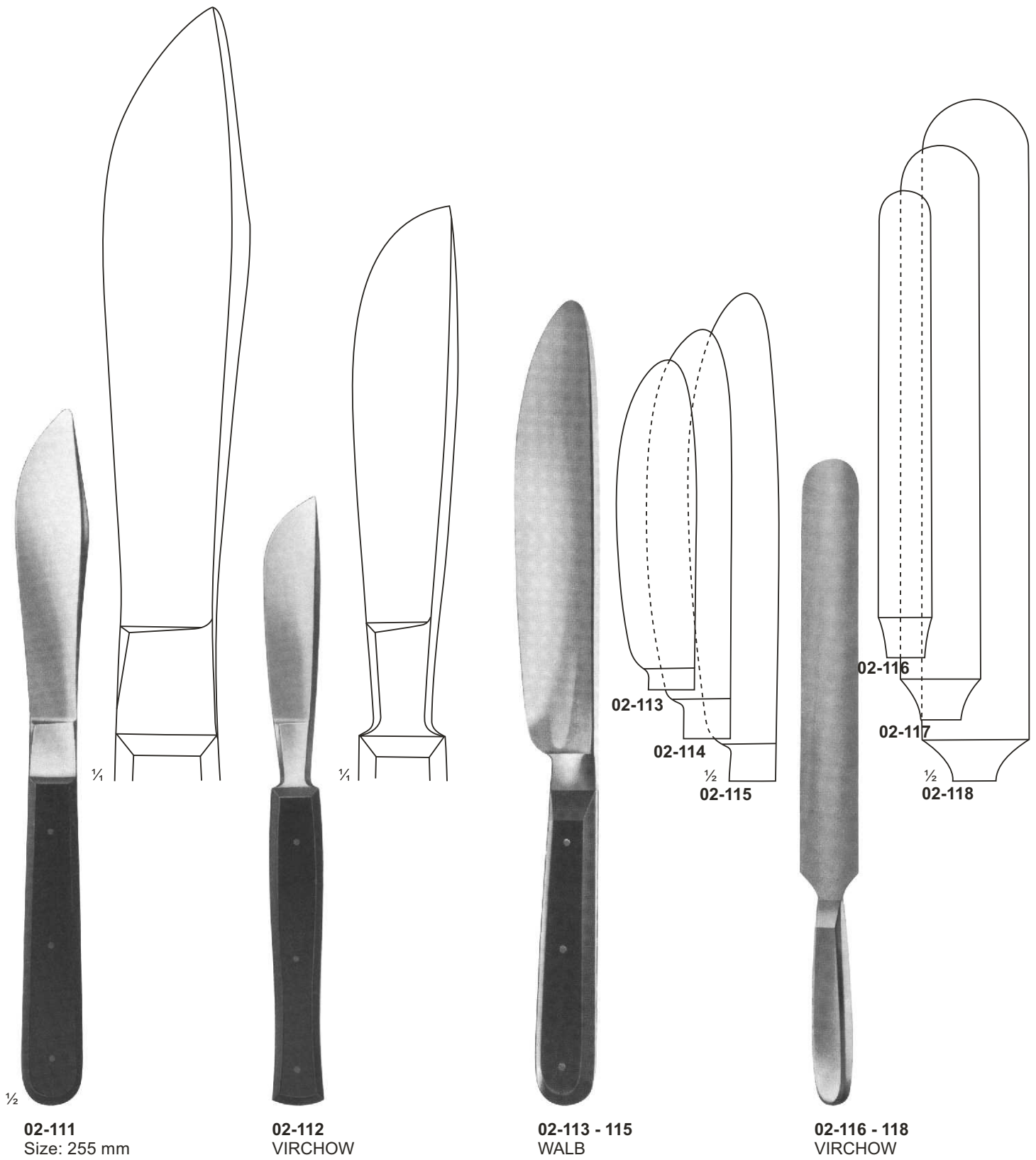

Scalpels, Tenotomes & Resection Knives

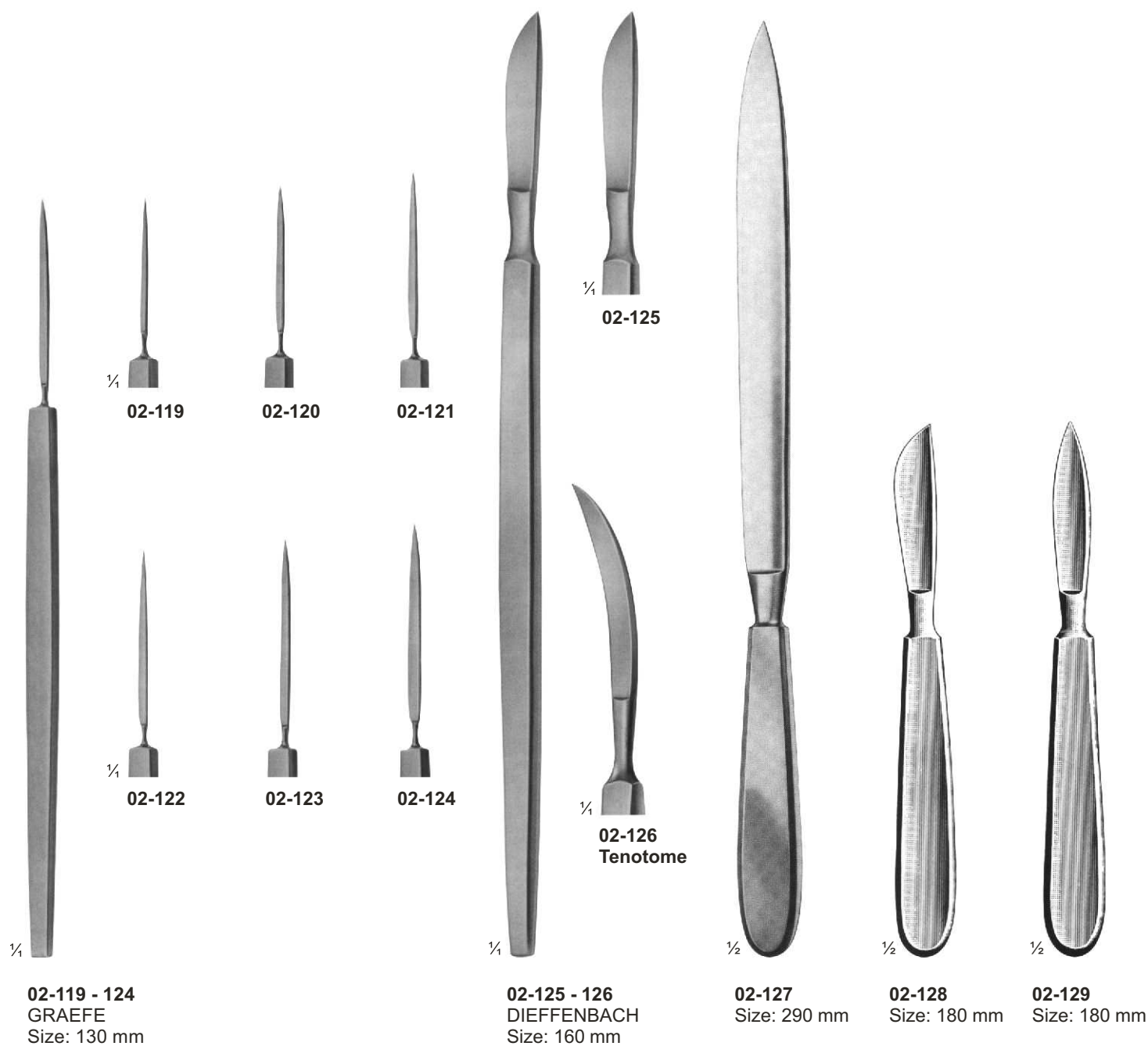

Scalpels, Tenotomes

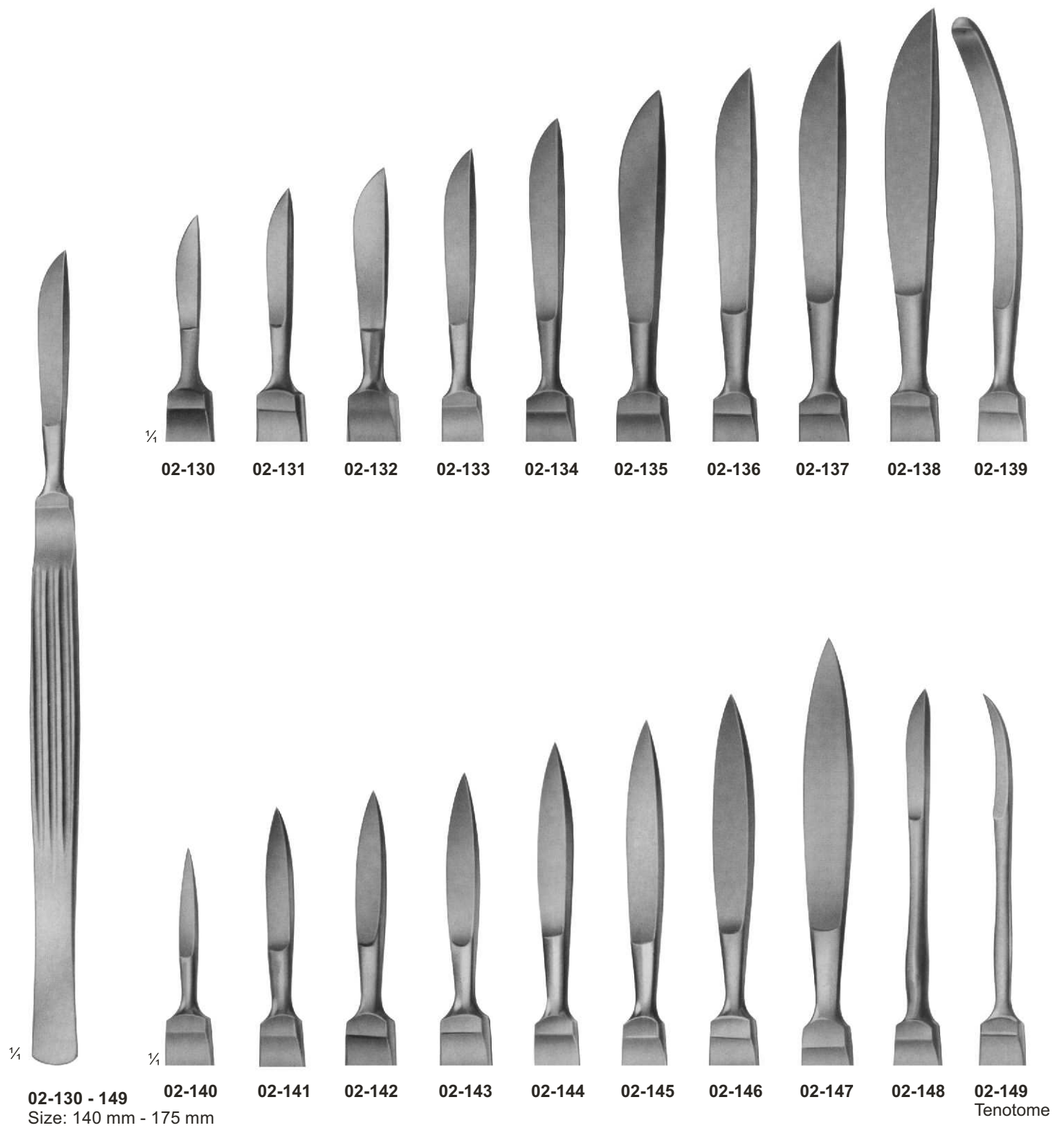

Amputating Knives, Cartilage Knives, Autopsy Knives



02-150

Size: 130 mm

02-151

Size: 160 mm

02-152

Size: 190 mm

02-153

Size: 200 mm

Blade Length
Amputating Knives

02-154

CATLIN

Size: 160 mm

Blade Length

Amputating

Knives

02-155

LANGENBECK

Size: 120 mm

Blade Length

Flap Knives

02-156

Size: 110 mm

Blade Length

Interosseous

Knives

02-157

Size: 55 mm

Blade Length

With Raspatory,

Wooden Handle

02-158

Size: 70 mm

Blade Length

Wooden Handle

02-159

Size: 80 mm

Blade Length

Metal Handle

02-160

Size: 195 mm

Blade Length

Metal Handle

Cone Knives, Myomatome, Trigeminal & Tonsil Knives



Scalpels, Dura Knives & Comedone Extractors

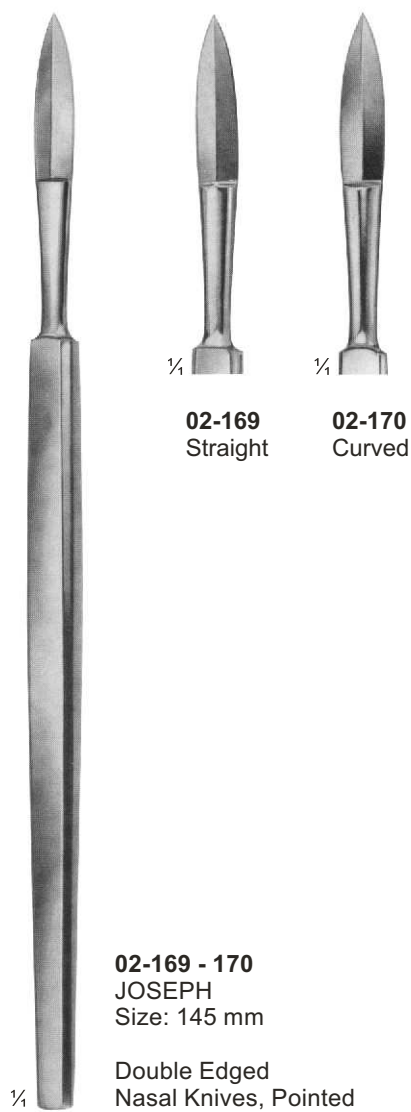

02-169
Straight

02-170
Curved

02-169 - 170
JOSEPH
Size: 145 mm

Double Edged
Nasal Knives, Pointed

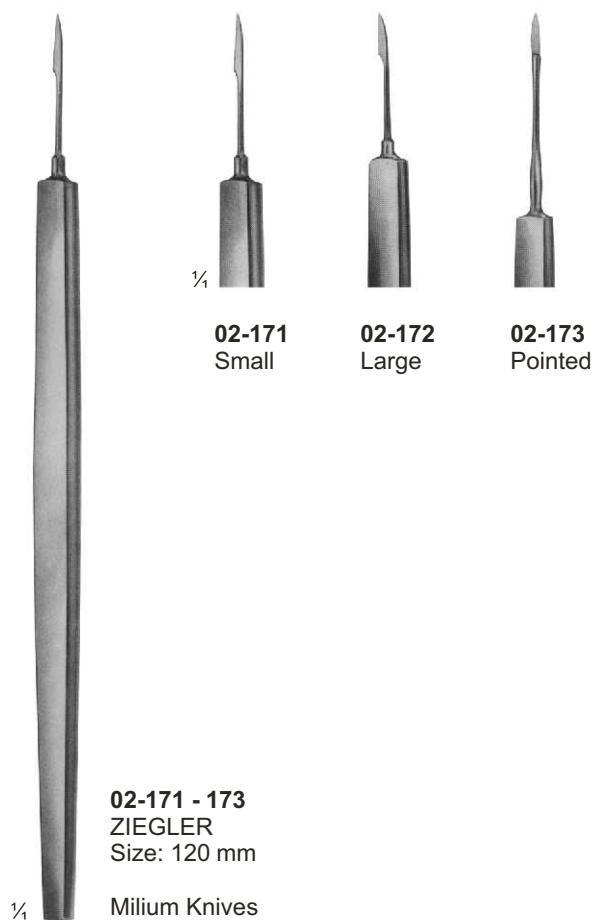

02-171
Small

02-172
Large

02-173
Pointed

02-171 - 173
ZIEGLER
Size: 120 mm

Milium Knives



02-174
VIDAL
Lupus Scraper
Size: 135 mm

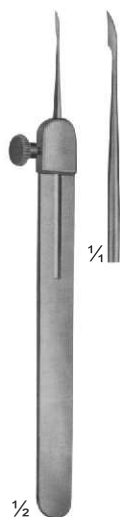

02-175
MONCORPS
Milium Knives
Size: 130 mm



02-176
SAALFELD
Size: 100 mm

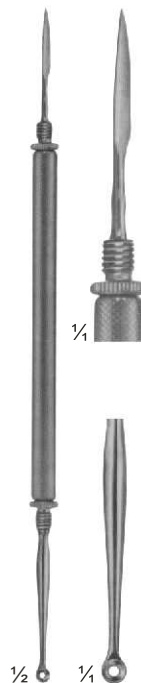

02-177
HEBRA
Size: 180 mm

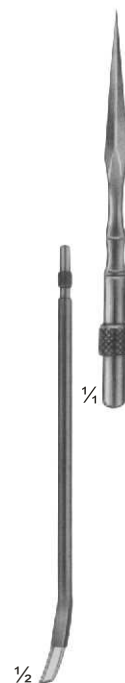

02-178
Size: 145 mm



02-179
UNNA
Size: 145 mm

Razor Blade Holders & Breakers



02-180
TROUTMAN-CHRIS
Size: 100 mm



02-181
TROUTMAN-CHRIS
Size: 100 mm



02-182
Size: 110 mm

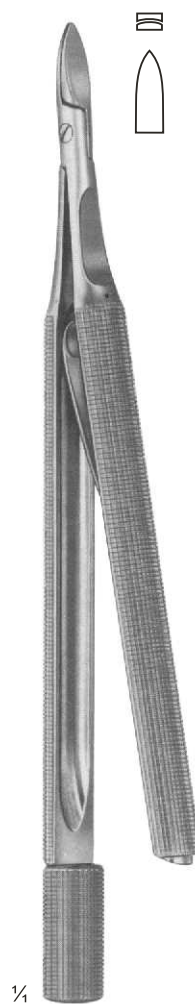

02-183
CASTROVIEJO
Size: 130 mm



02-184
Size: 185 mm

Scalpel Handles

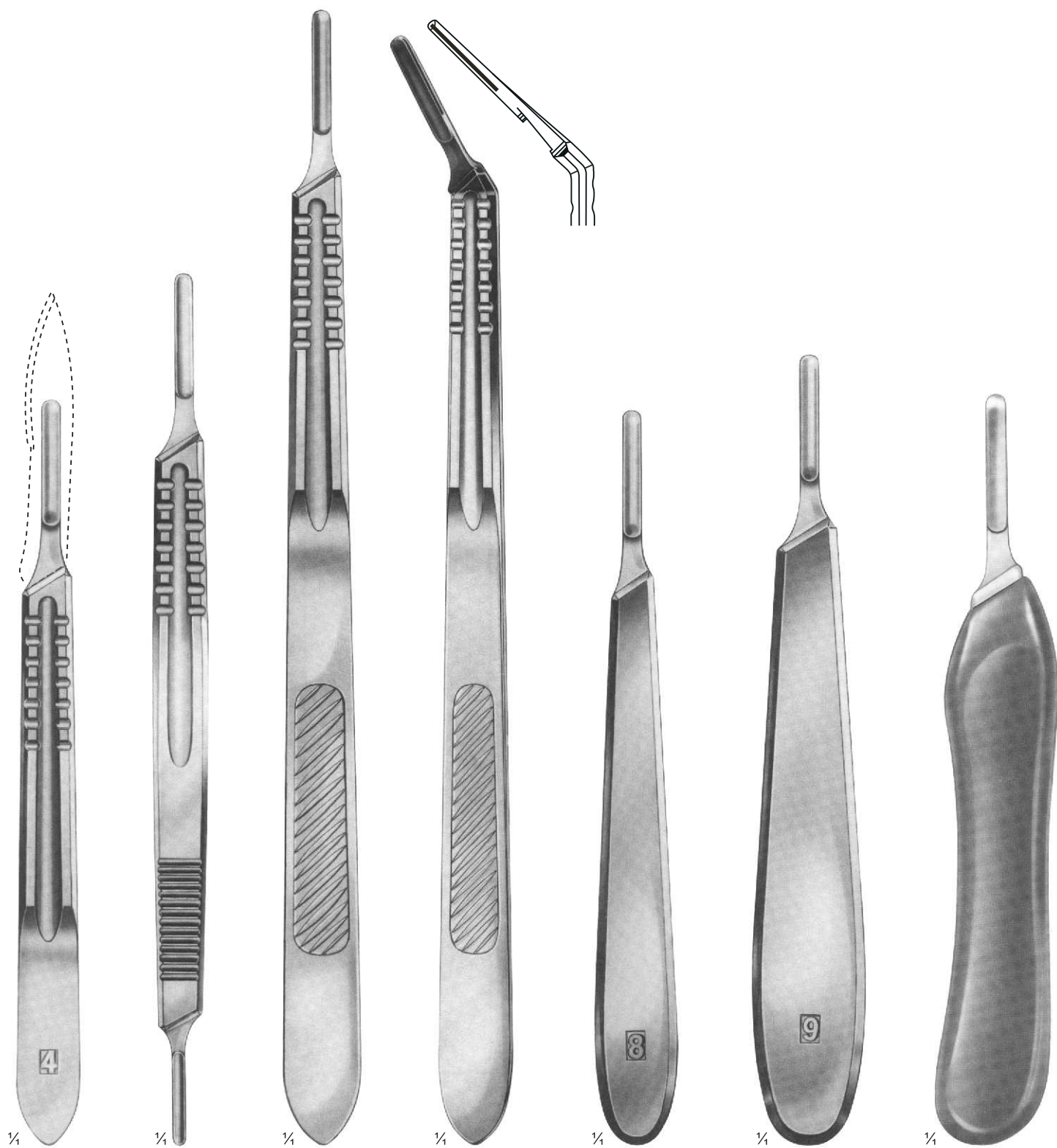

02-185
STANDARD
No. 4
Solid

02-186
Double Handel
No. 4 + No. 3
Solid

02-187
No. 4 L
Straight
Solid

02-188
No. 4 L
Solid Angled

02-189
COLLIN
No. 8
Hollow

02-190
COLLIN
No. 9
Hollow

02-191
Plastic

Scalpel Handles

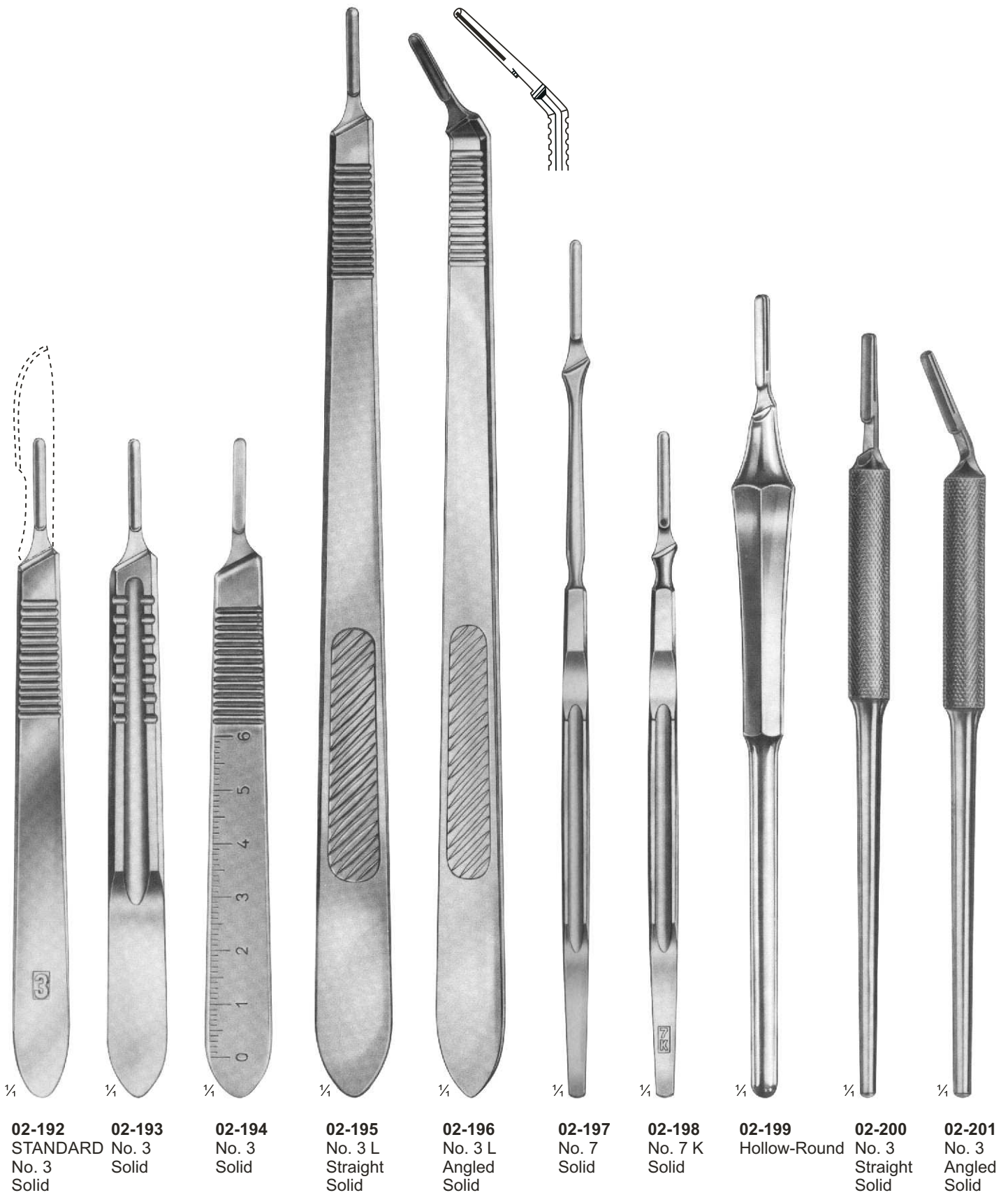

02-192
STANDARD
No. 3
Solid

02-193
No. 3
Solid

02-194
No. 3
Solid

02-195
No. 3 L
Straight
Solid

02-196
No. 3 L
Angled
Solid

02-197
No. 7
Solid

02-198
No. 7 K
Solid

02-199
Hollow-Round

02-200
No. 3
Straight
Solid

02-201
No. 3
Angled
Solid

Micro Scissors, "Spring Type" Flat Handles

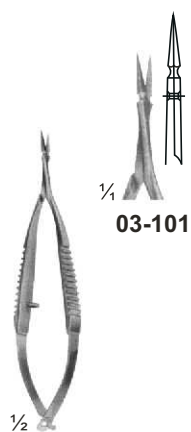

03-101 - 103
VANNAS
Size: 85 mm



03-102



03-103



03-104 - 105
CASTROVIEJO
Size: 95 mm

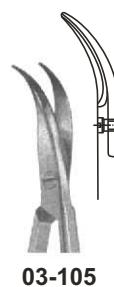

03-105

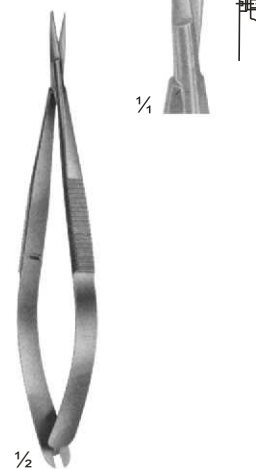

03-106
NOYES
Size: 125 mm

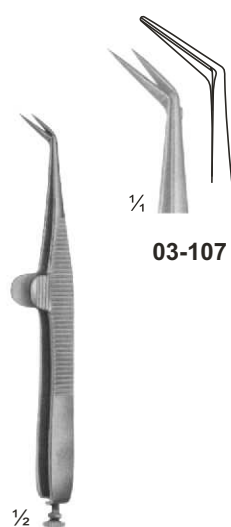

03-107 - 108
WECKER
Eye Scissor
Size: 110 mm

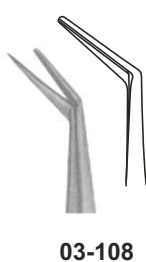

03-108

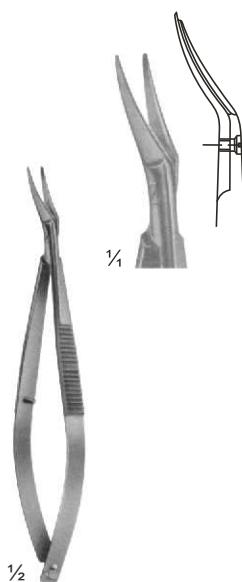

03-109
CASTROVIEJO
Eye Scissor
Size: 115 mm

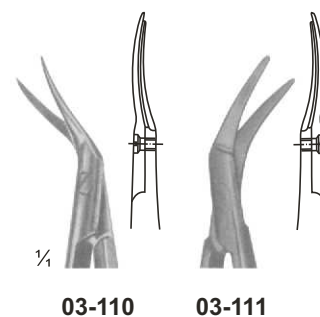

03-110 - 111
CASTROVIEJO
Eye Scissor
Size: 110 mm

03-110

03-111

Micro Scissors, "Spring Type" Flat Handles

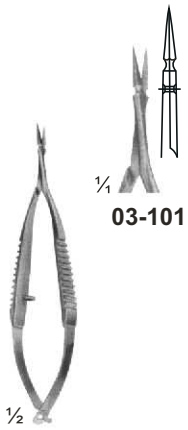

03-101 - 103
VANNAS
Size: 85 mm



03-101



03-102



03-103

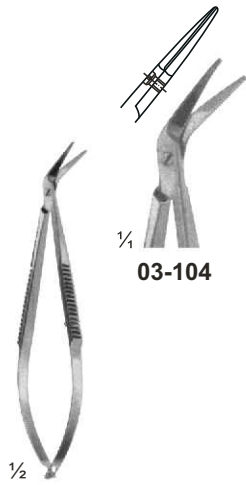

03-104 - 105
CASTROVIEJO
Size: 95 mm

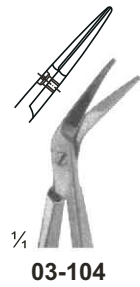

03-104



03-105



03-106
NOYES
Size: 125 mm

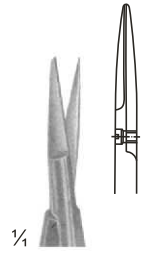

1/4

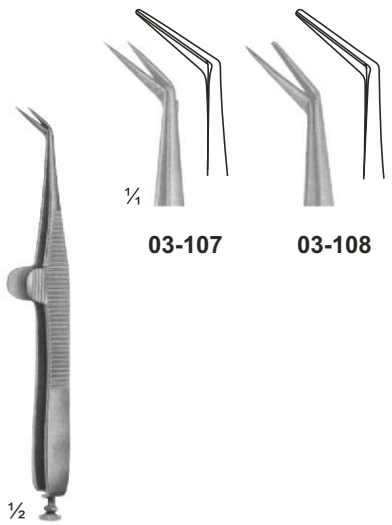

03-107 - 108
WECKER
Eye Scissor
Size: 110 mm



03-107

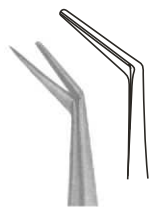

03-108

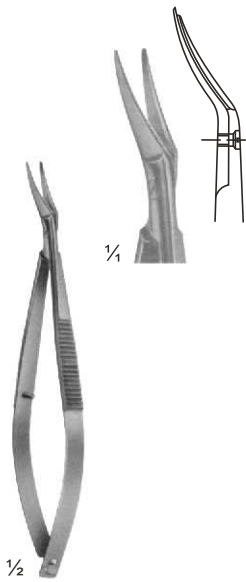

03-109
CASTROVIEJO
Eye Scissor
Size: 115 mm

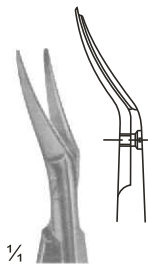

1/4

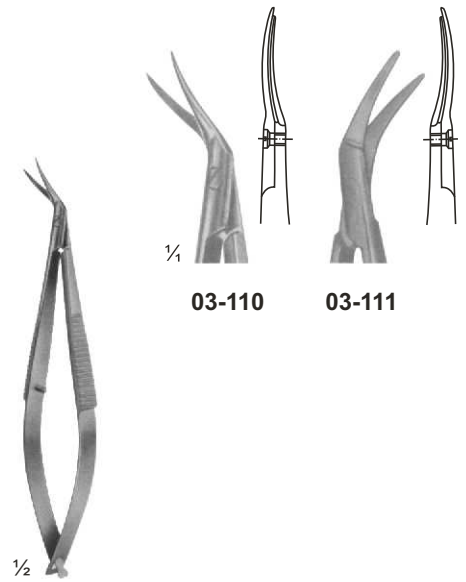

03-110 - 111
CASTROVIEJO
Eye Scissor
Size: 110 mm

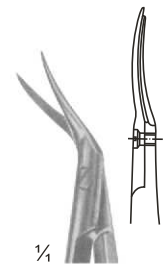

03-110



03-111

Micro Scissors, "Spring Type" Flat Handles

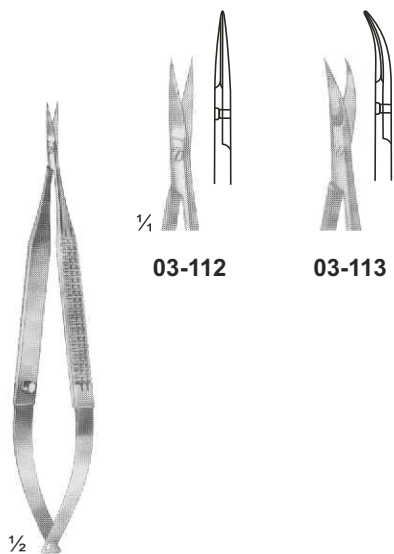

03-112
03-113

03-112 - 113
Size: 120 mm

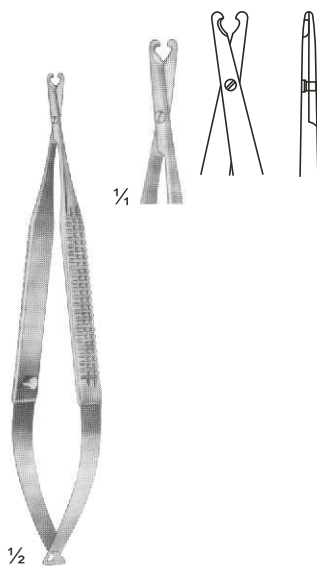

03-114
BIEMER
Vein Scissor
Size: 130 mm

03-115
Size: 160 mm

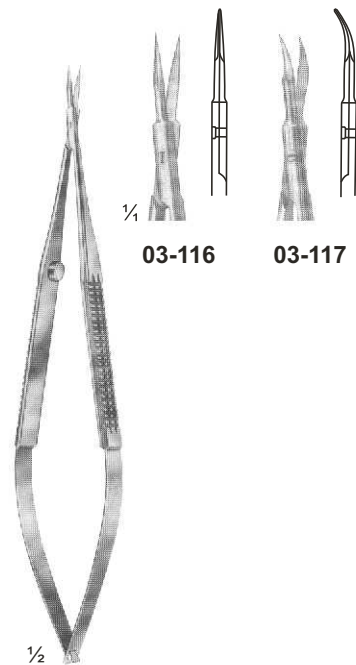

03-116
03-117

03-116 - 117
VANNAS
Size: 160 mm

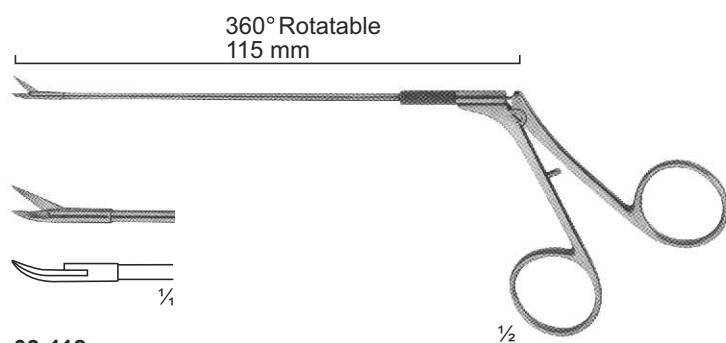

03-118
CASPAR
Micro Scissor Curved
Size: 115 mm

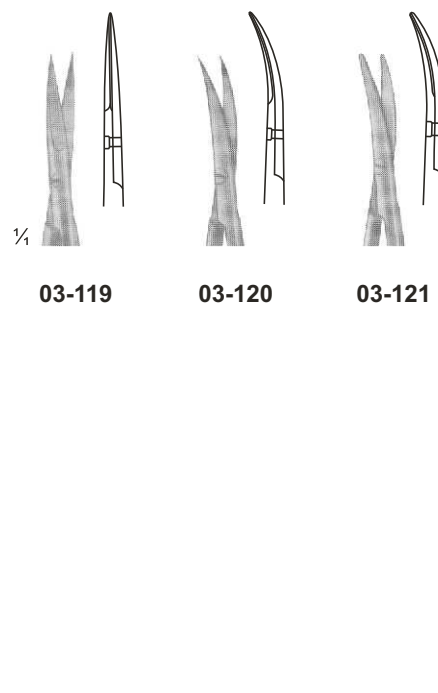

03-119
03-120
03-121

03-119 - 121
Micro Dissecting Scissor
Size: 145 mm

Micro Scissors, "Spring Type" Bayonet Shape

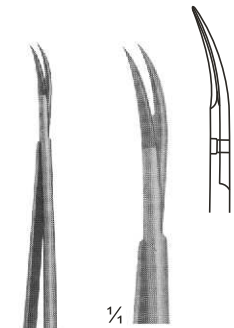

03-122
YASARGIL
Size: 245 mm

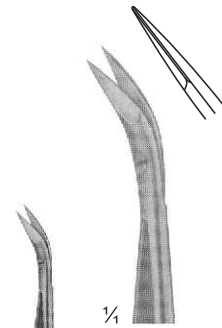

03-123

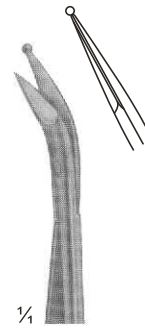

03-124



03-123 - 124
Laterally Angled
Size: 200 mm

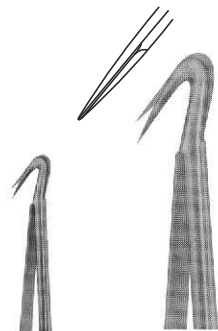

03-125
Laterally Angled
Size: 190 mm

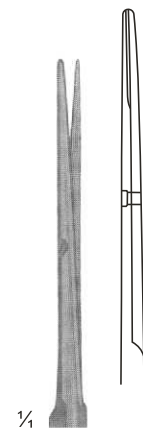

03-126

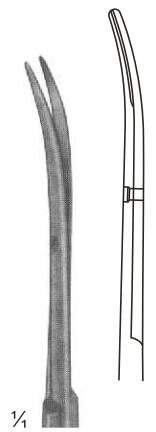

03-127



03-126 - 127
YASARGIL
Size: 225 mm

Delicate Scissors

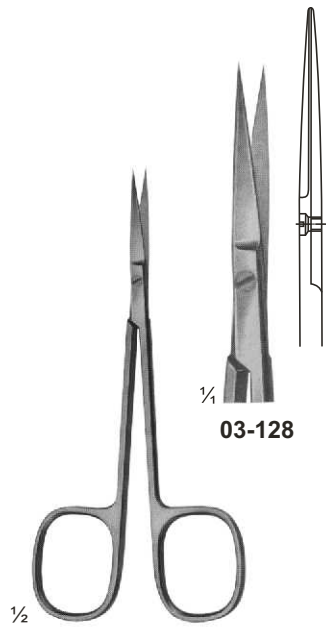

03-128

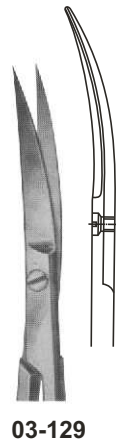

03-129

03-128 - 129
Size: 120 mm

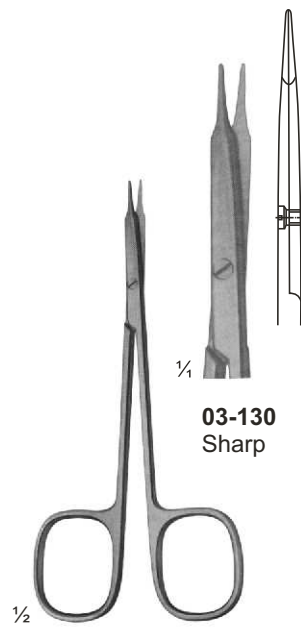

03-130
Sharp

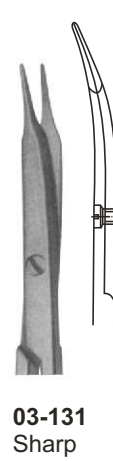

03-131
Sharp

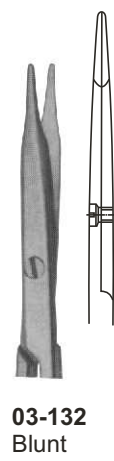

03-132
Blunt

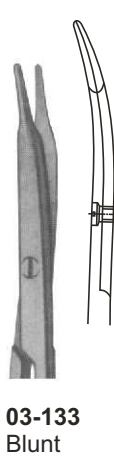

03-133
Blunt

03-130 - 133
STEVENS
Dissecting Scissors
Size: 115 mm

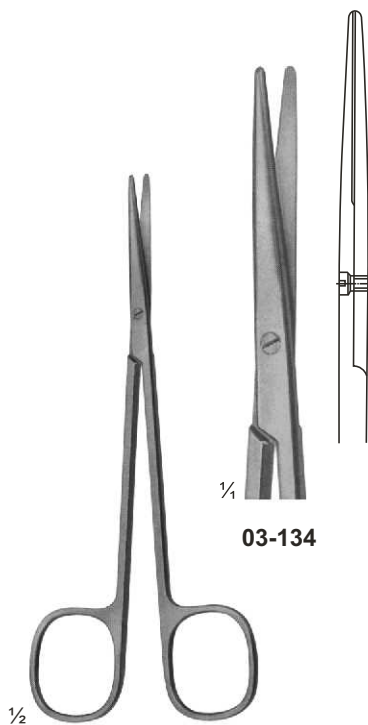

03-134

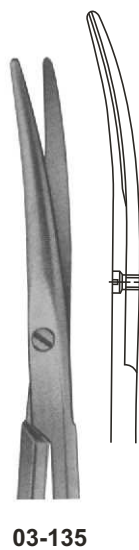

03-135

03-134 - 135
METZENBAUM
Dissecting Scissors
Size: 145 mm

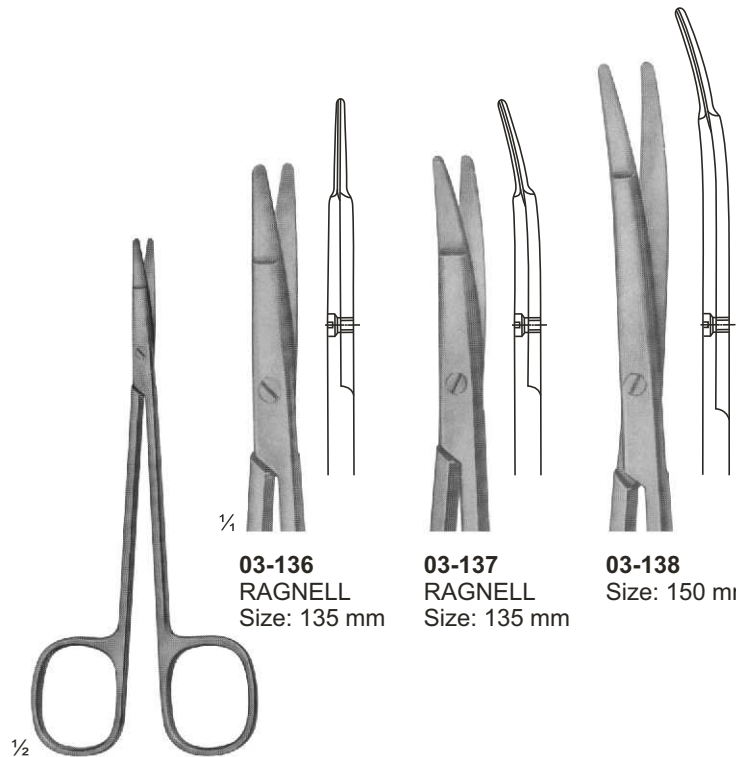

03-136
RAGNELL
Size: 135 mm

03-137
RAGNELL
Size: 135 mm

03-138
Size: 150 mm

03-136 - 138
Special flat points for
dissecting and
undermining the skin
Size: 145 mm

Delicate Scissors

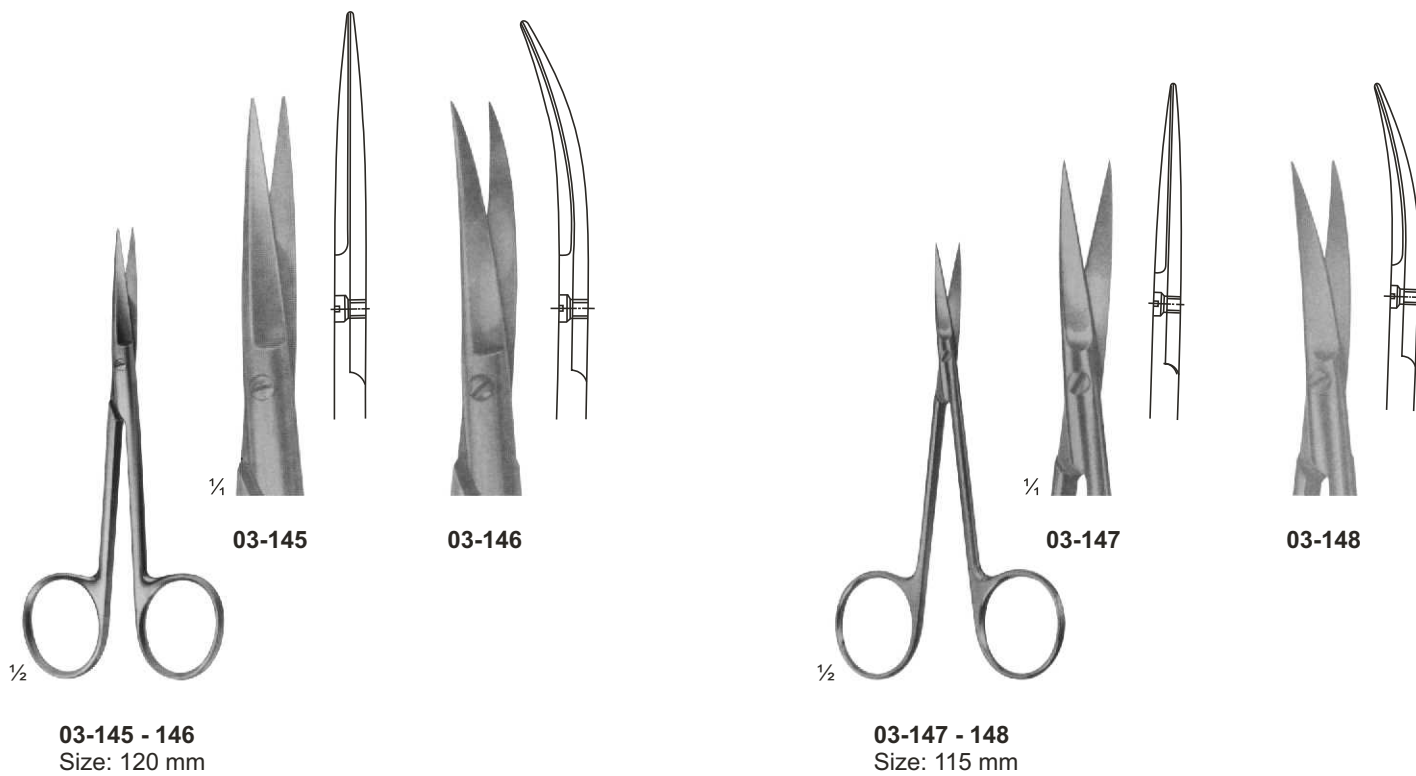
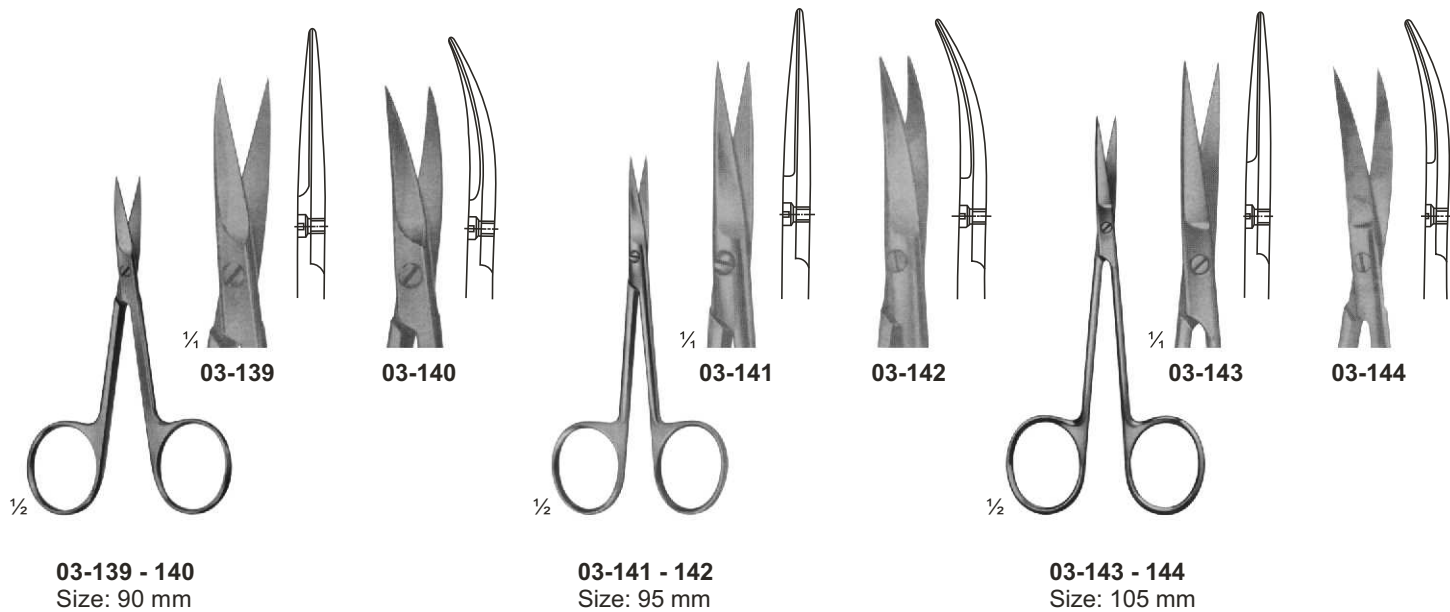

Delicate Scissors



1/2

03-149 - 151
Size: 120 mm

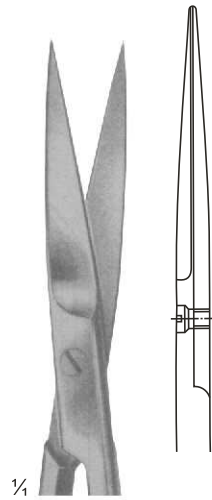

1/4

03-149

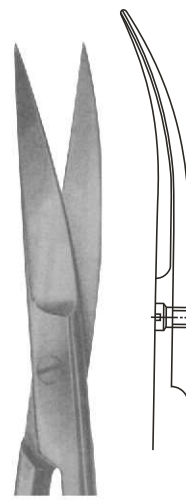

03-150

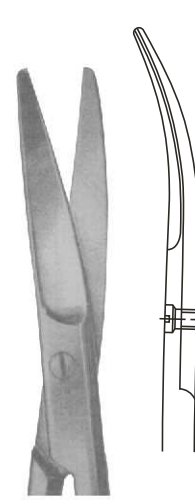

03-151



1/2

03-152 - 155
Size: 130 mm

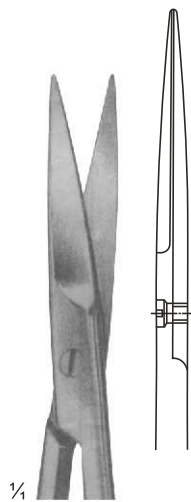

1/4

03-152

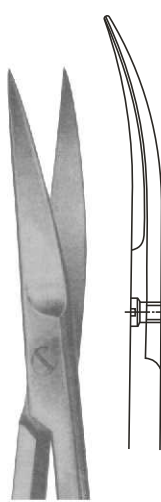

03-153

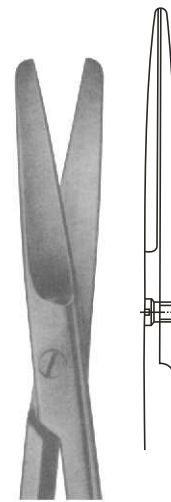

03-154

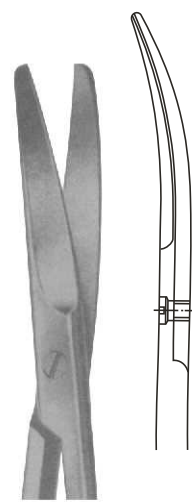

03-155

Delicate Scissors

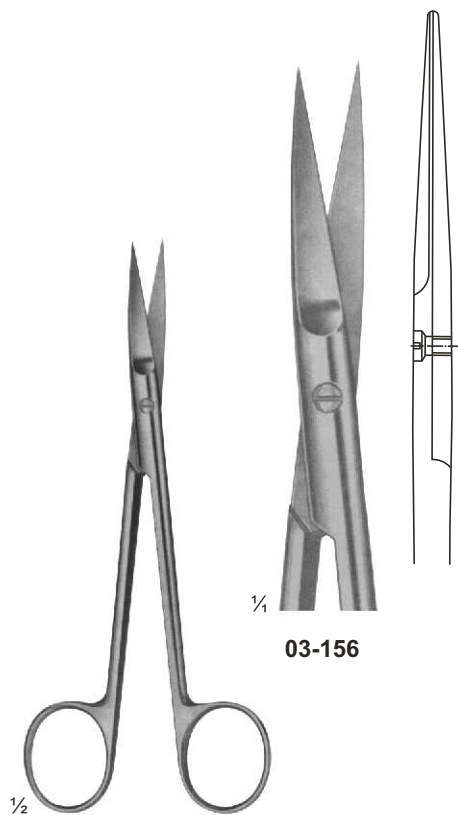

03-156 - 157
JOSEPH
Size: 150 mm

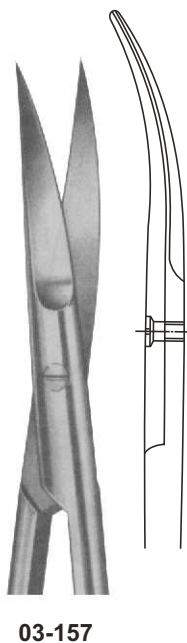

03-158 - 159
KELLY
Size: 175 mm

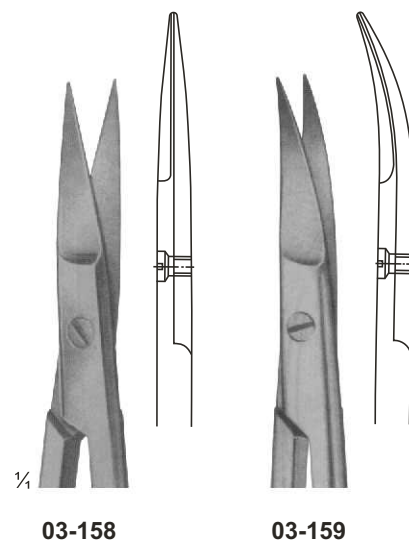

03-160
QUINBY
Size: 130 mm

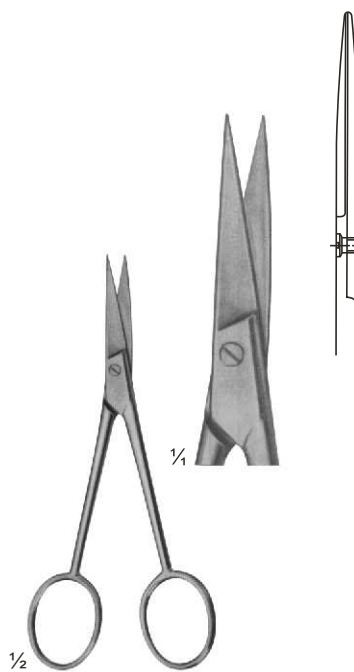

03-161
Size: 110 mm

Surgical Scissors

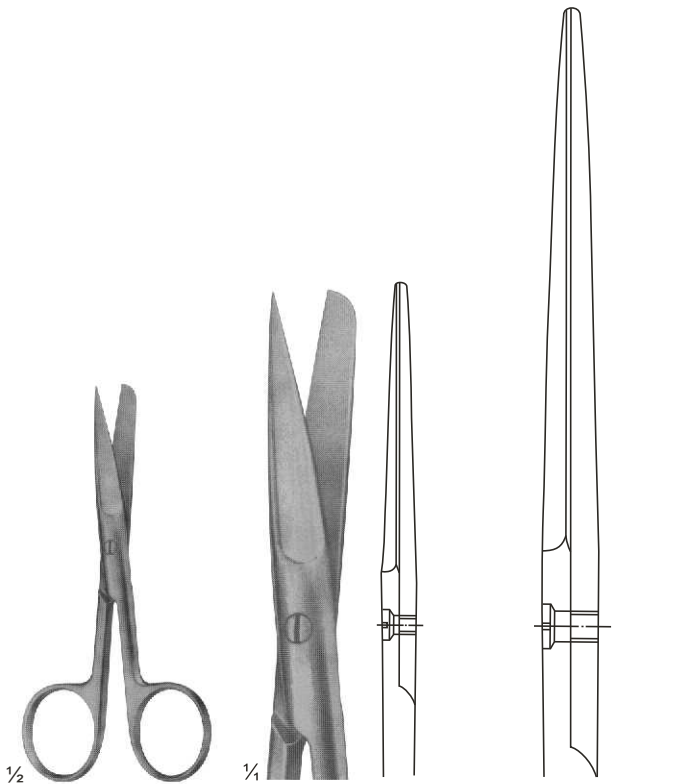

03-162 - 170 (Standard Types)
03-162 (105 mm)
03-163 (115 mm)
03-164 (130 mm)
03-165 (145 mm)
03-166 (150 mm)
03-167 (165 mm)
03-168 (175 mm)
03-169 (185 mm)
03-170 (200 mm)



03-171 - 177 (Standard Types)
03-171 (115 mm)
03-172 (130 mm)
03-173 (145 mm)
03-174 (150 mm)
03-175 (165 mm)
03-176 (175 mm)
03-177 (185 mm)

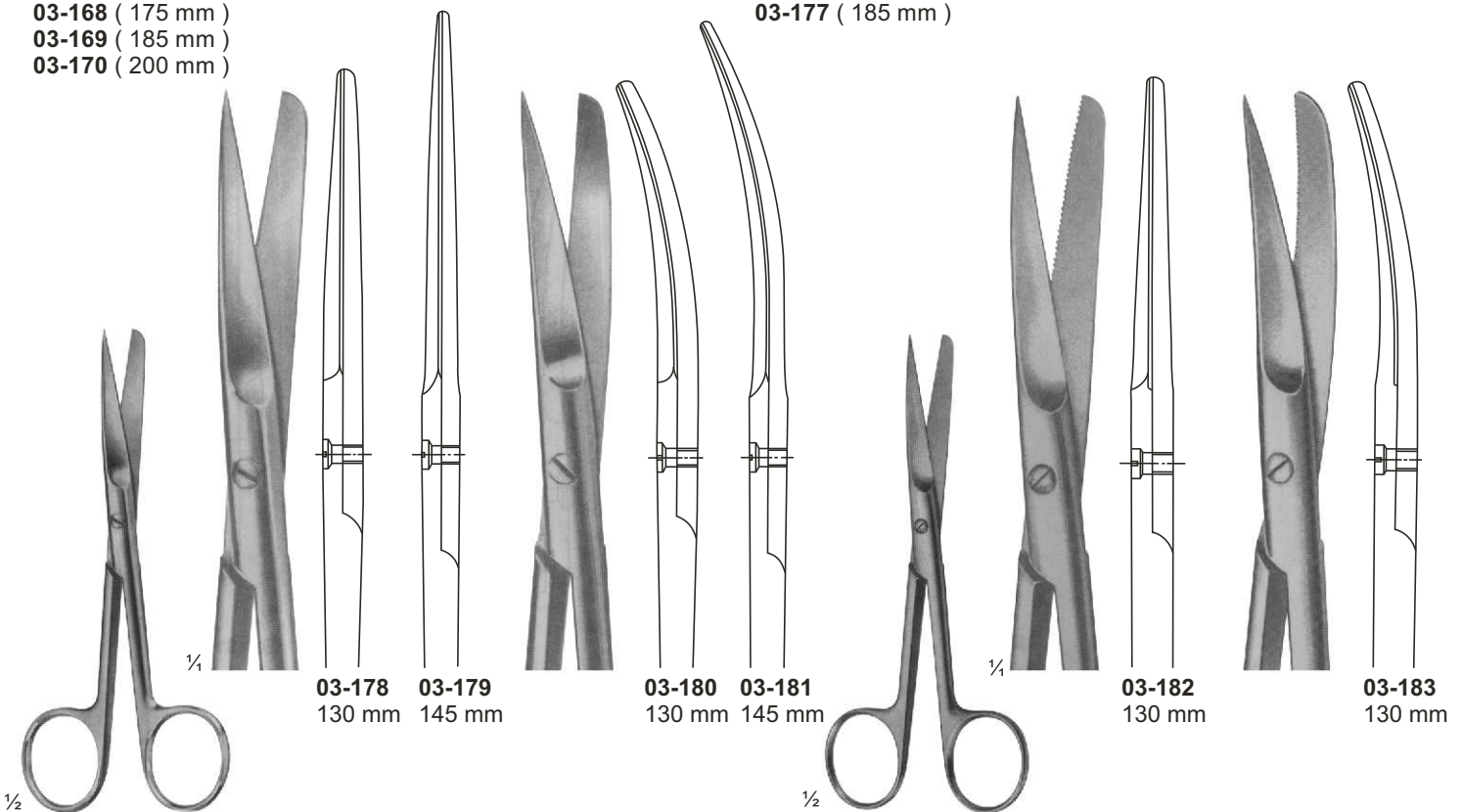

03-178 - 181
Slender Types

03-182 - 183
For Wound Edges
1 Blade Serrated

Surgical Scissors

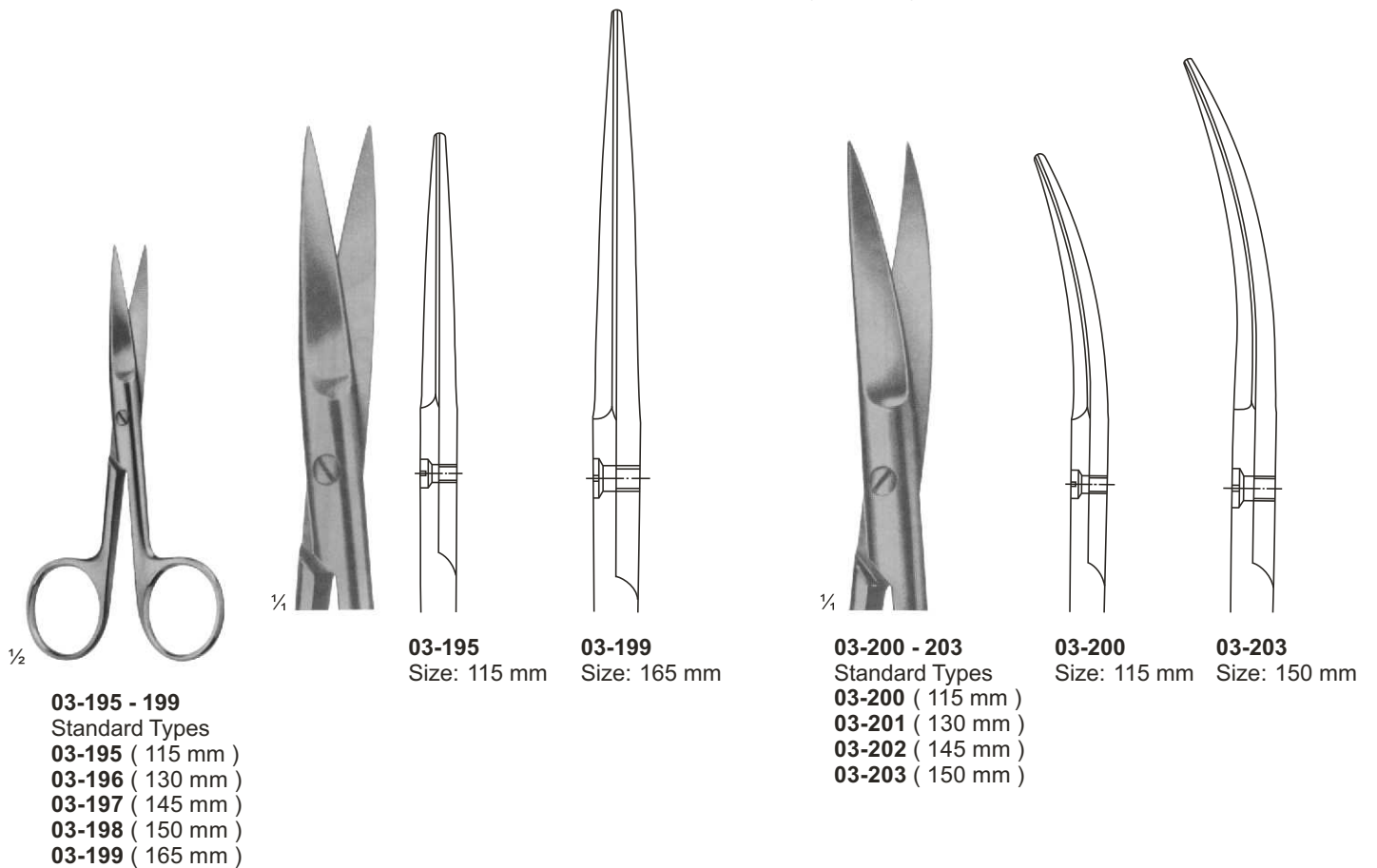
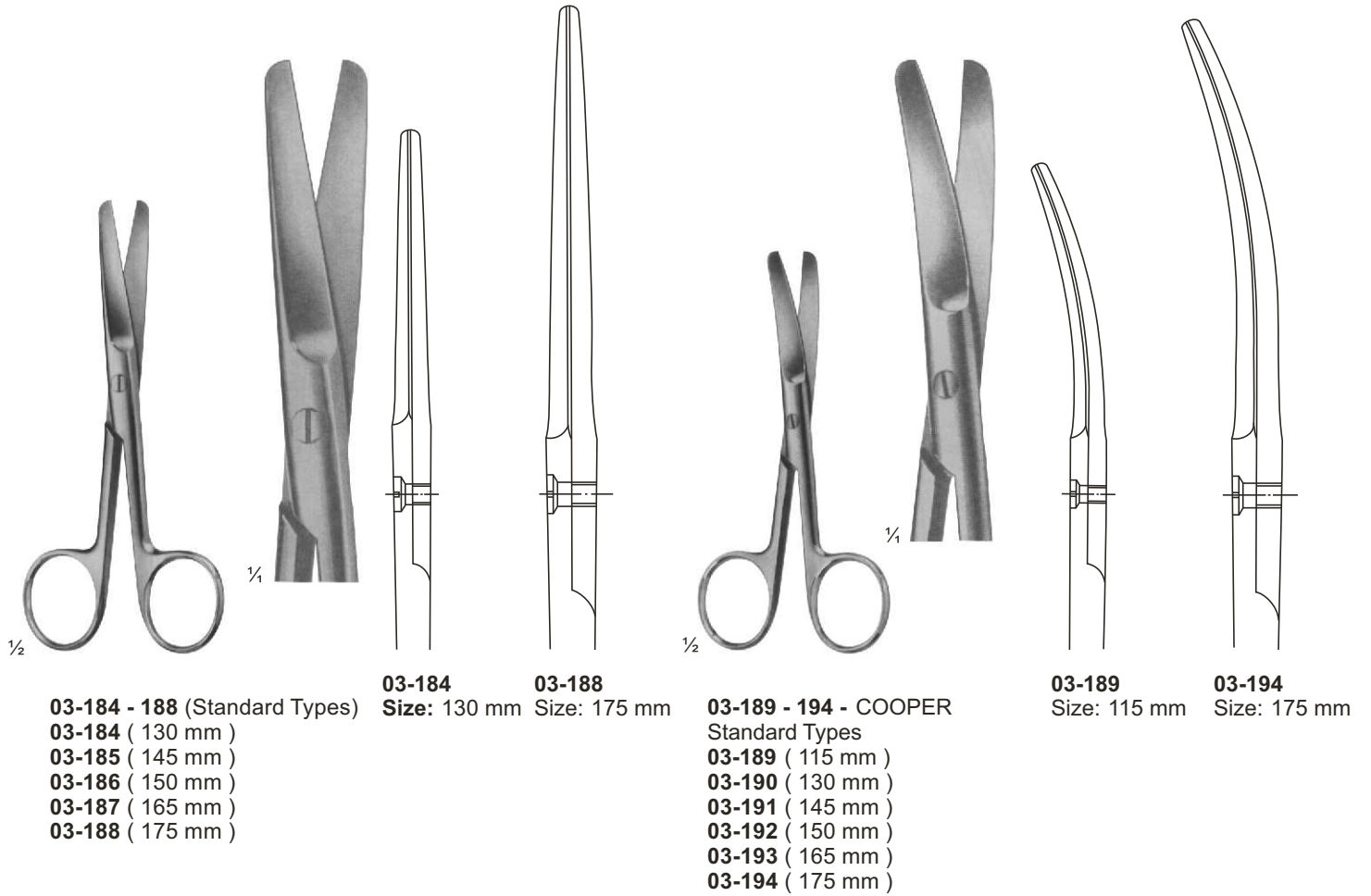

Surgical Scissors

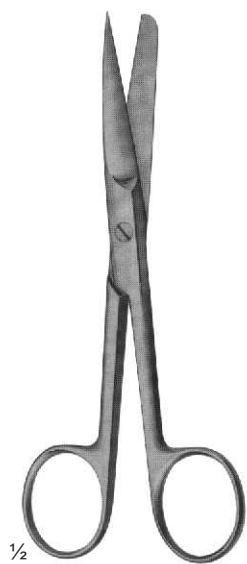

03-204 - 206
DEAVER
With flat lock

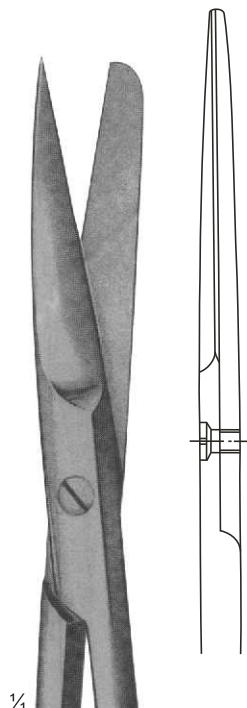

03-204
Size: 145 mm

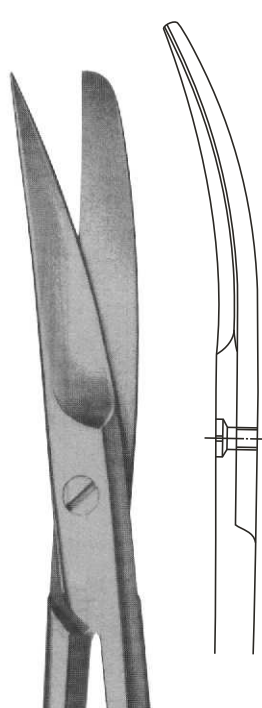

03-205
Size: 145 mm

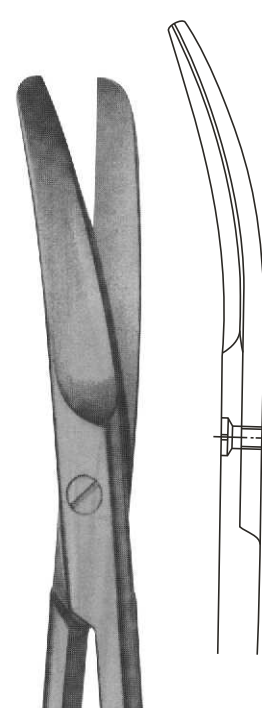

03-206
Size: 145 mm

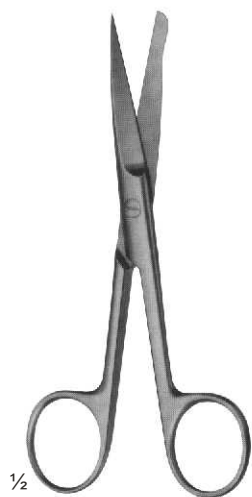

03-207 - 209
Incision Scissors

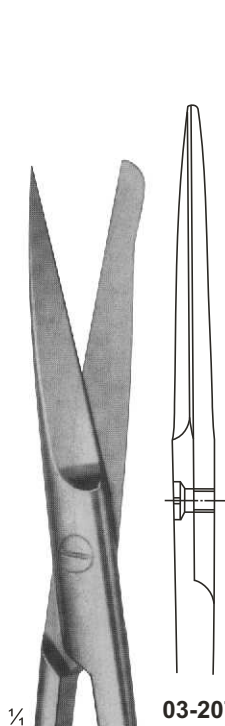

03-207
Size: 130 mm



03-208
Size: 145 mm

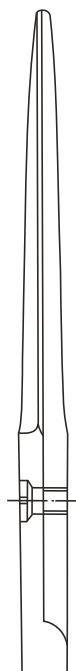

03-209
Size: 165 mm

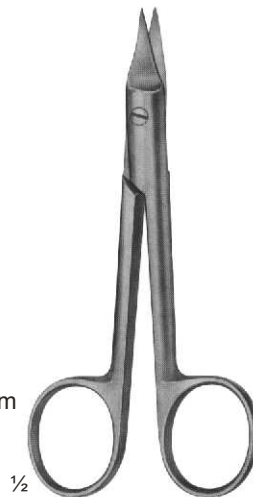

03-210
SYSTRUNK
Nail Splitting Scissors

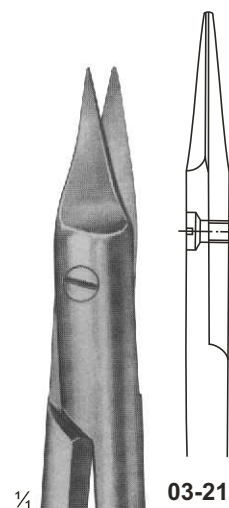

03-210
Size: 130 mm

Dissecting Scissors

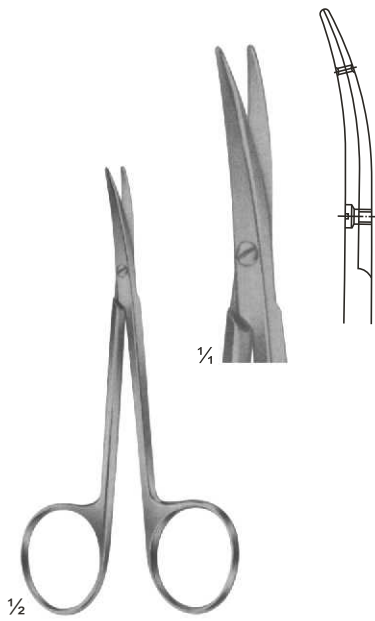

03-211
LITTLER
Dissecting Scissors
Tips with eye for suture
Size: 115 mm

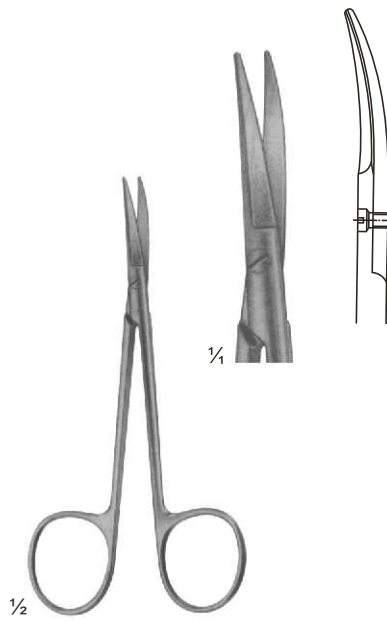

03-212
COTTLE
Bulldog Scissors
Size: 115 mm

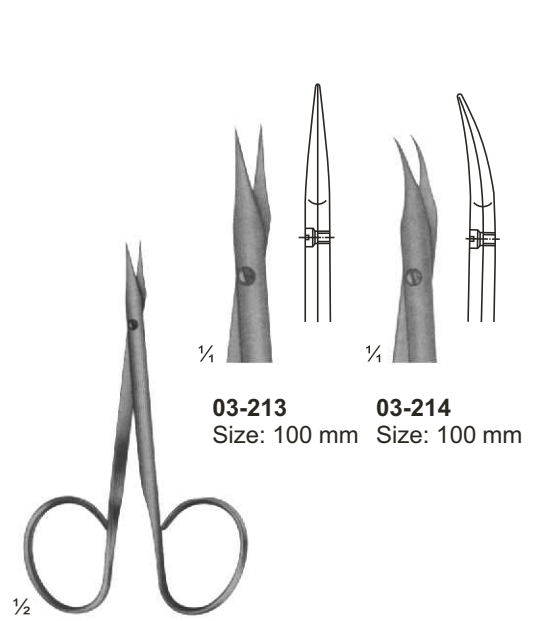

03-213 - 214
STEVENS
Vessel and tendon Scissors
Size: 100 mm

03-213 **03-214**
Size: 100 mm Size: 100 mm

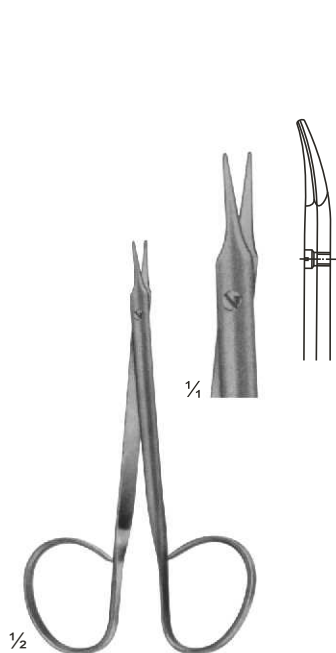

03-215
STEVENS
Fine Dissecting Scissors
Size: 110 mm

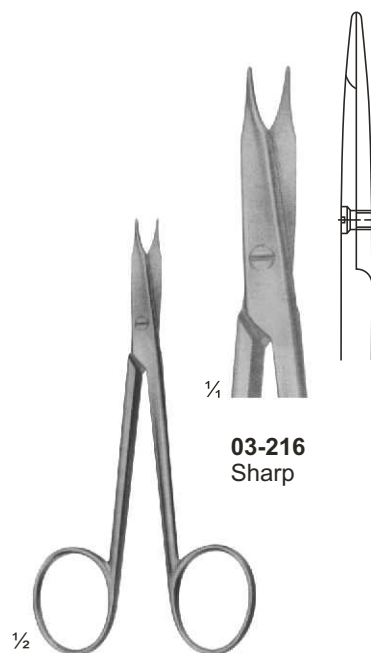

03-216 - 219
STEVENS
Vessel and tendon Scissors
Size: 110 mm

03-216
Sharp

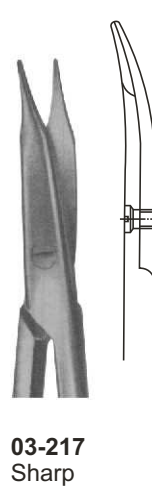

03-217
Sharp

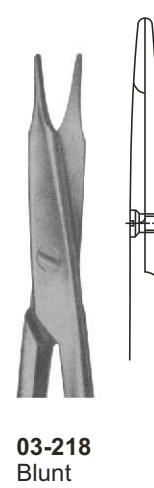

03-218
Blunt

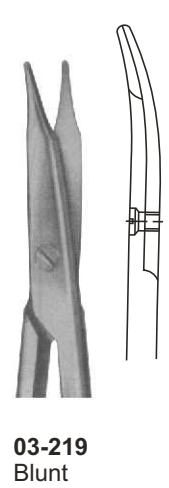

03-219
Blunt

Dissecting Scissors

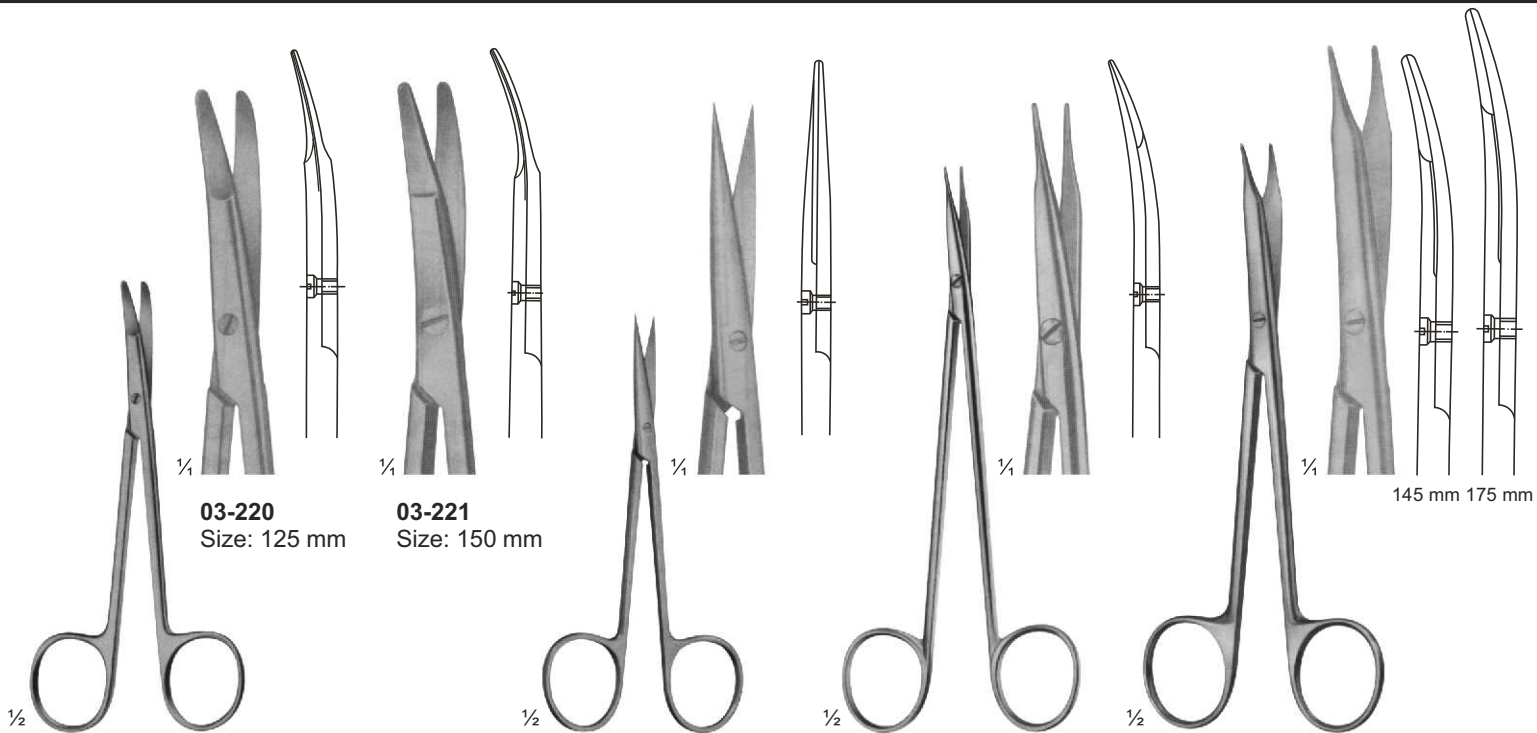

03-220 - 221
KILNER
Special flat points for dissecting and undermining the skin

03-222
KILNER
Fine dissecting scissors
Size: 115 mm

03-223
JAMESON
Dissecting scissors
Size: 150 mm

03-224
REYNOLDS
Dissecting scissors
Size: 145 - 175 mm

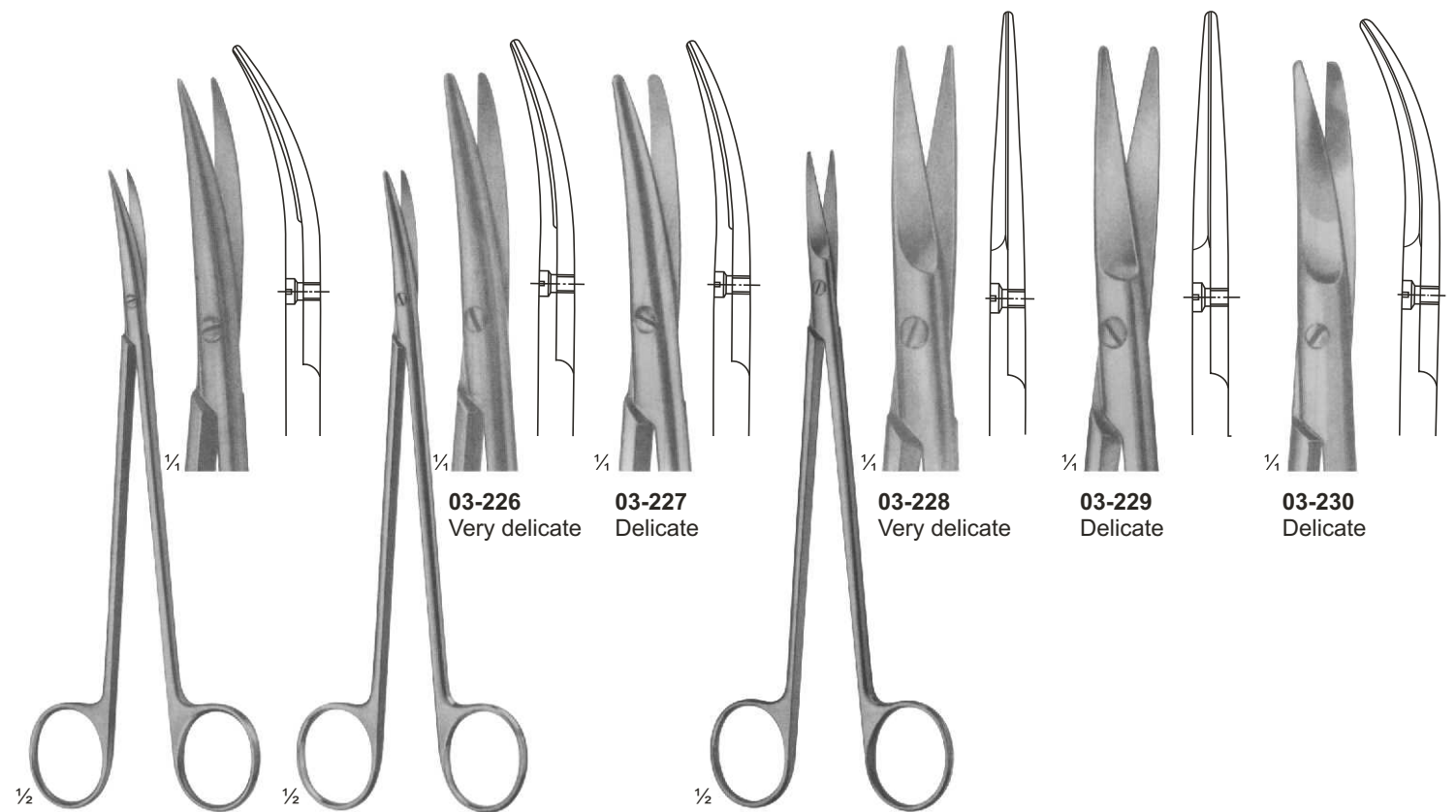

03-225
DE BAKEY
Ateriotomy scissors
Size: 175 mm

03-226 - 227
TOENNISADSON
Dissecting scissors
Size: 175 mm

03-228 - 230
TOENNIS
Dissecting scissors
Size: 150 mm

Dissecting & Surgical Scissors

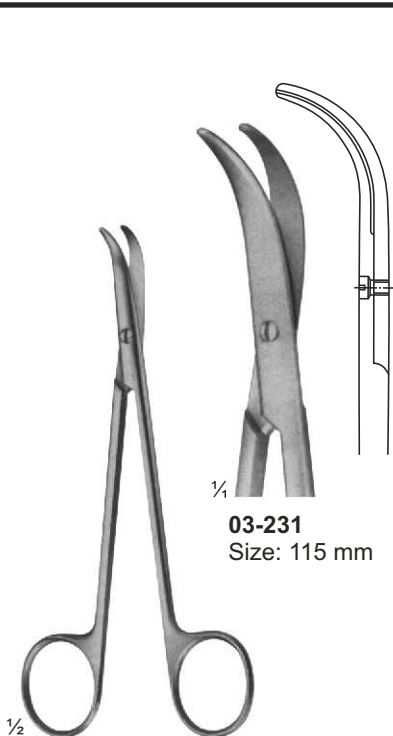

03-231
Size: 115 mm

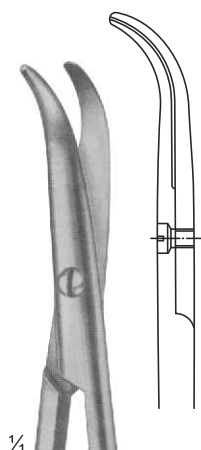

03-232
Size: 135 mm

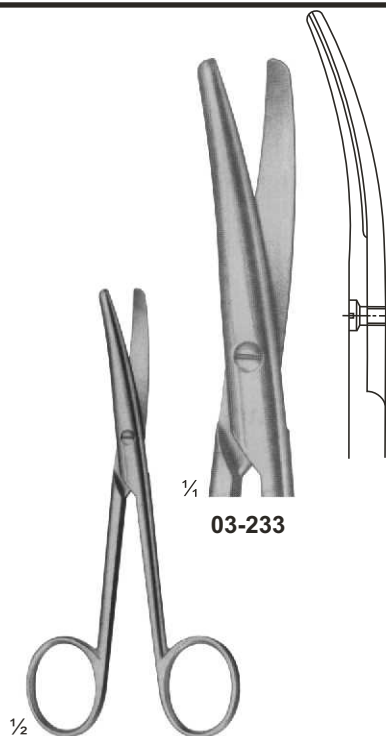

03-233

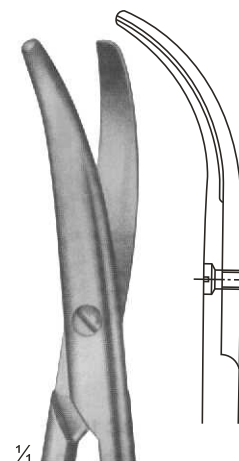

03-234

03-231 - 232
FOMON
Lower lateral scissors

03-233 - 234
LANDOLT
Enucleation scissors
Size: 120 mm

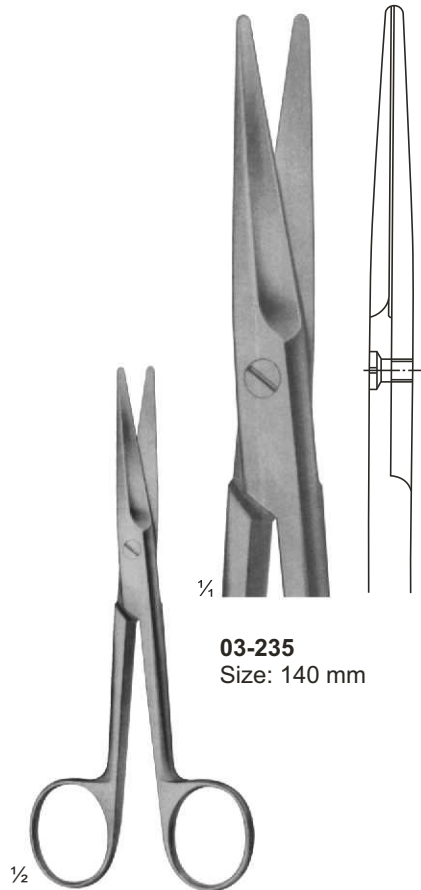

03-235
Size: 140 mm

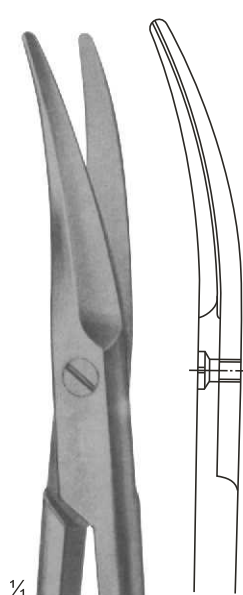

03-238 - 240
MAYO
03-238 (140 mm)
03-239 (155 mm)
03-240 (170 mm)

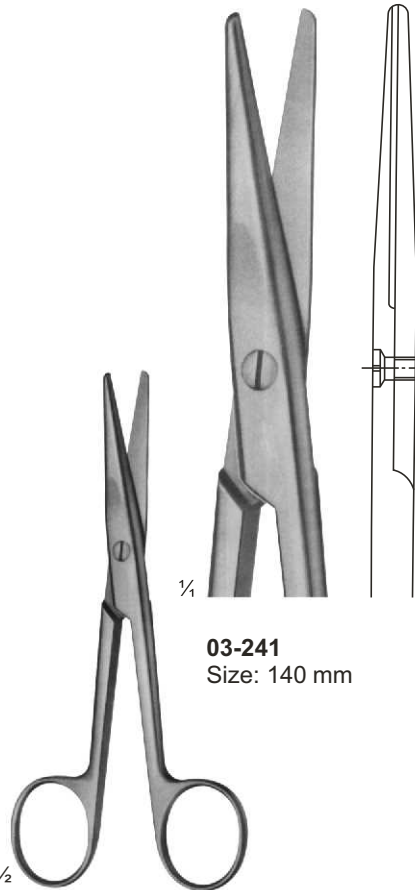

03-241
Size: 140 mm

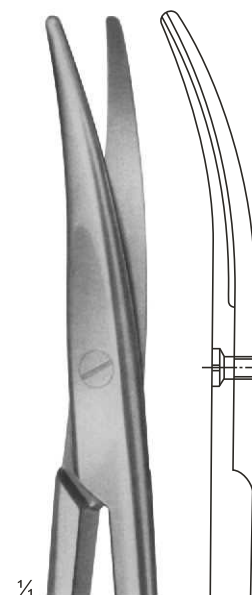

03-243 - 244
MAYO-STILLE
03-243 (140 mm)
03-244 (170 mm)

03-235 - 237
MAYO
03-235 (140 mm)
03-236 (155 mm)
03-237 (170 mm)

03-241 - 242
MAYO-STILLE
03-241 (140 mm)
03-242 (170 mm)

Dissecting Scissors

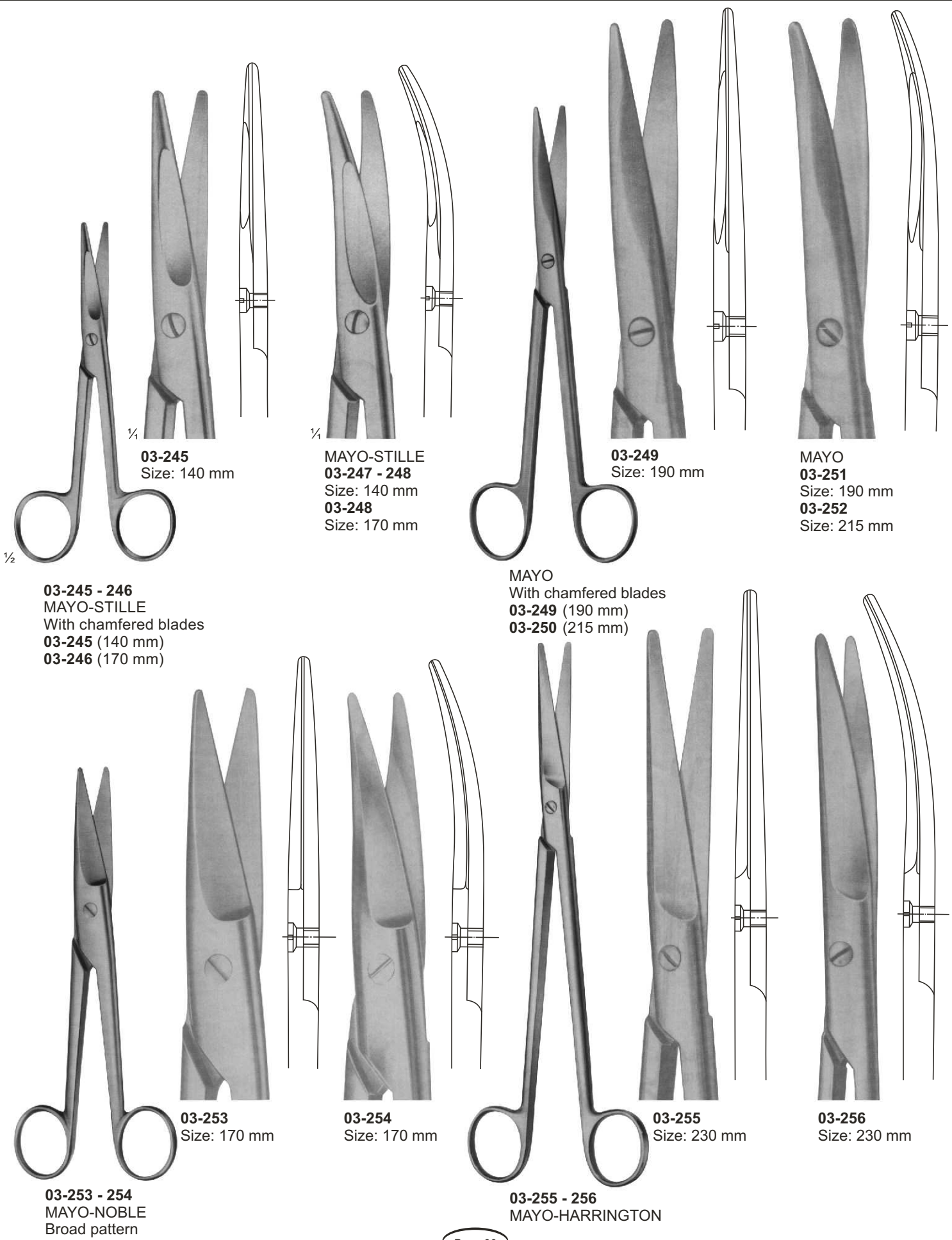

03-245
Size: 140 mm

MAYO-STILLE
03-247 - 248
Size: 140 mm
03-248
Size: 170 mm

03-249
Size: 190 mm

MAYO
03-251
Size: 190 mm
03-252
Size: 215 mm

03-245 - 246
MAYO-STILLE
With chamfered blades
03-245 (140 mm)
03-246 (170 mm)

MAYO
With chamfered blades
03-249 (190 mm)
03-250 (215 mm)

03-253
Size: 170 mm

03-254
Size: 170 mm

03-255
Size: 230 mm

03-256
Size: 230 mm

03-253 - 254
MAYO-NOBLE
Broad pattern

03-255 - 256
MAYO-HARRINGTON

Dissecting Scissors

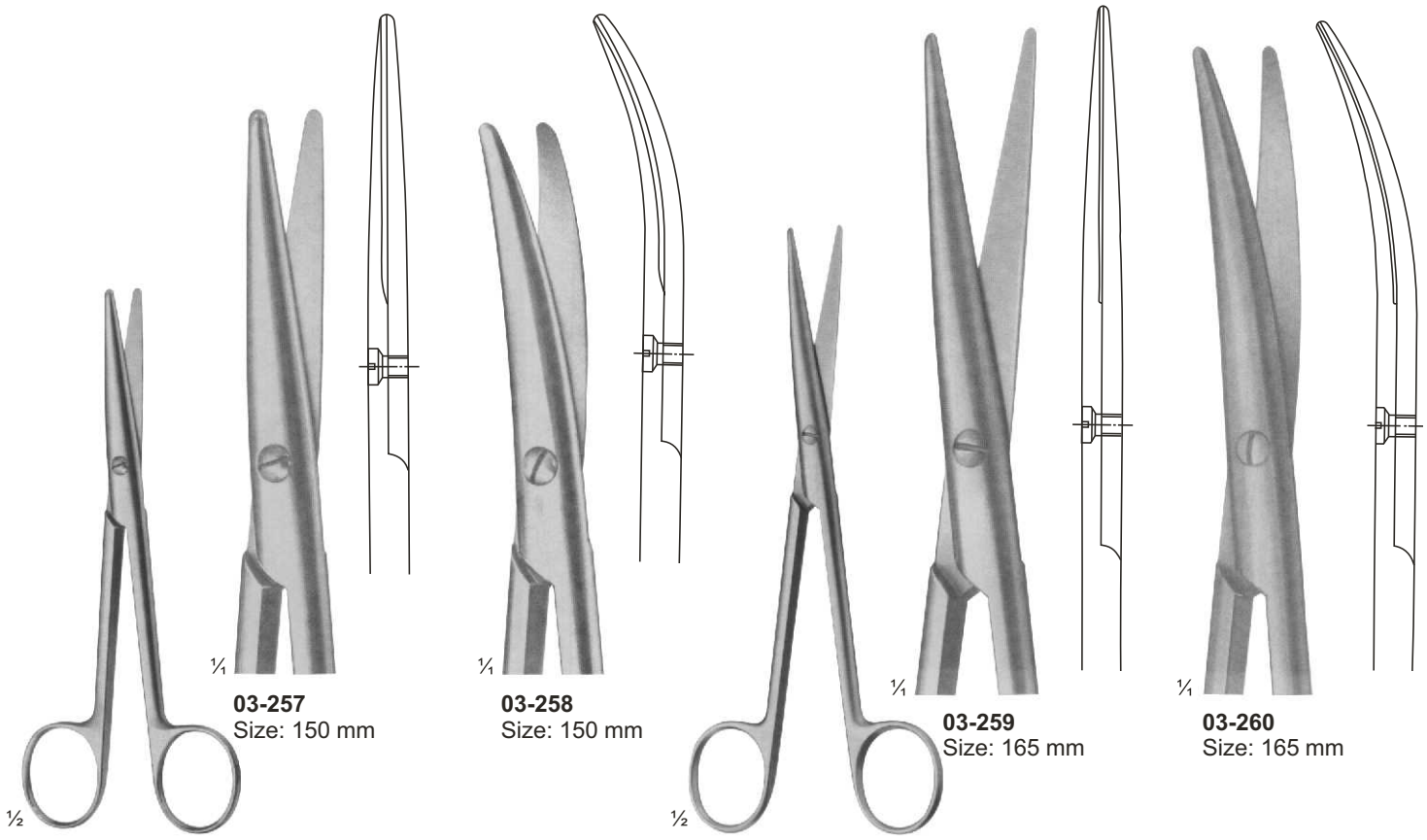

03-257
Size: 150 mm

03-258
Size: 150 mm

03-259
Size: 165 mm

03-260
Size: 165 mm

03-257 - 258
STILLE
Size: 150 mm

03-259 - 260
LEXER
Narrow
Size: 165 mm

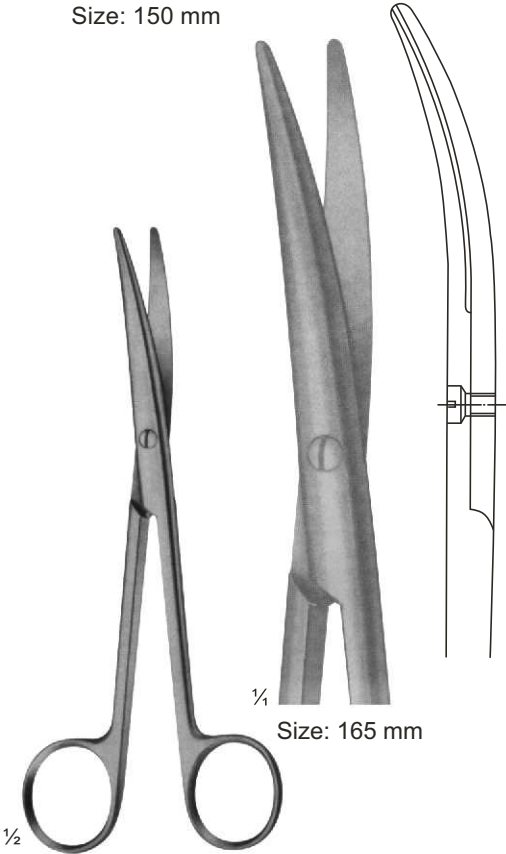

Size: 165 mm

03-262
Size: 165 mm

MAYO
03-264 - 266
Size: 165 mm

03-261
MAYO-LEXER
Standard

03-262 - 263
MAYO
03-262 (165 mm)
03-263 (200 mm)

03-265
Size: 200 mm
03-266
Size: 210 mm

Dissecting Scissors

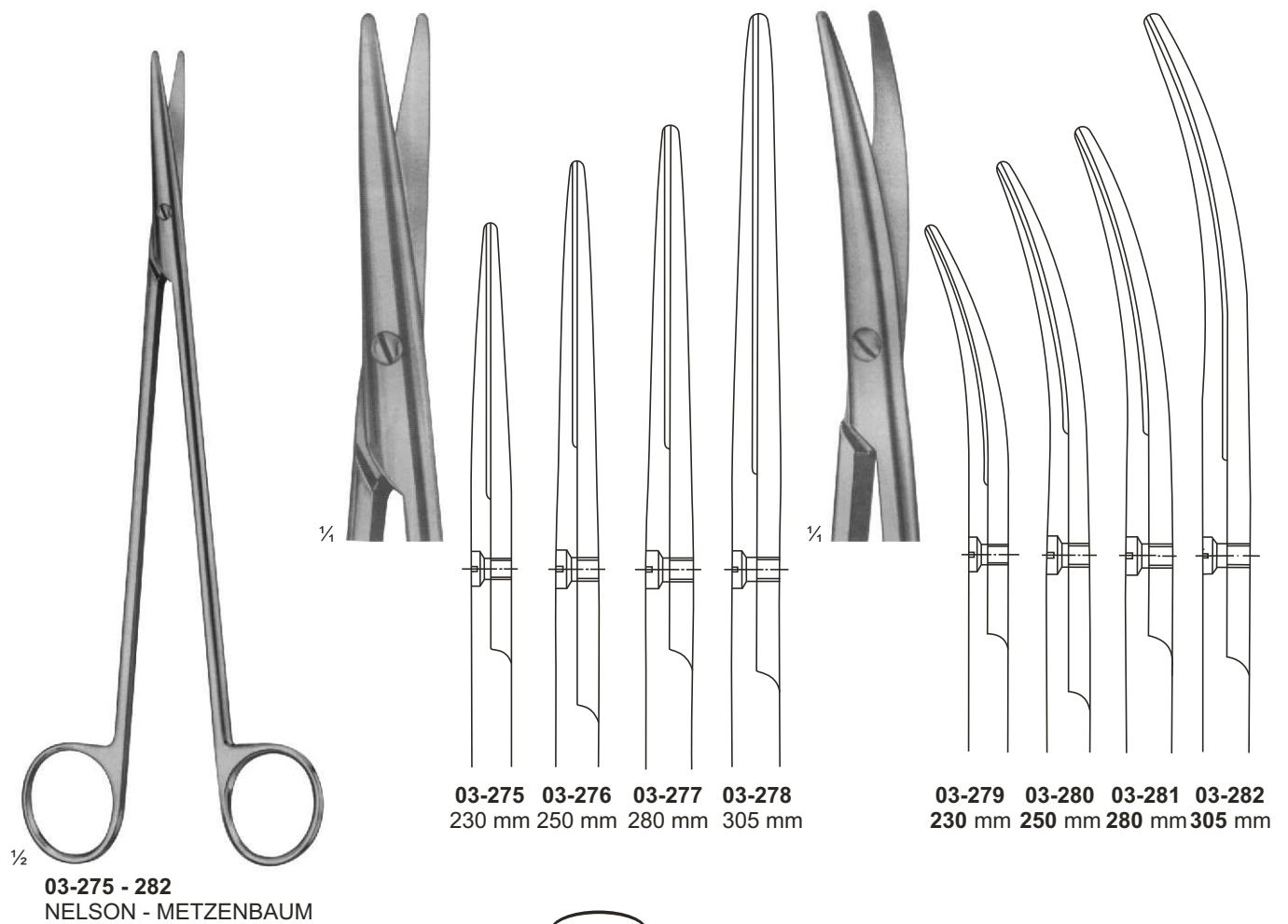
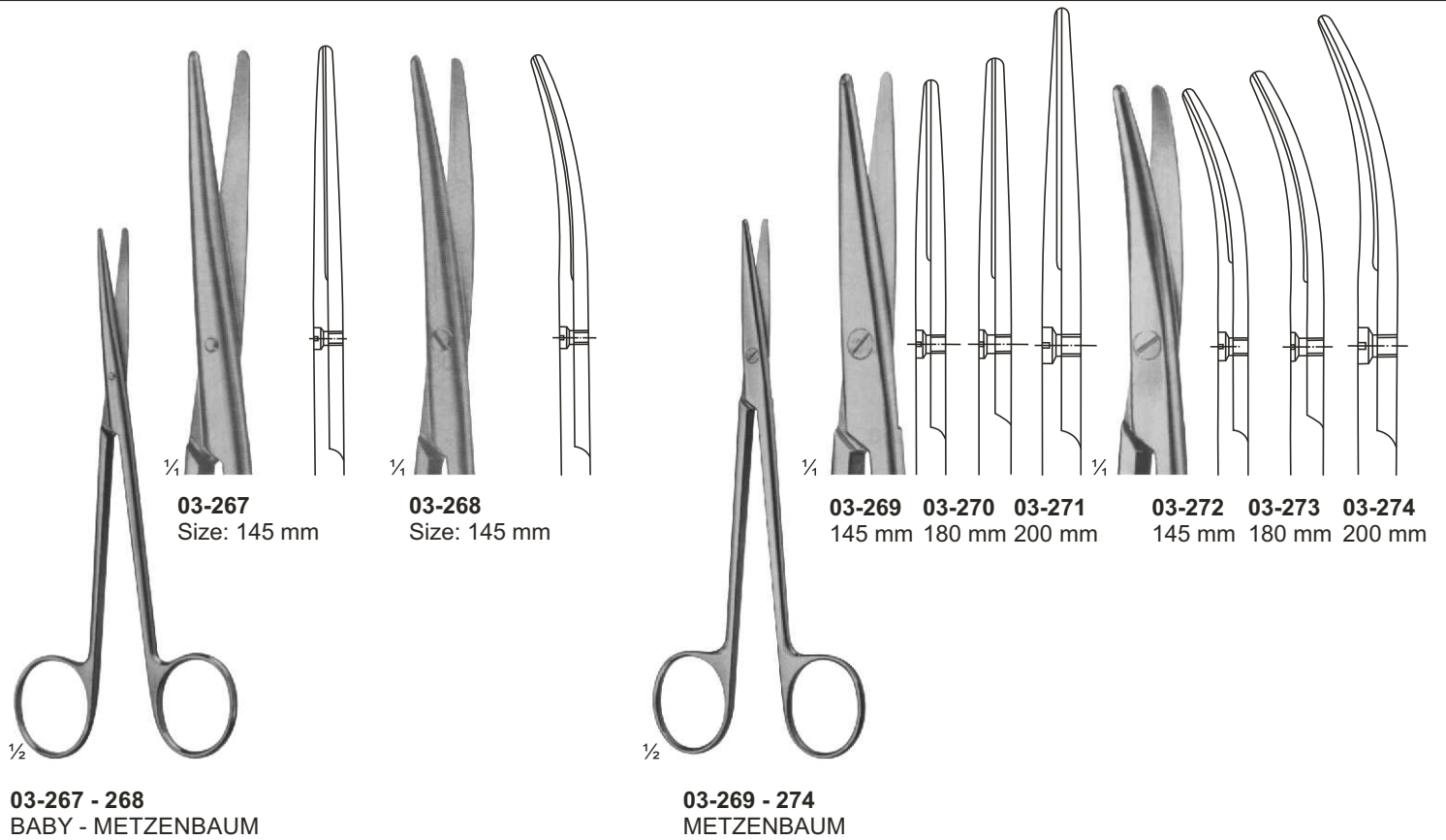

Vessel Scissors

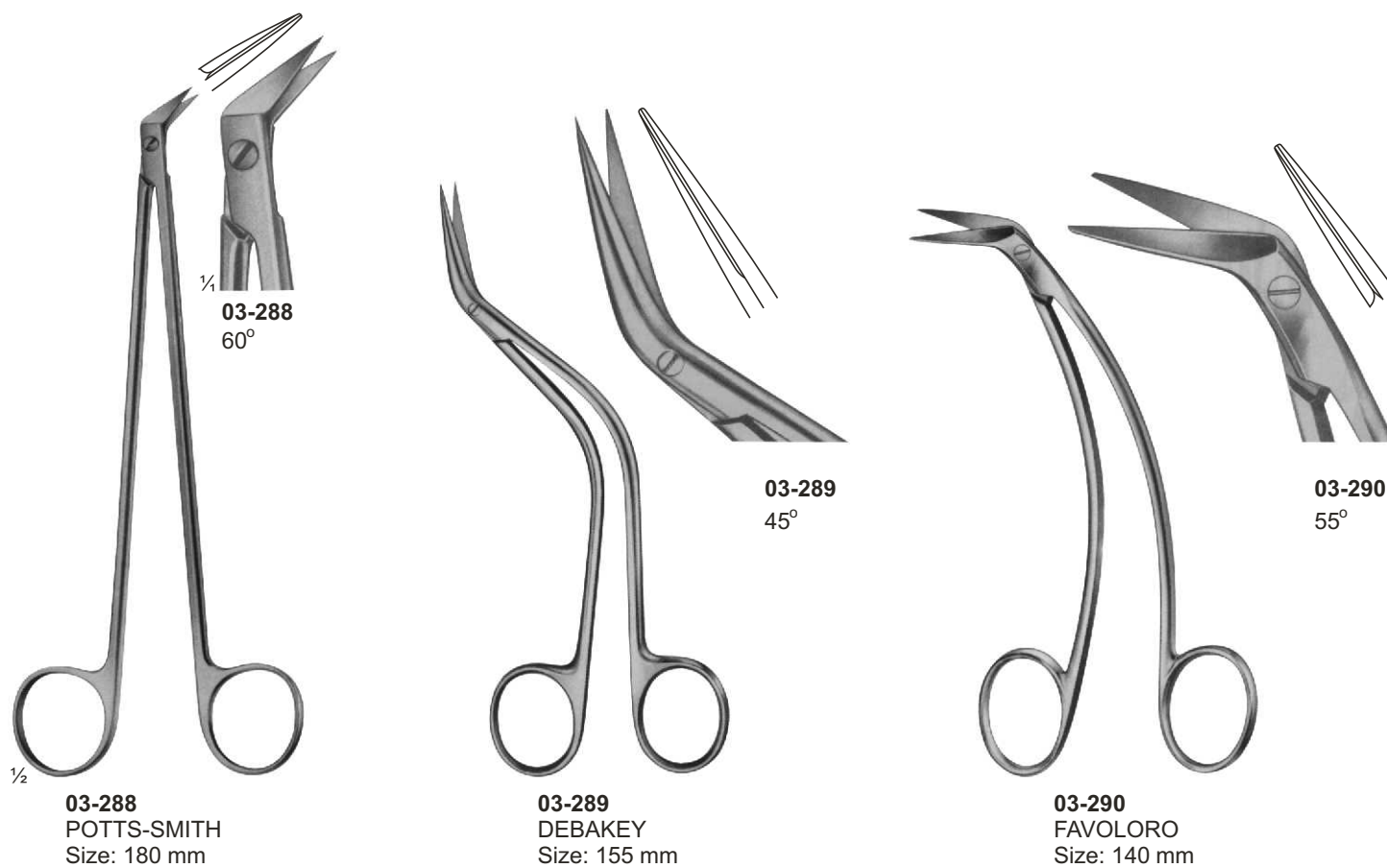
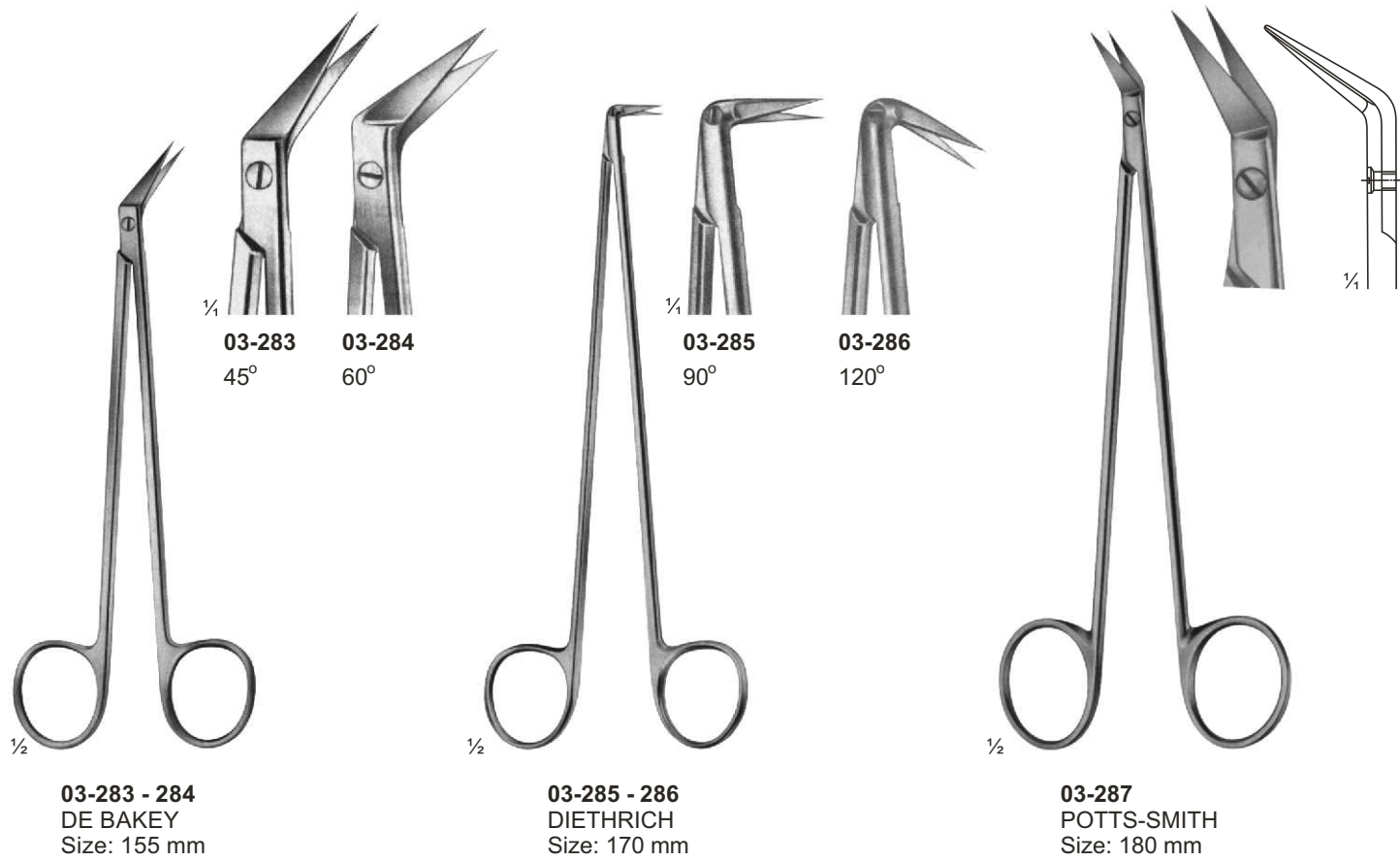

Cardiovascular and Neuro-Surgery Scissors

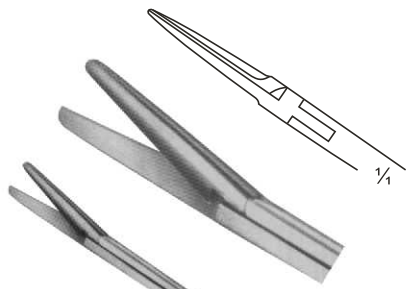

03-291
OLIVECRONA
Dura Scissors

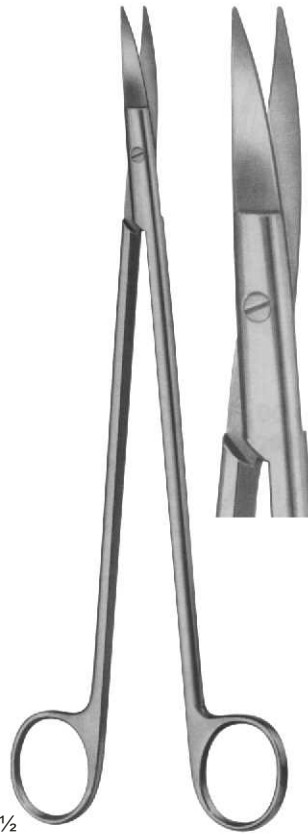

03-292
STRULLY
Pointed
Size: 220 mm

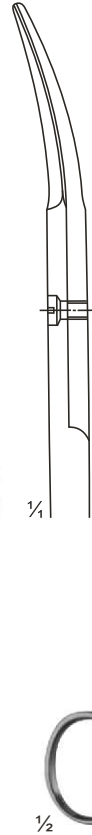

03-293
STRULLY
Probe Pointed
Size: 220 mm

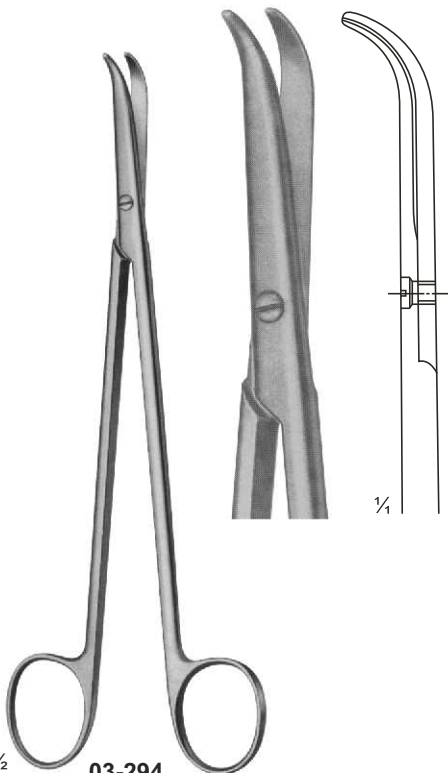
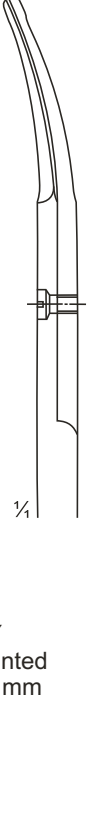

03-294
THOREK
Size: 180 mm

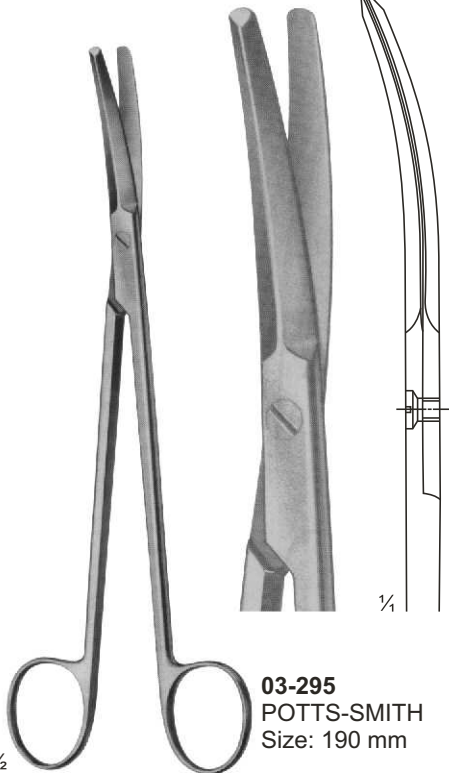

03-295
POTTS-SMITH
Size: 190 mm

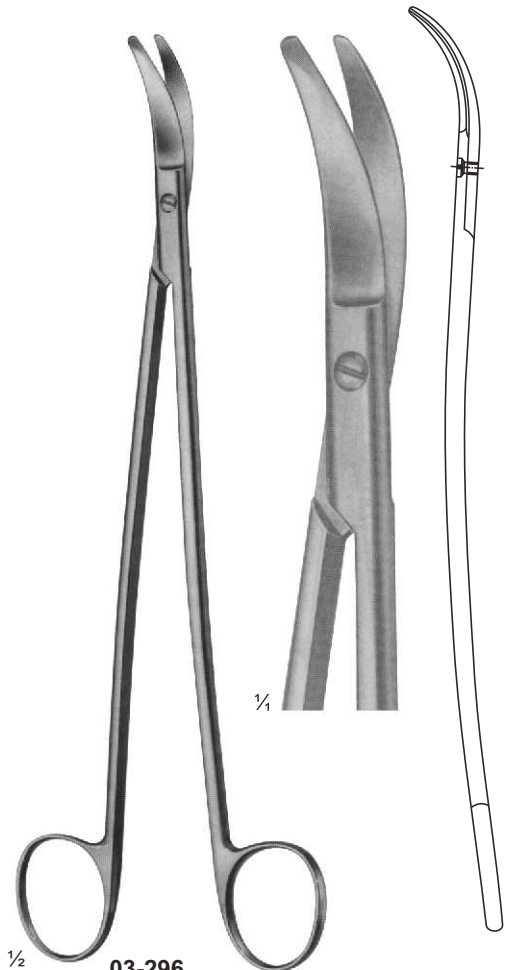

03-296
SATINSKY
Size: 245 mm

Delicate, Nasal and Tonsil Scissors



03-297
1 Finally Toothed Blade
Size: 130 mm

03-298
LOCKLIN
Curved Sideways,
1 Toothed Blade
Size: 155 mm

03-299
FOMON
Blades Serrated
Size: 145 mm

03-300
COTTLE
Size: 165 mm

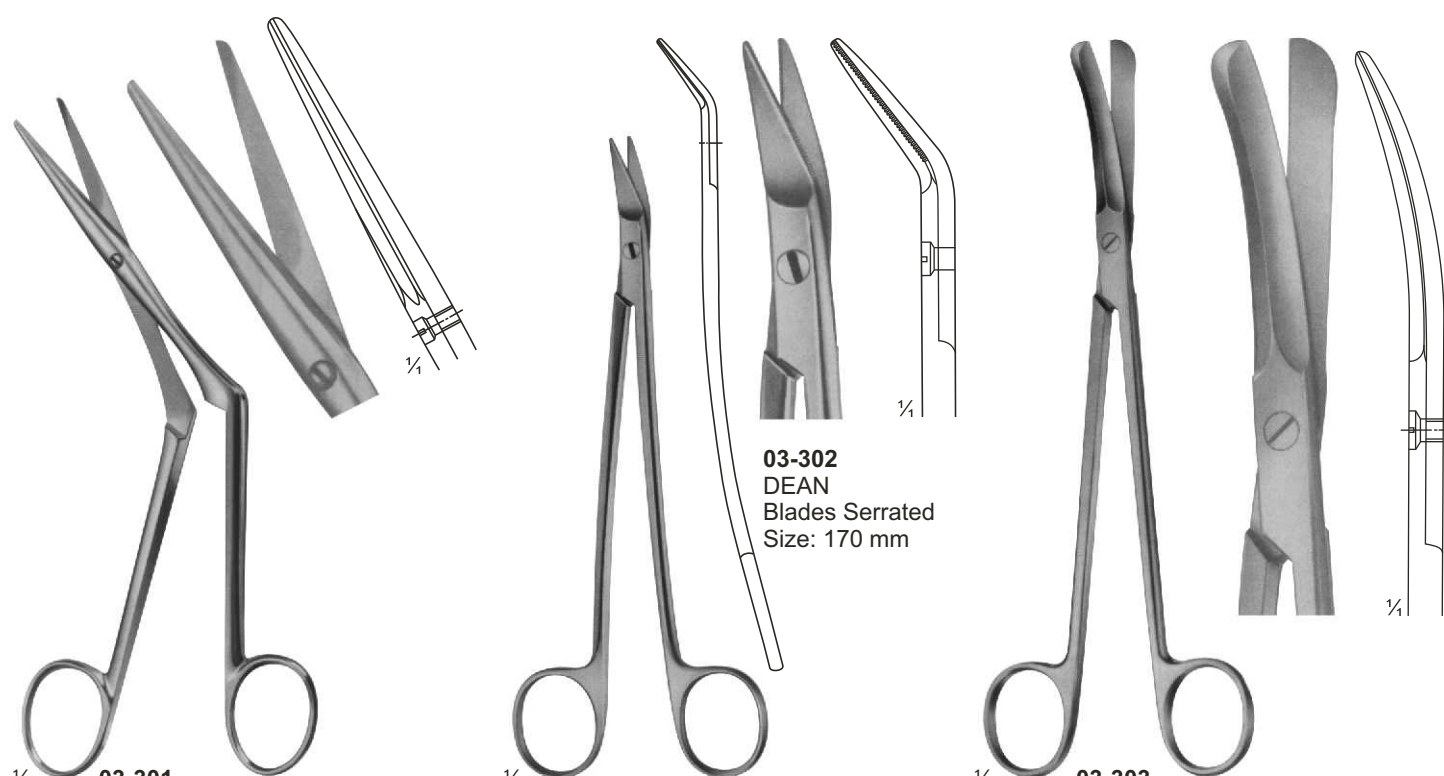

03-301
HEYMANN-KNIGHT
Size: 175 mm

03-302
DEAN
Blades Serrated
Size: 170 mm

03-303
GOOD
Size: 195 mm

Bone Shears

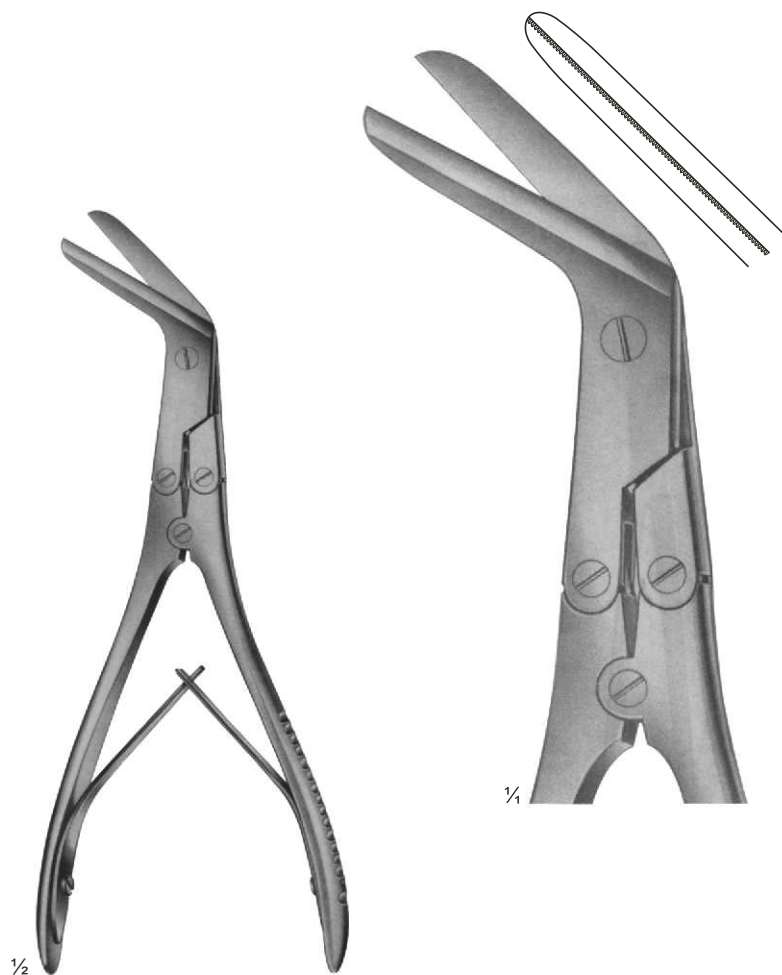

03-304
KILLIAN
Size: 200 mm



03-305 - 306

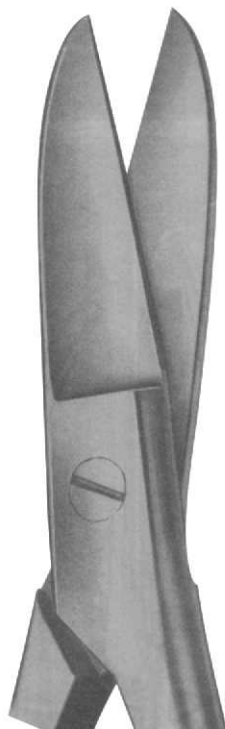

03-305
195 mm

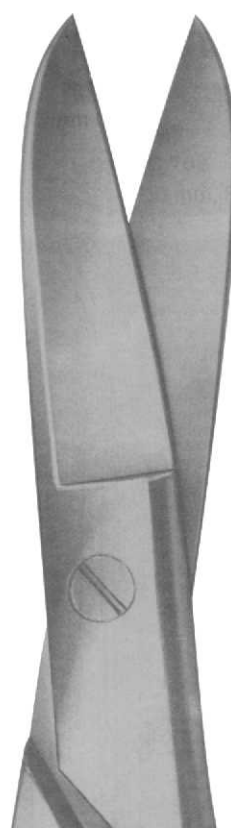
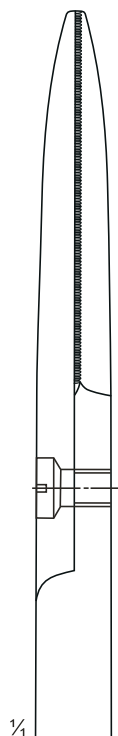

03-306
225 mm

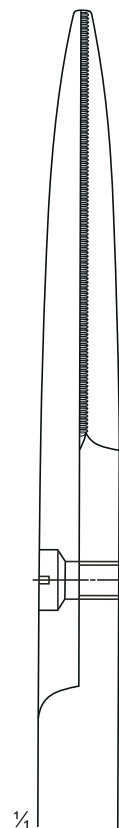

Operating and Gynaecology Scissors

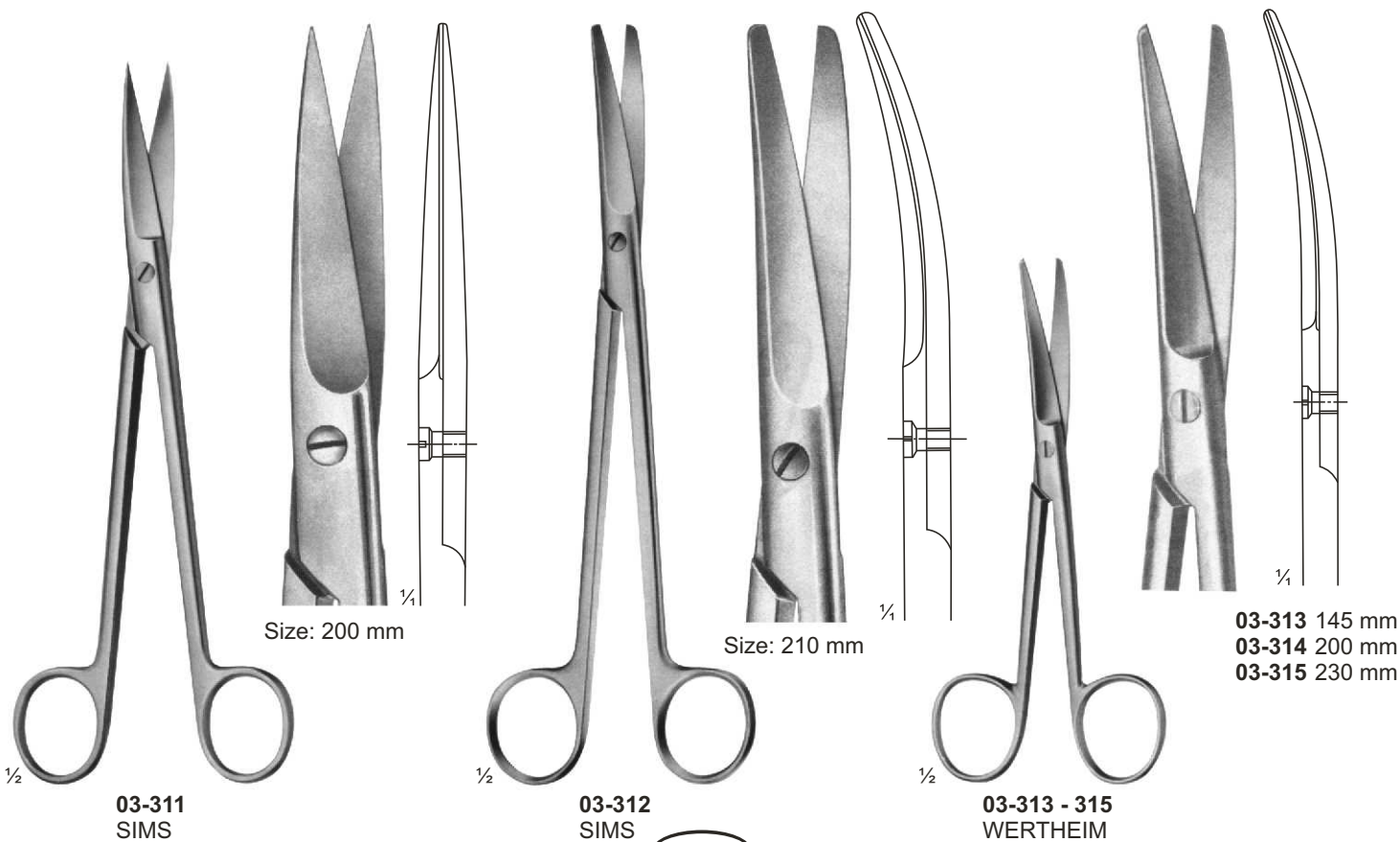
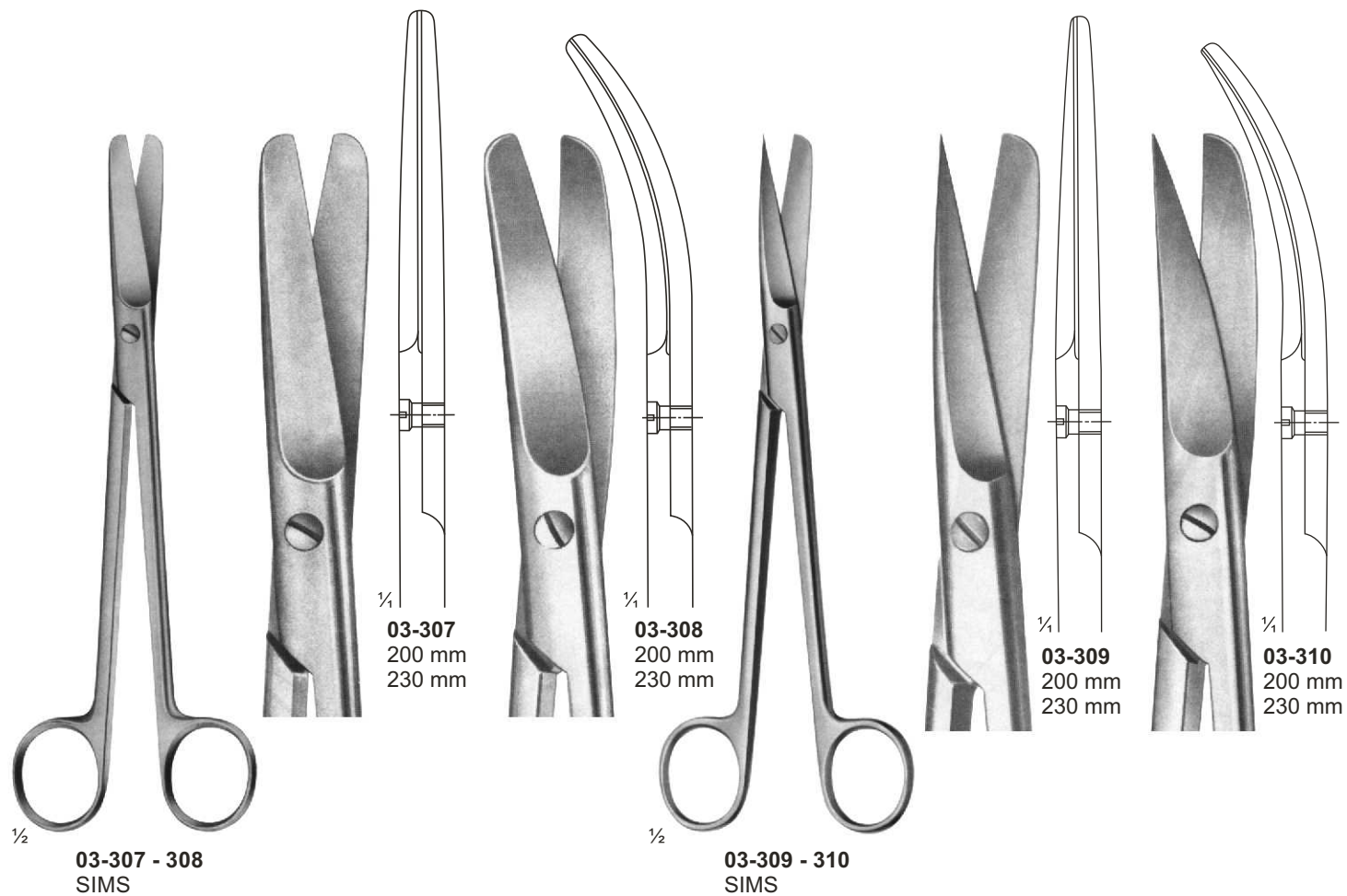

Operating and Gynaecology Scissors

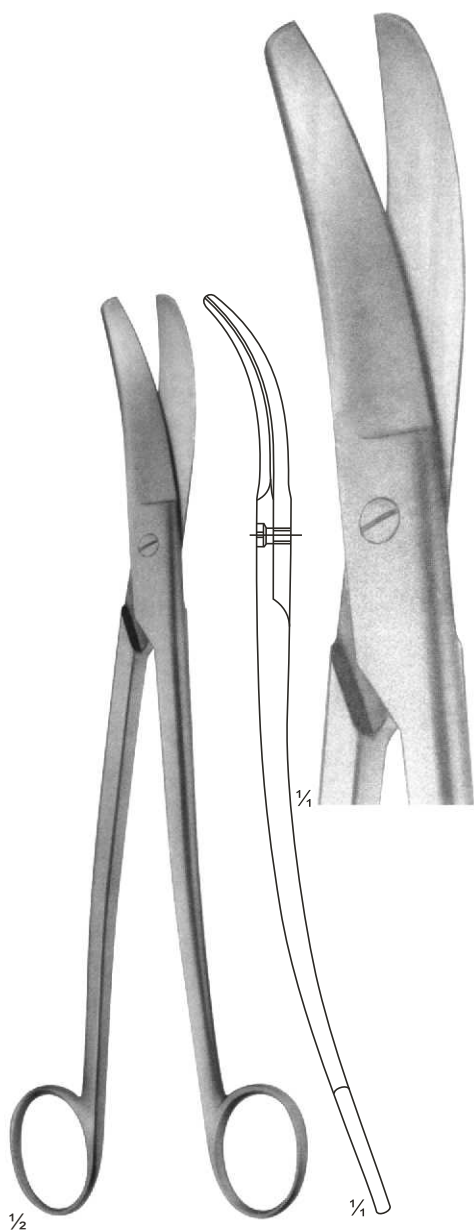

03-316
SIEBOLD
 Uterine Scissors
 Size: 245 mm

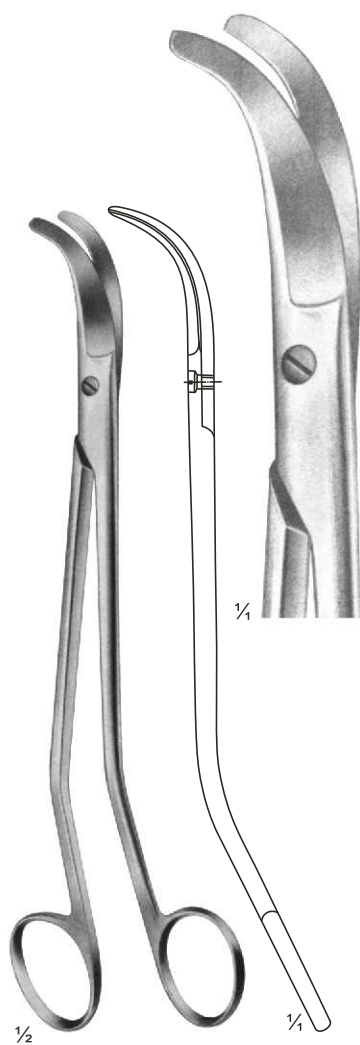

03-317
BOZEMANN
 Uterine Scissors
 Size: 220 mm

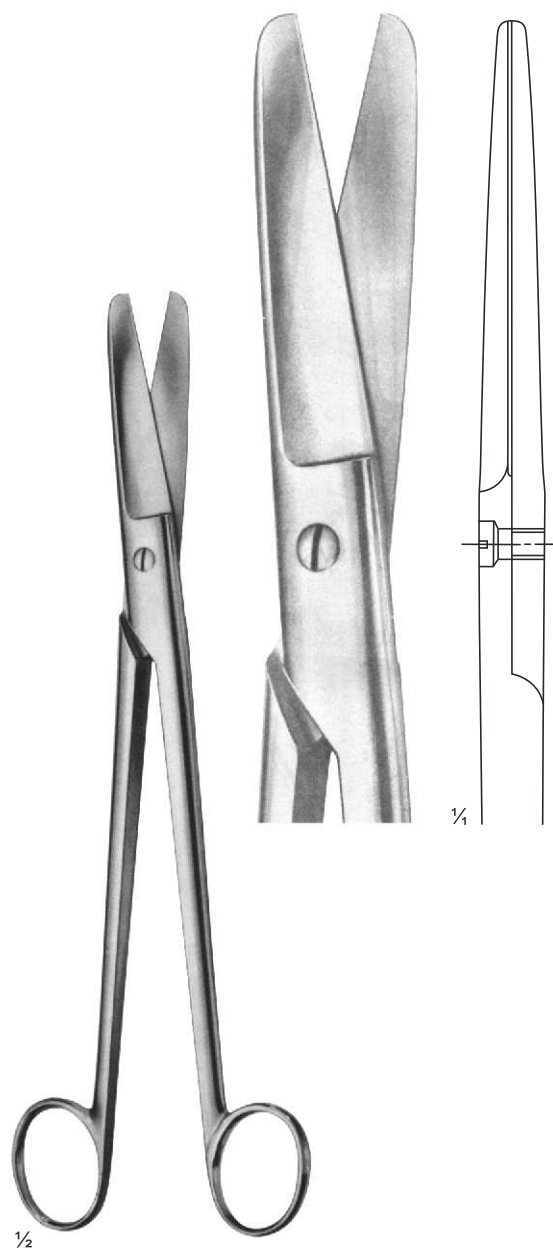

03-318
SIMS-SIEBOLD
 Uterine Scissors
 Size: 250 mm

Operating and Gynaecology Scissors

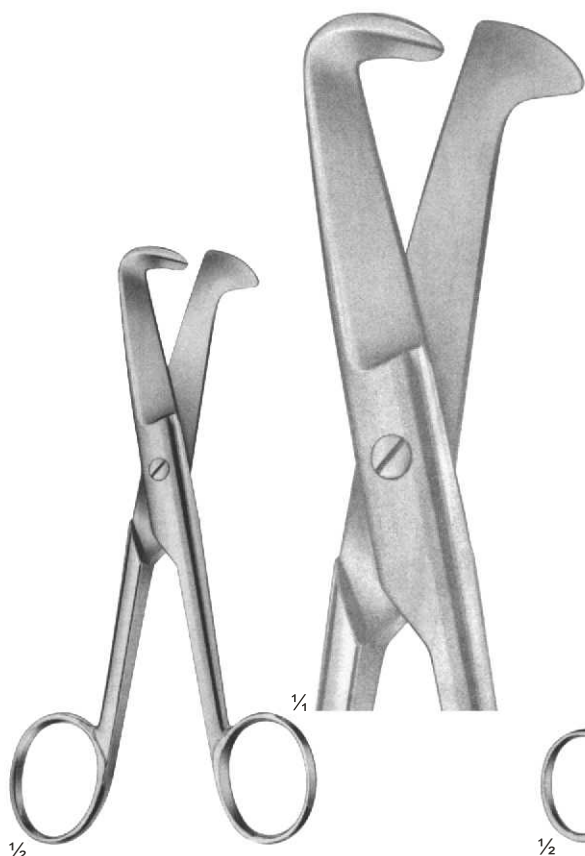

03-319
SCHUMACHER
 Umbilical Cord Scissors
 Size: 155 mm

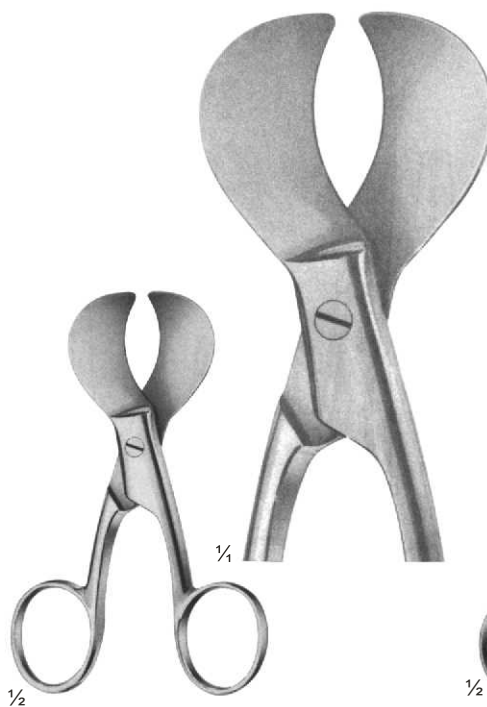

03-320
 Umbilical Cord Scissors
 Size: 105 mm

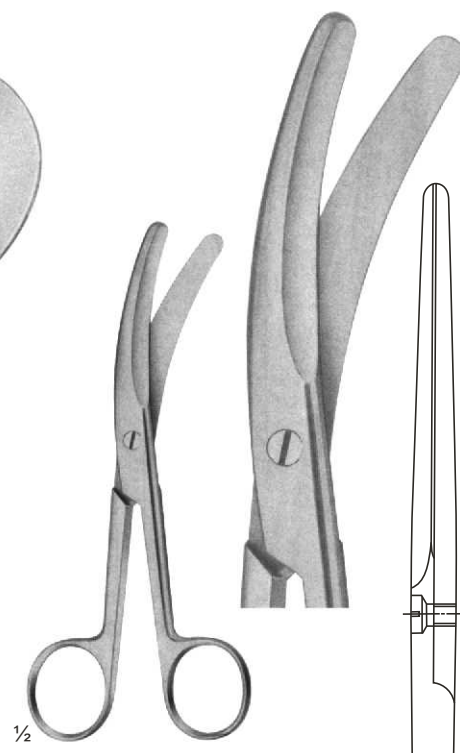

03-321
 Umbilical Cord Scissors

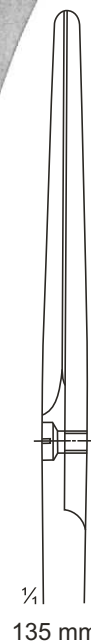

1/1
 135 mm

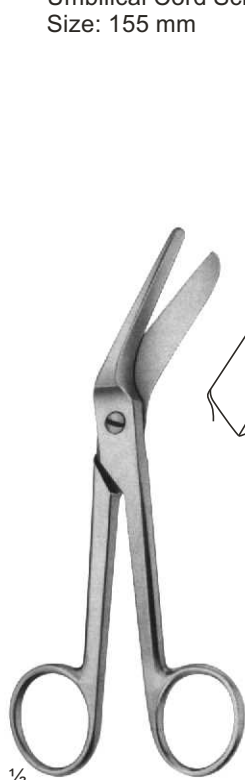

03-322 - 323
BRAUN-STADLER
 Empisiotomy Scissors

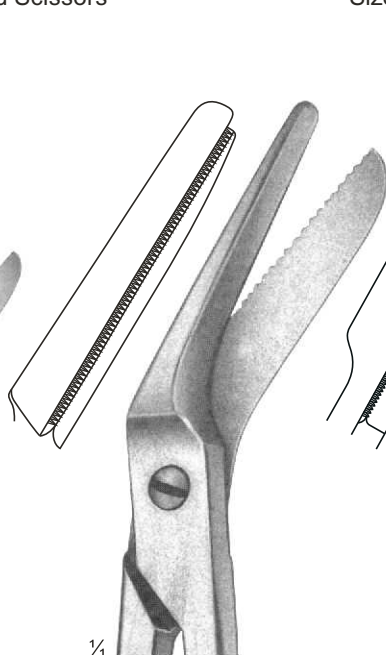

03-322
 145 mm

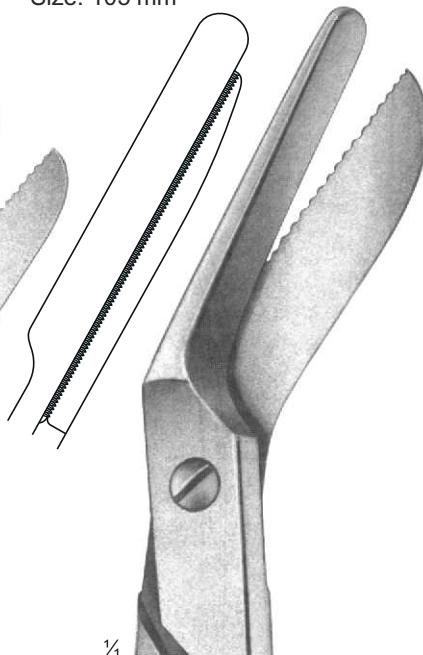

03-323
 200 mm

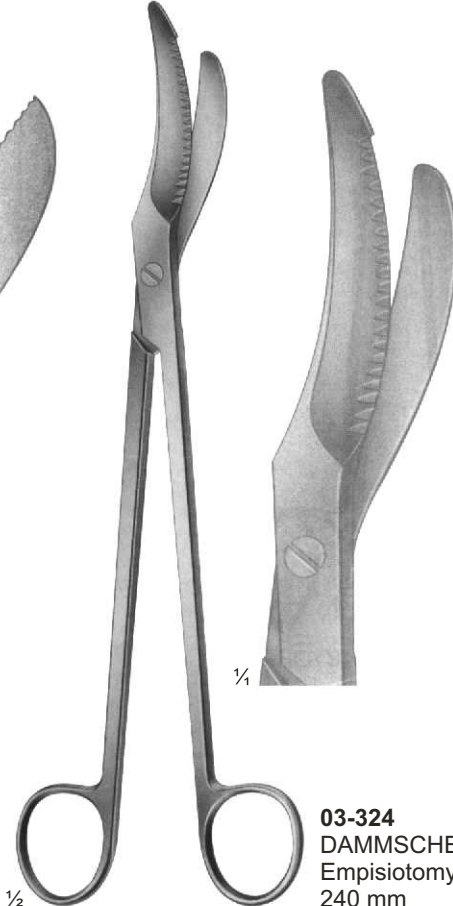

03-324
DAMMSCHERE
 Empisiotomy Scissors
 240 mm

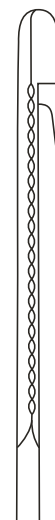

Bowel Scissors, Cartilage Scissors

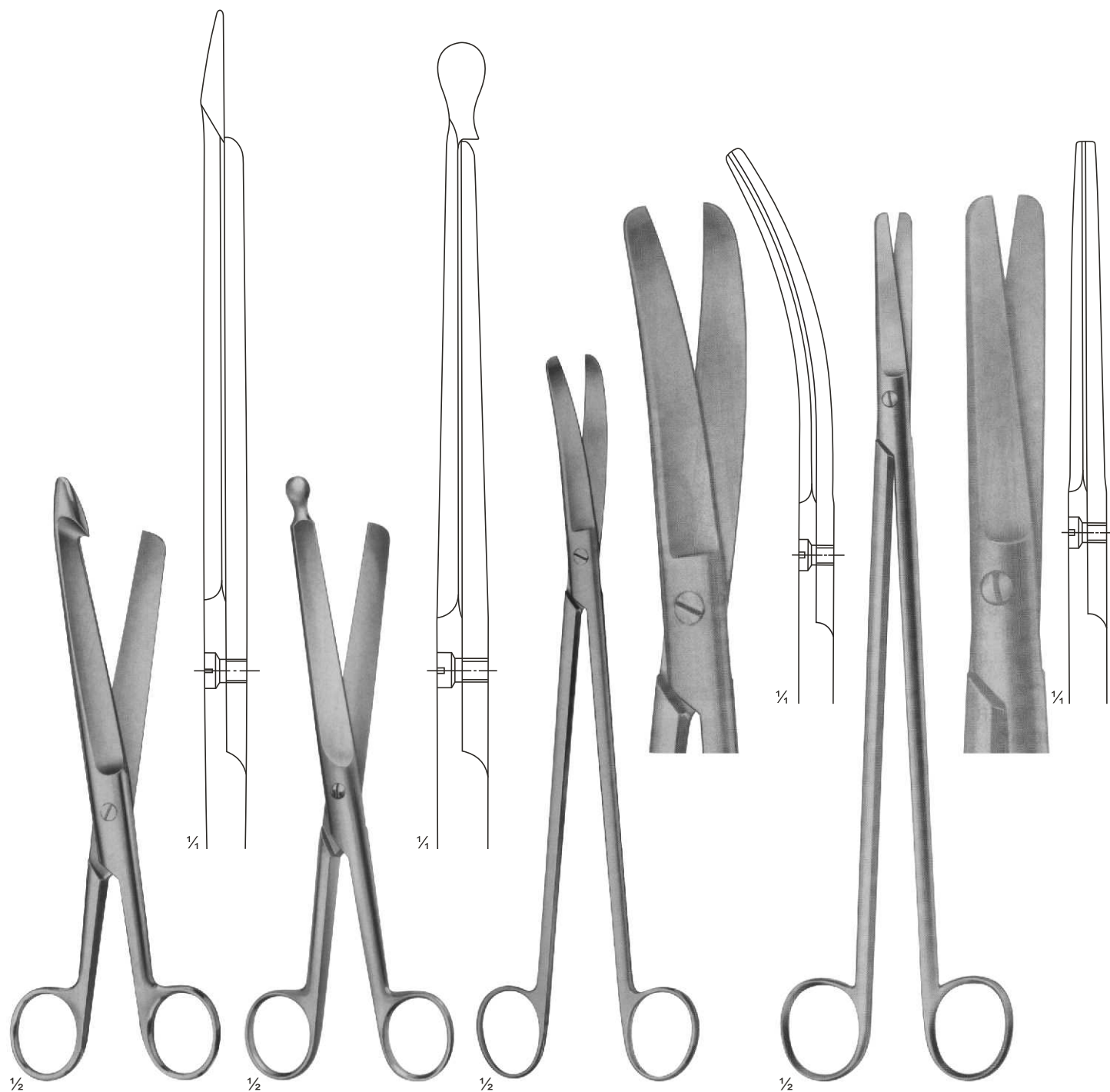

03-325
DAMMSCHERE
Bowel Scissors
Size: 210 mm

03-326
DAMMSCHERE
Bowel Scissors
Size: 210 mm

03-327
LLOYD-DAVIES
(GOLIGHER'S)
Rectal Scissors
Size: 255 mm

03-328
STELZNER
Rectal Scissors
Size: 310 mm

Ligature Scissors

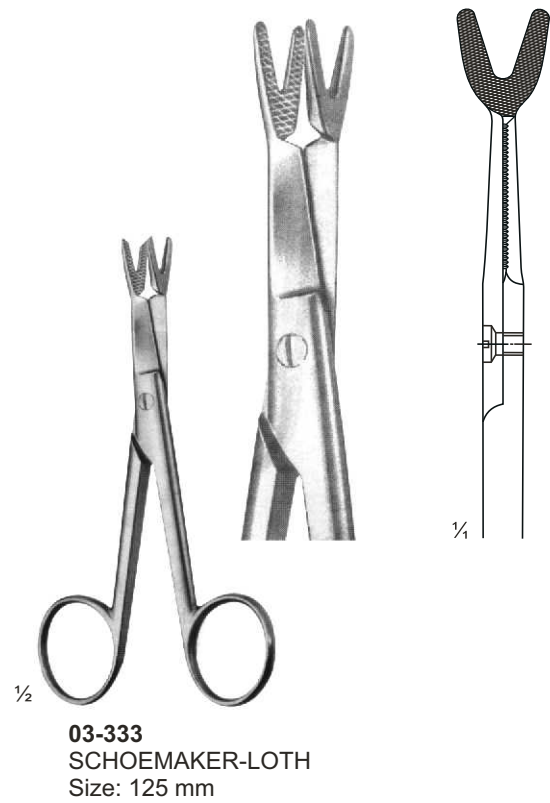
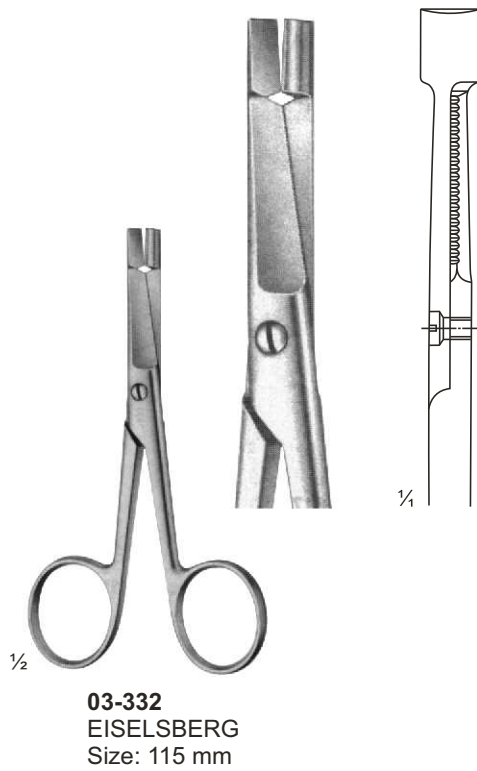
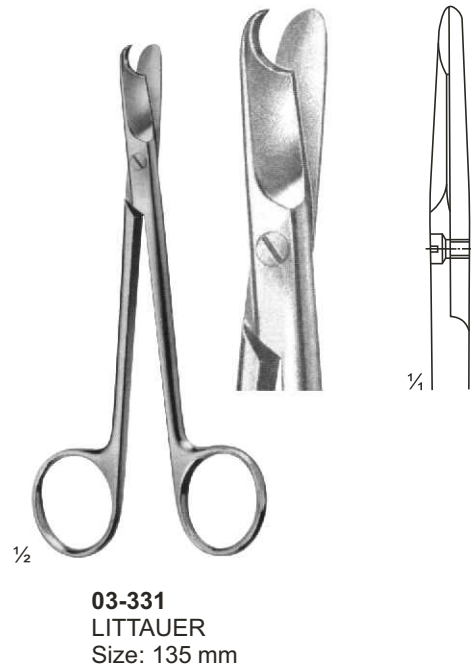
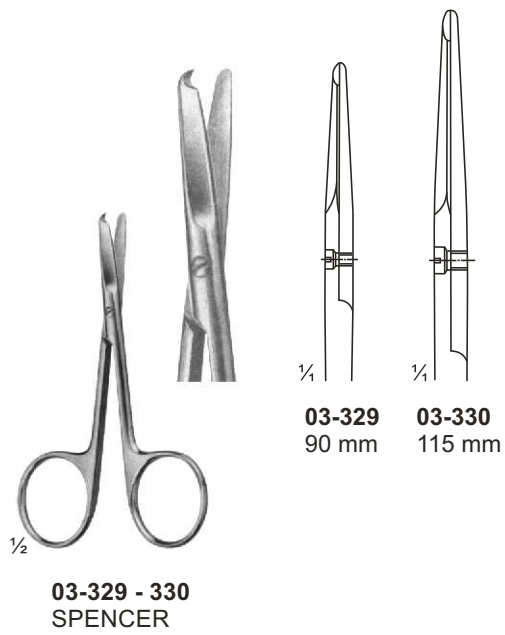

Wire and Plate Scissors



1/2

03-334 - 338
BEEBE
Size: 110 mm

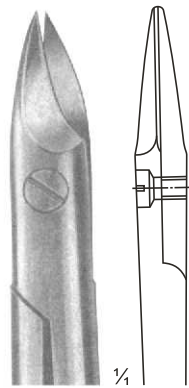

1/4

03-334

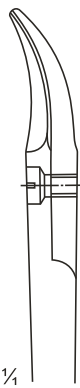

1/4

03-335

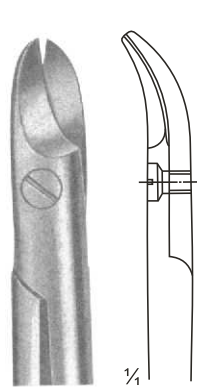

1/4

03-336
Broad Blades

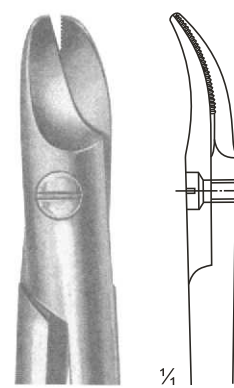

1/4

03-337
1 Blade Serrated

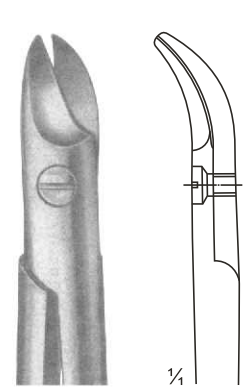

1/4

03-338
NAUJOKS
Strongly Curved

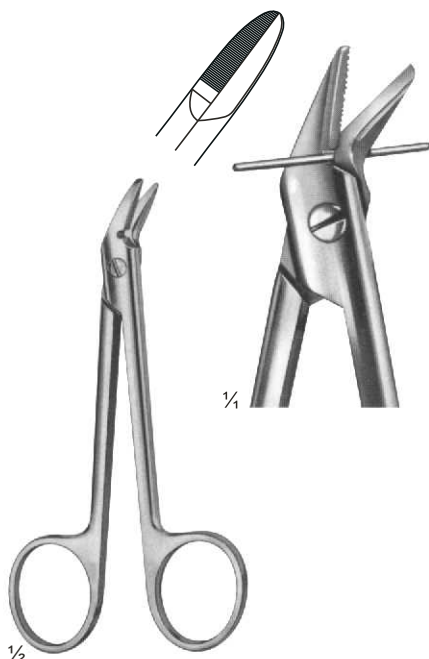

1/2

03-339
1 Blade Serrated
Size: 120 mm

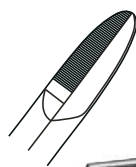

1/4



1/2

03-340
STRACK
Size: 100 mm

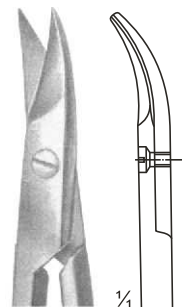

1/4



1/2

03-341
HARVEY
Size: 125 mm

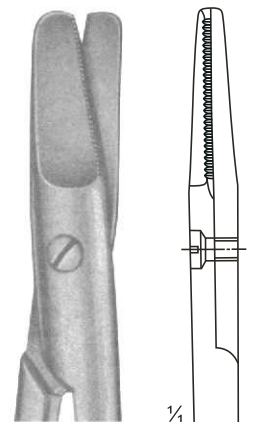

1/4

Wire and Plate Scissors

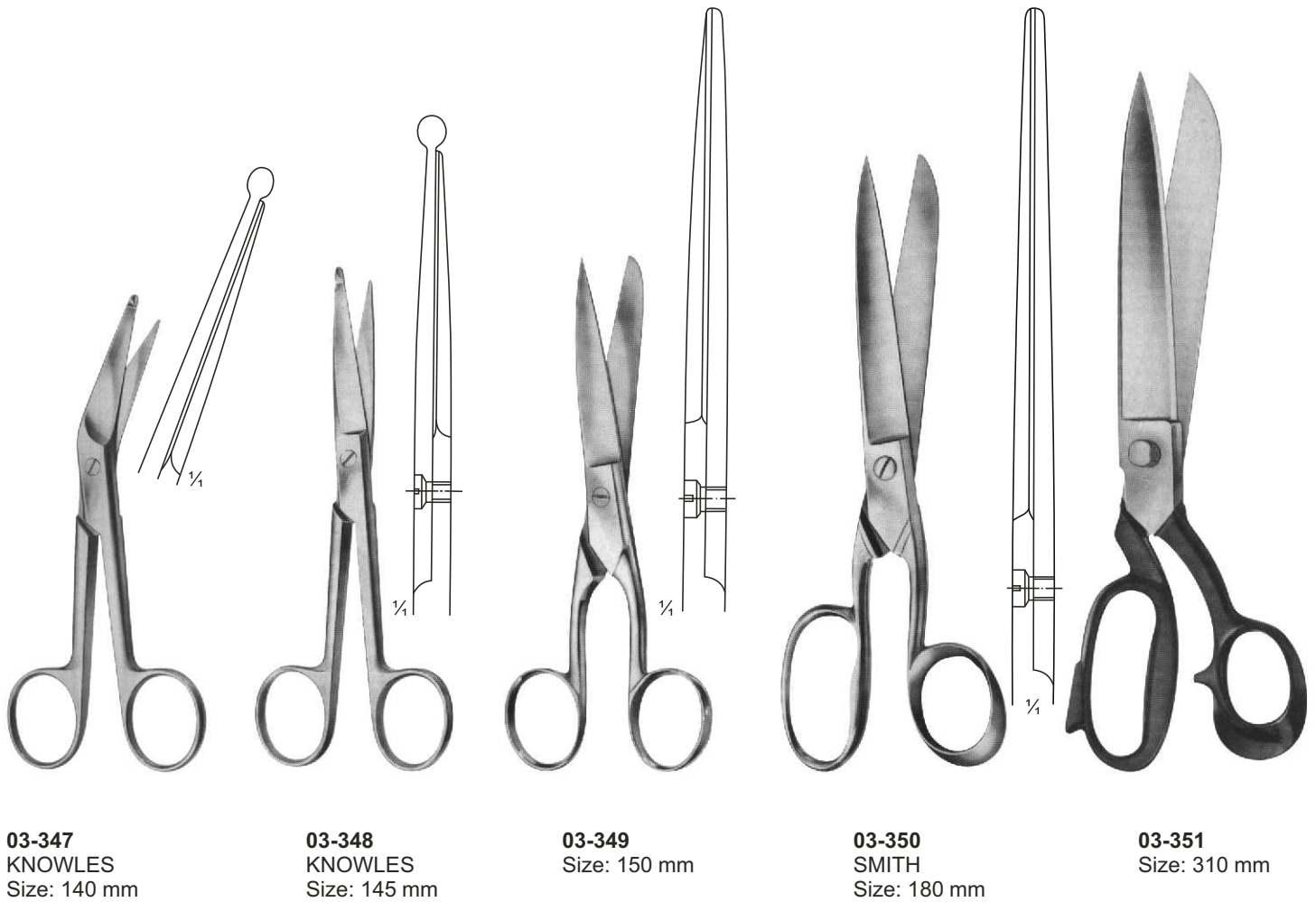
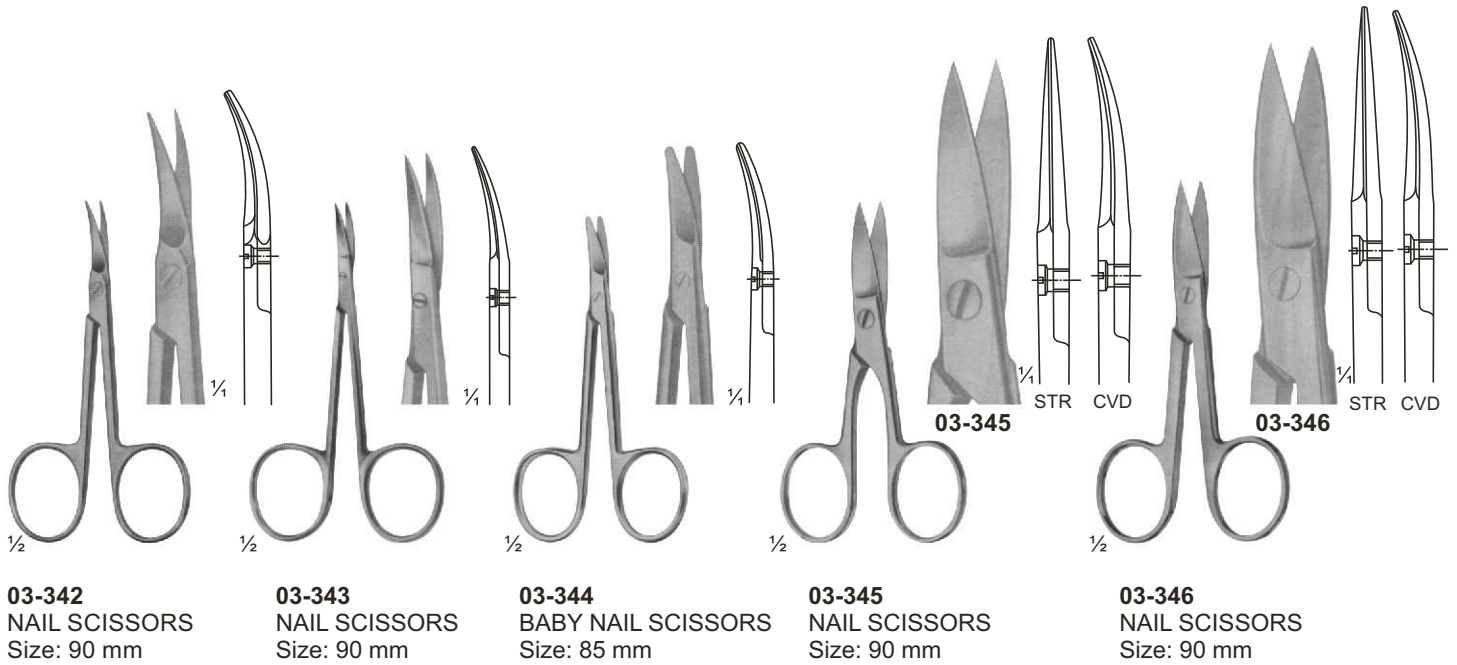

Bandage and Cloth Scissors



03-352
UNIVERSAL AND BANDAGE SCISSORS
180 mm

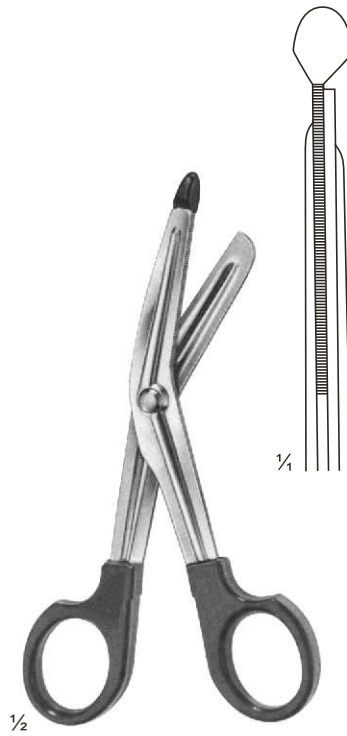

03-353
LISTER
Size: 145 mm

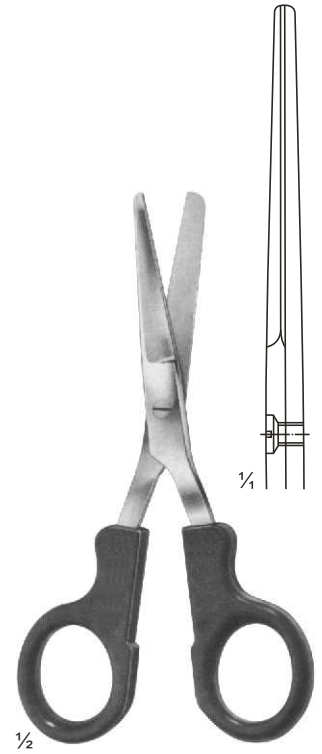

03-354
LISTER
Size: 145 mm

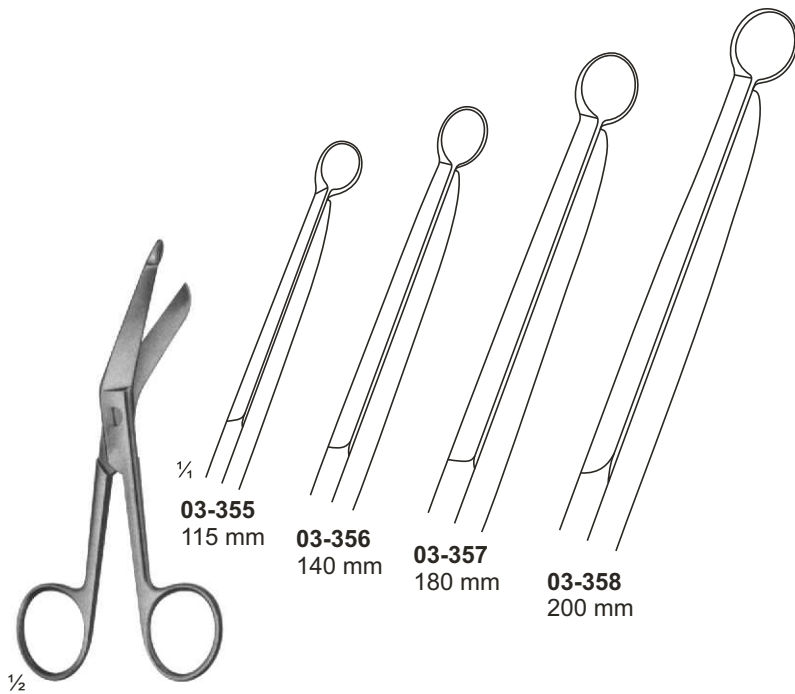

03-355 - 358
LISTER

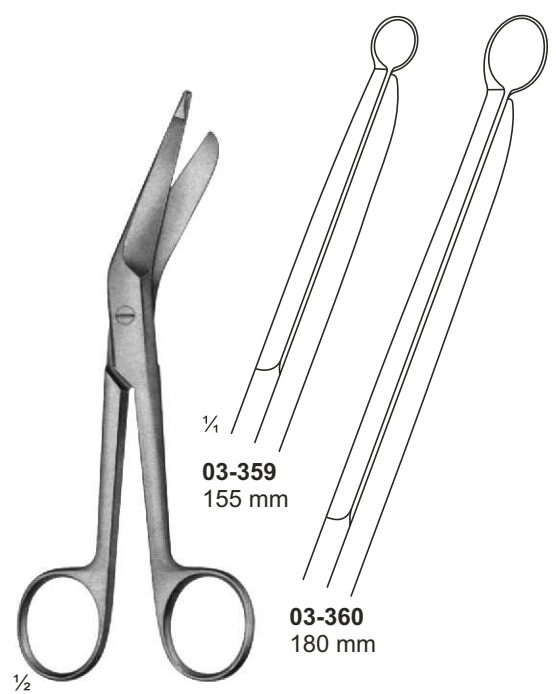

03-359 - 360
LISTER

Bandage, Cloth and Plaster Scissors

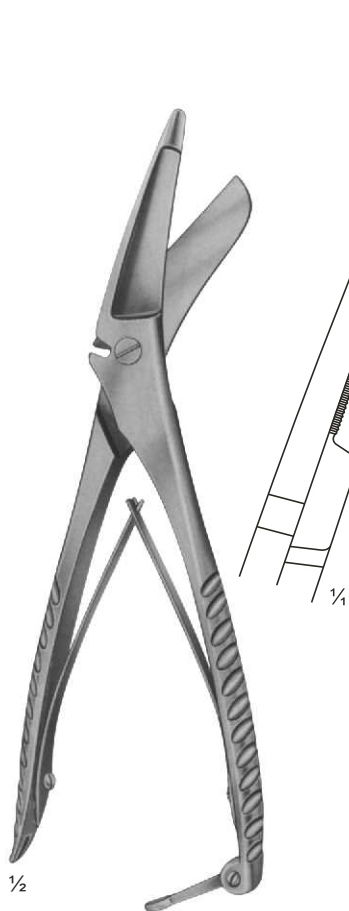

03-361
CLOTH SCISSORS
205 mm

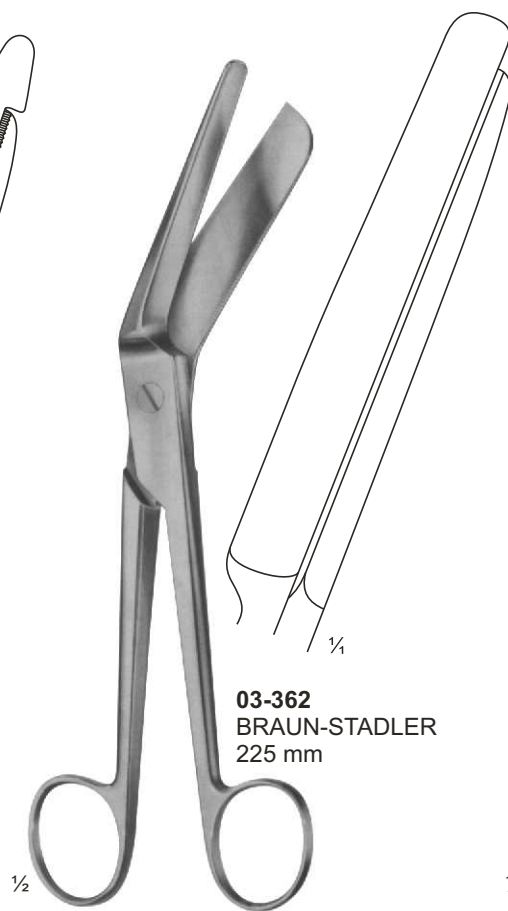

03-362
BRAUN-STADLER
225 mm

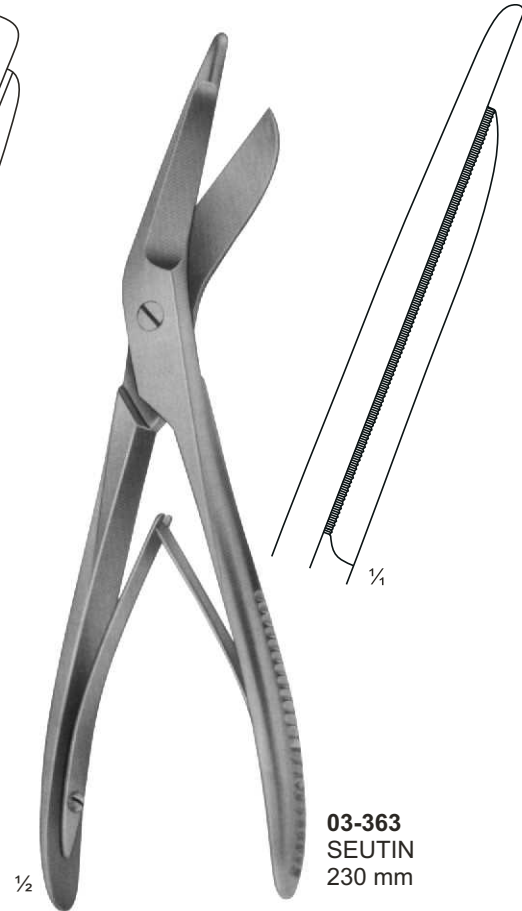

03-363
SEUTIN
230 mm

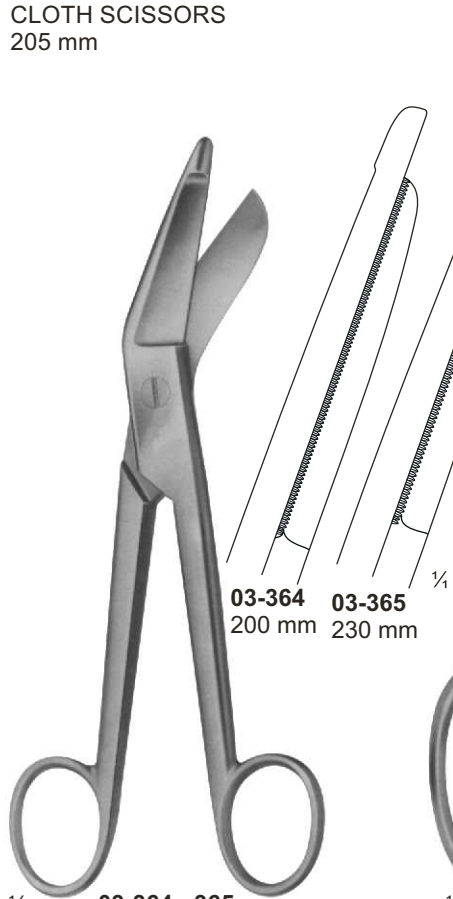

03-364 - 365
ESMARCH

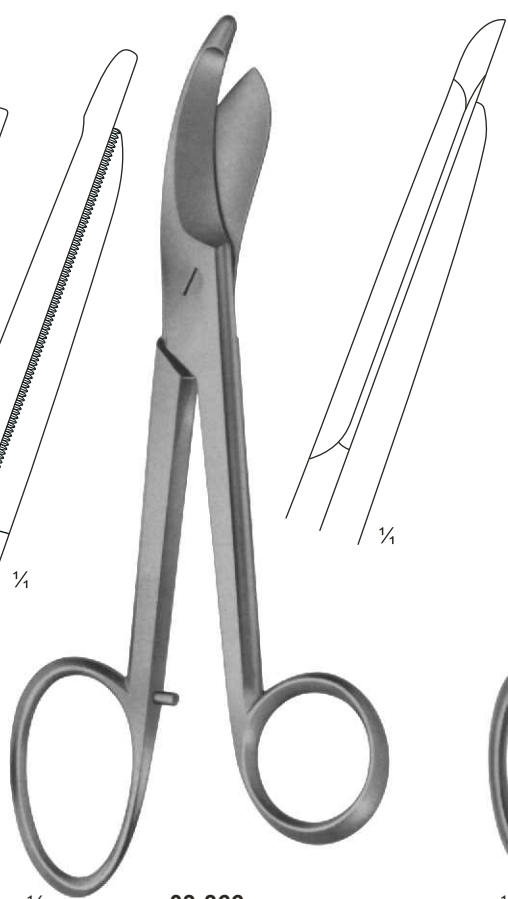

03-366
BRUNS
235 mm

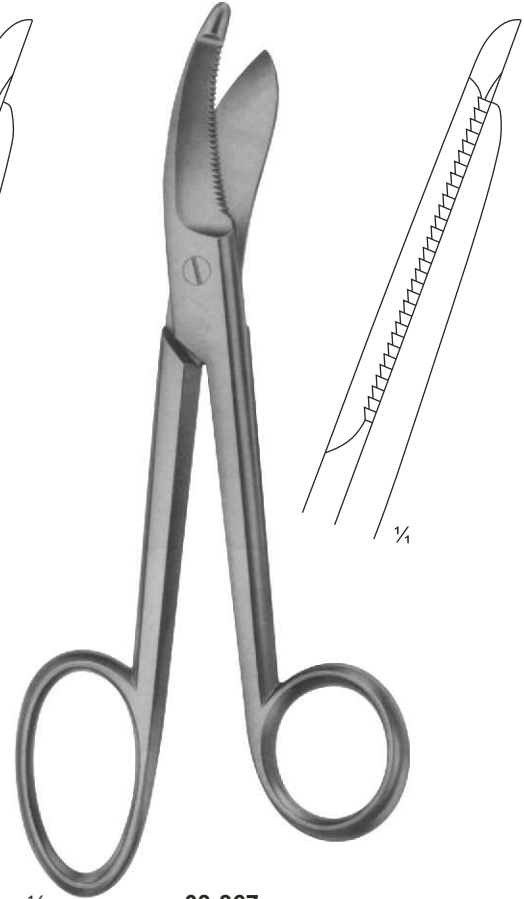

03-367
BRUNS
235 mm

Micro Forceps, Jeweler Types

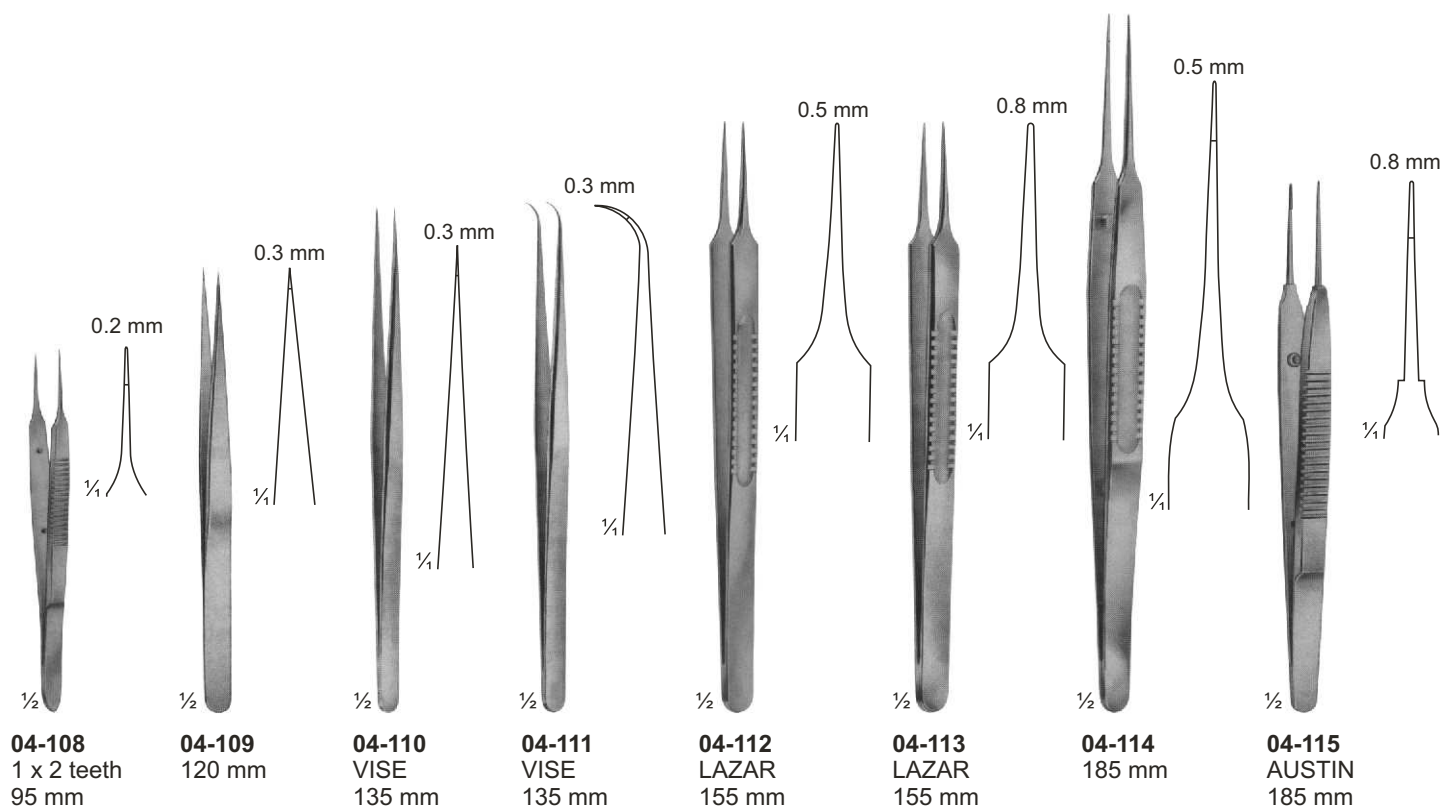
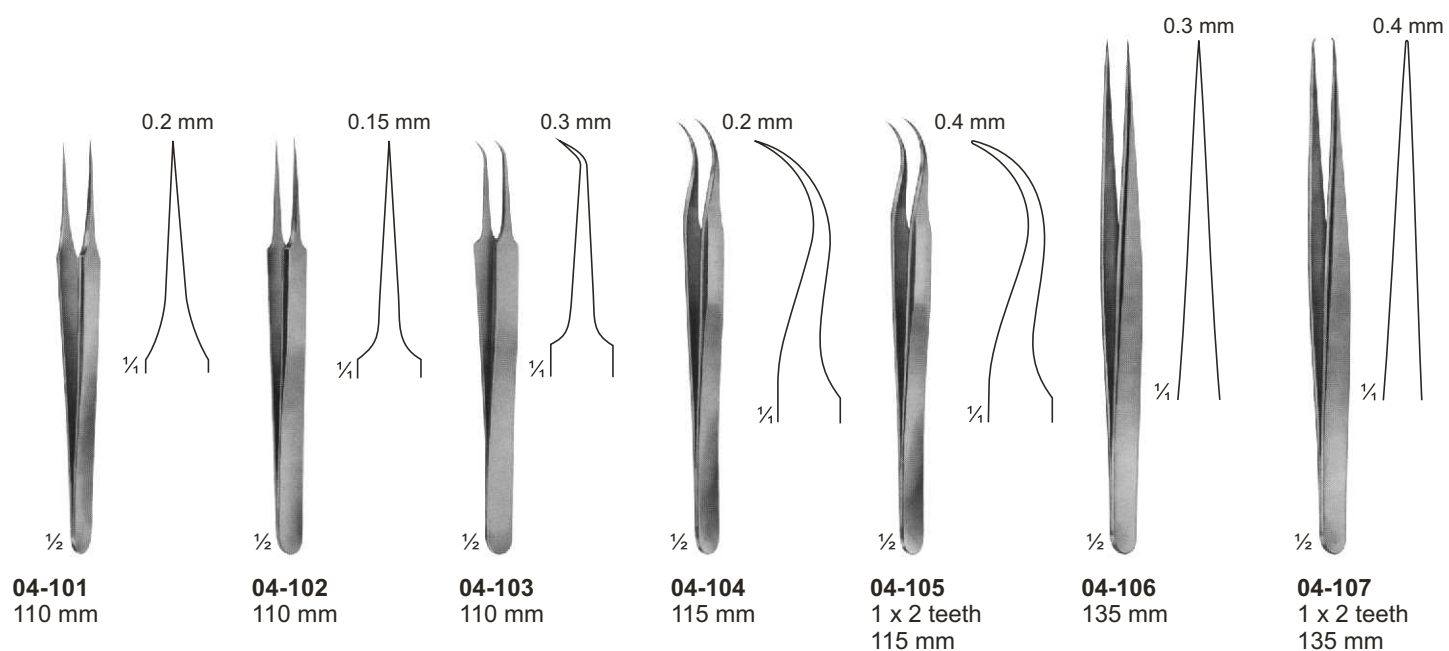

Ligature Forceps, Micro Forceps (Light Patterns)

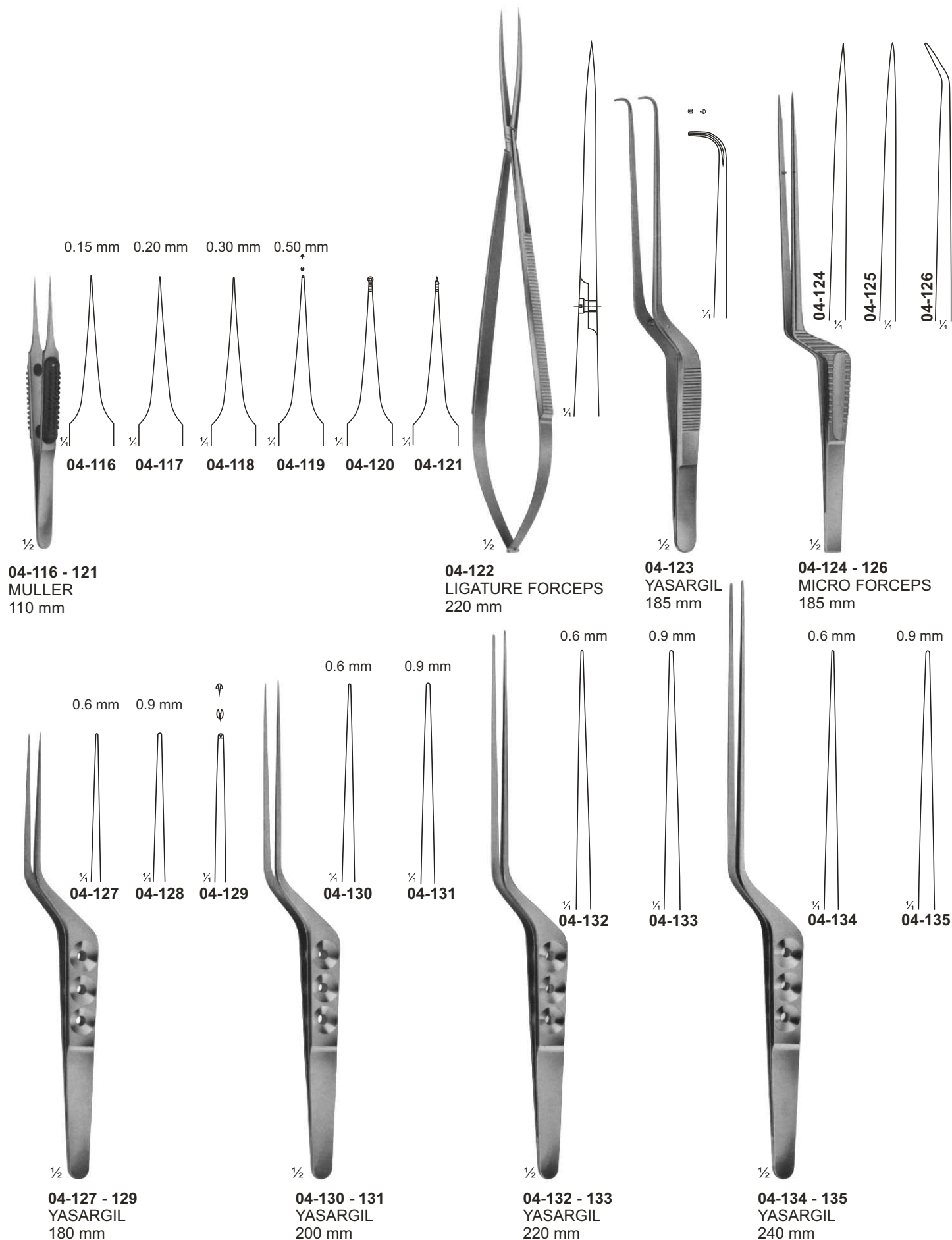

Forceps for Grasping Tissue, Tumors

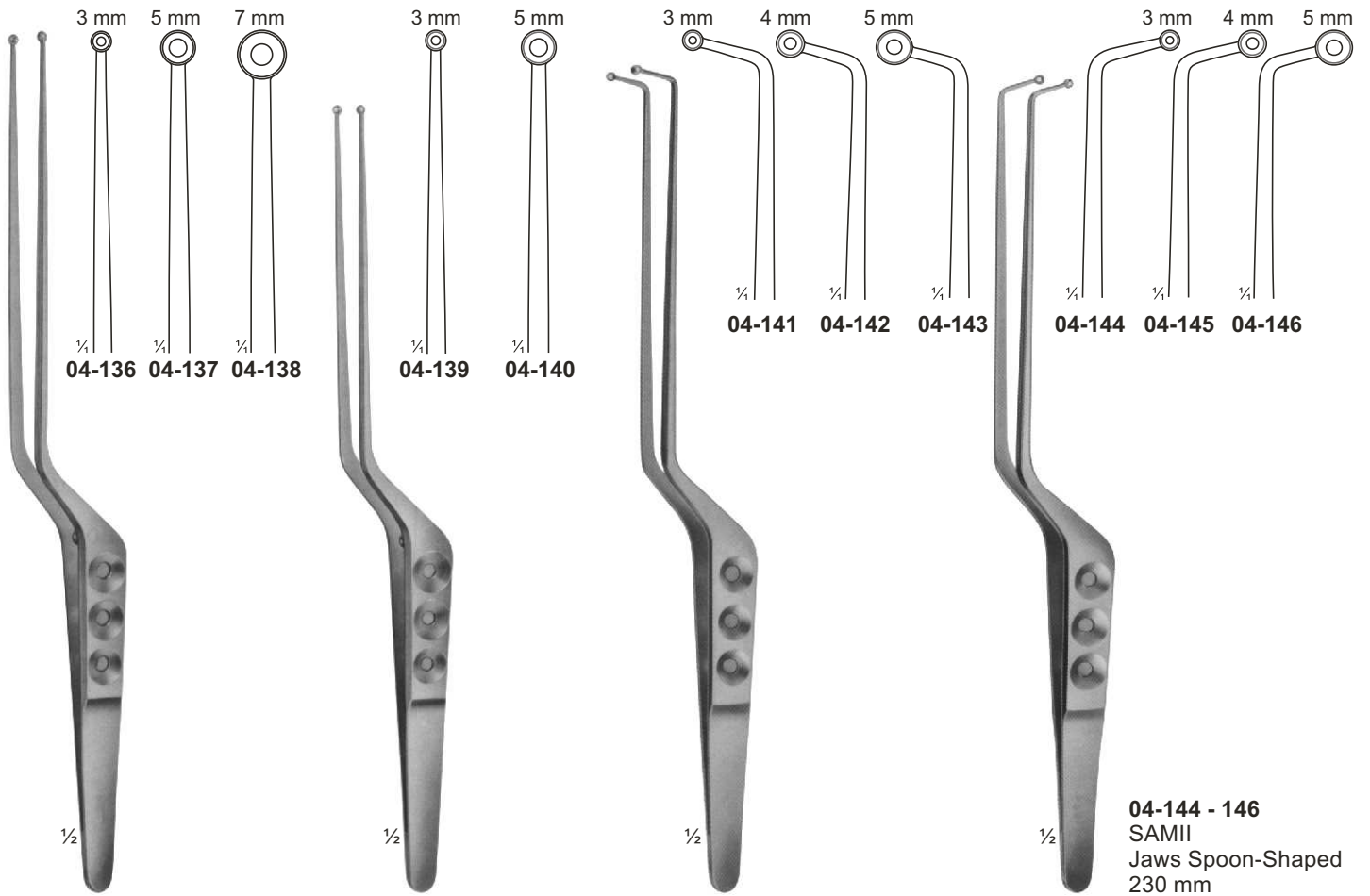

04-136 - 138
YASARGIL-SAMI
Jaws Spoon-Shaped
240 mm

04-139 - 140
YASARGIL
Jaws Spoon-Shaped
220 mm

04-141 - 143
SAMII
Jaws Spoon-Shaped
230 mm

04-144 - 146
SAMII
Jaws Spoon-Shaped
230 mm

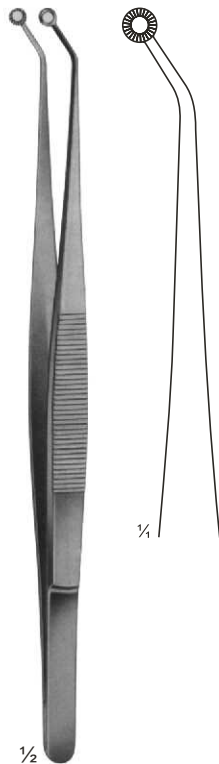

04-147
HUNT
Tumor-and Vessel Forceps
200 mm

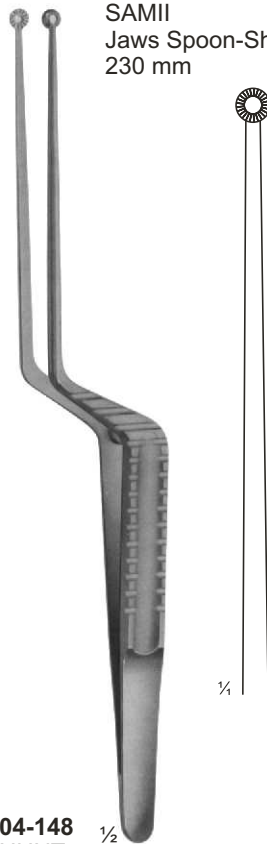

04-148
HUNT
Tumor-and Vessel Forceps
200 mm

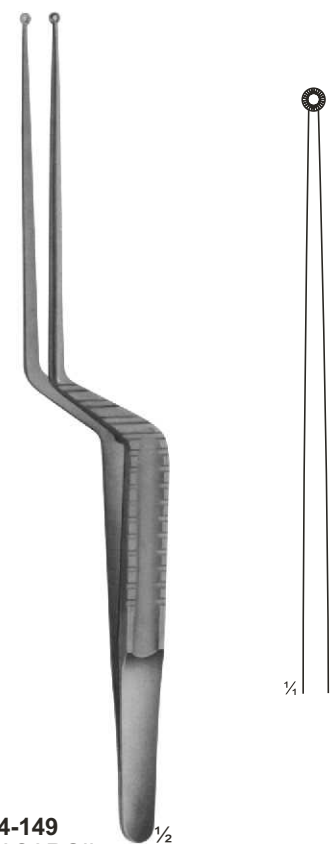

04-149
YASARGIL
Tumor-and Vessel Forceps
200 mm

Delicate Dissecting, Microscopic, Sterilizing Forceps

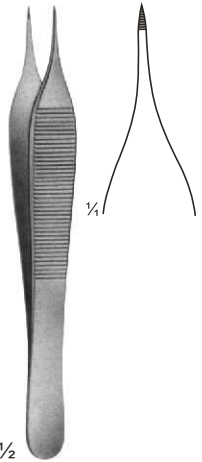

04-150
THORPE
 Corneal Forceps
 120 mm

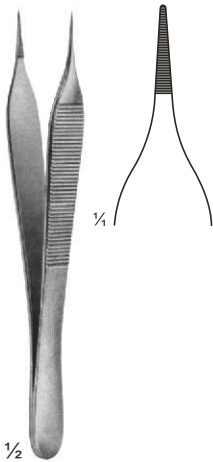

04-151
MICRO-ADSON
 120 mm

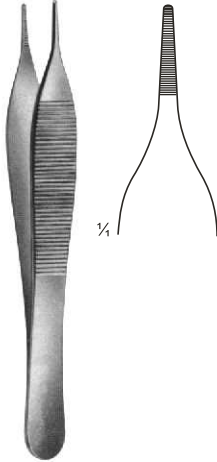

04-152
ADSON
 120 mm

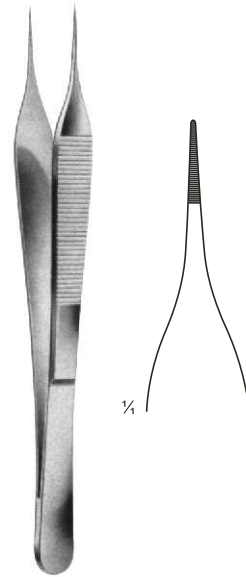

04-153
MICRO-ADSON
 150 mm



04-154 - 156
 100 mm

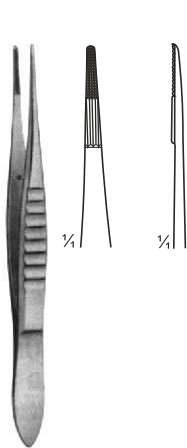
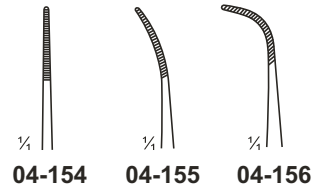

04-157
 110 mm

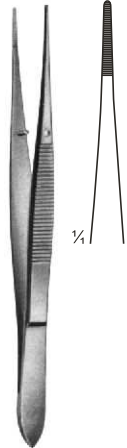

04-158
 115 mm

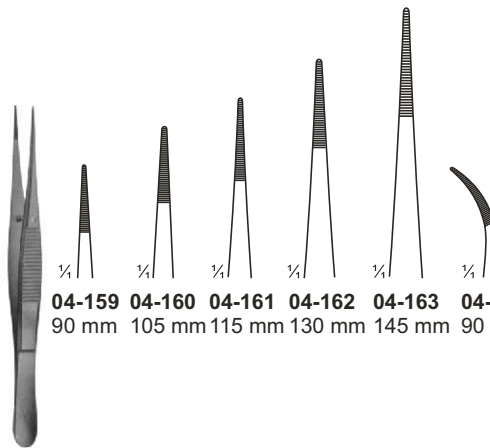

04-159 - 168

04-159 90 mm **04-160** 105 mm **04-161** 115 mm **04-162** 130 mm **04-163** 145 mm **04-164** 90 mm **04-165** 105 mm **04-166** 115 mm **04-167** 130 mm **04-168** 145 mm

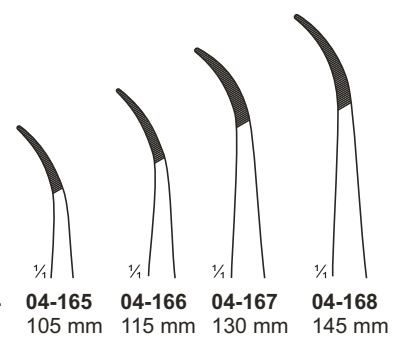

04-172
COVER GLASS FORCEPS
 105 mm

04-173
 160 mm

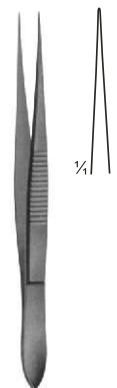

04-169
 100 mm

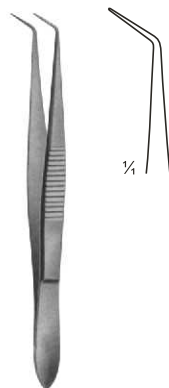

04-170
 100 mm

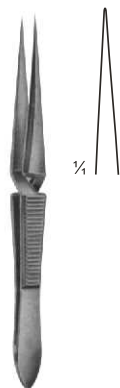

04-171
 100 mm

Delicate Dissecting Forceps

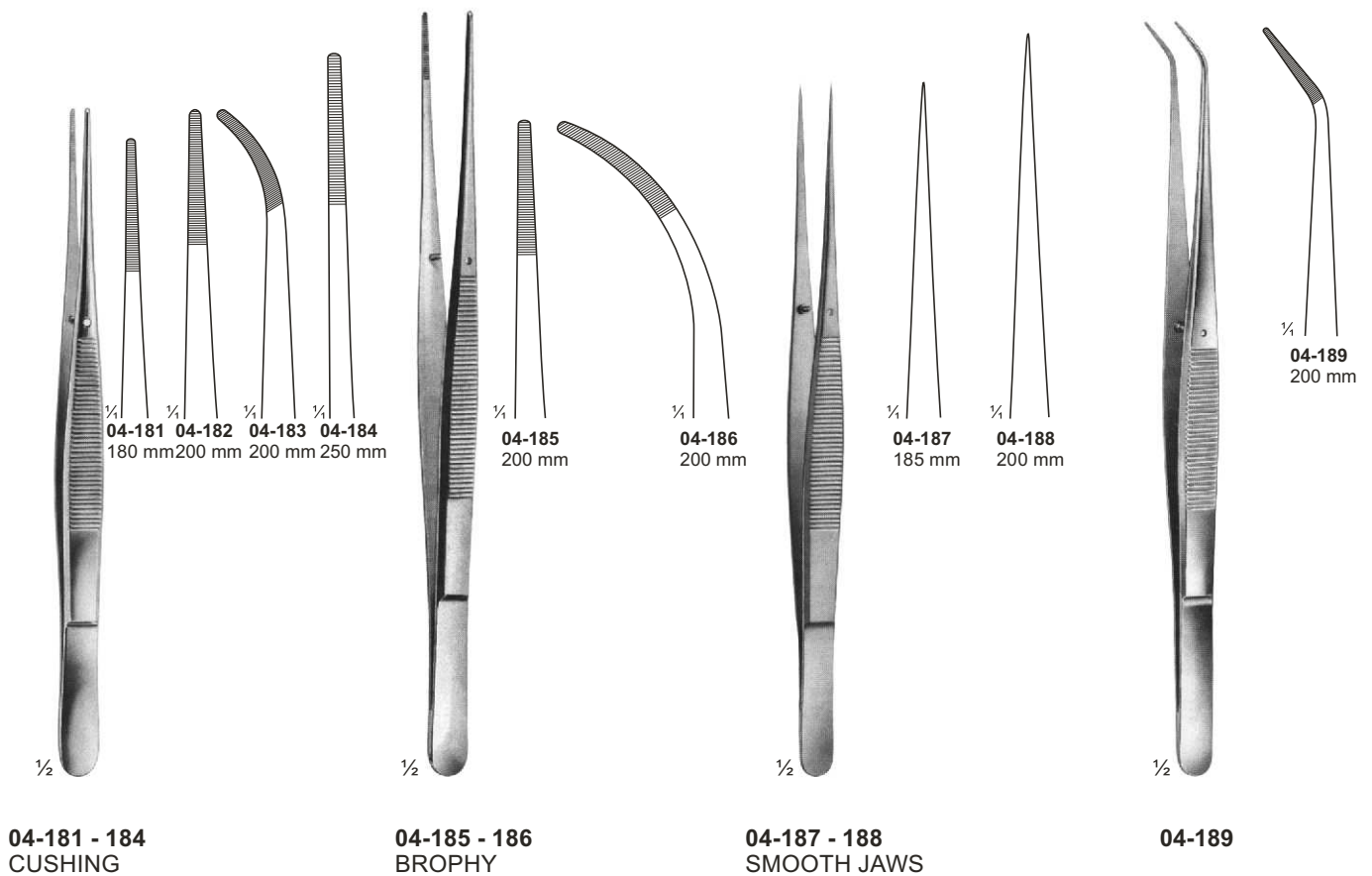
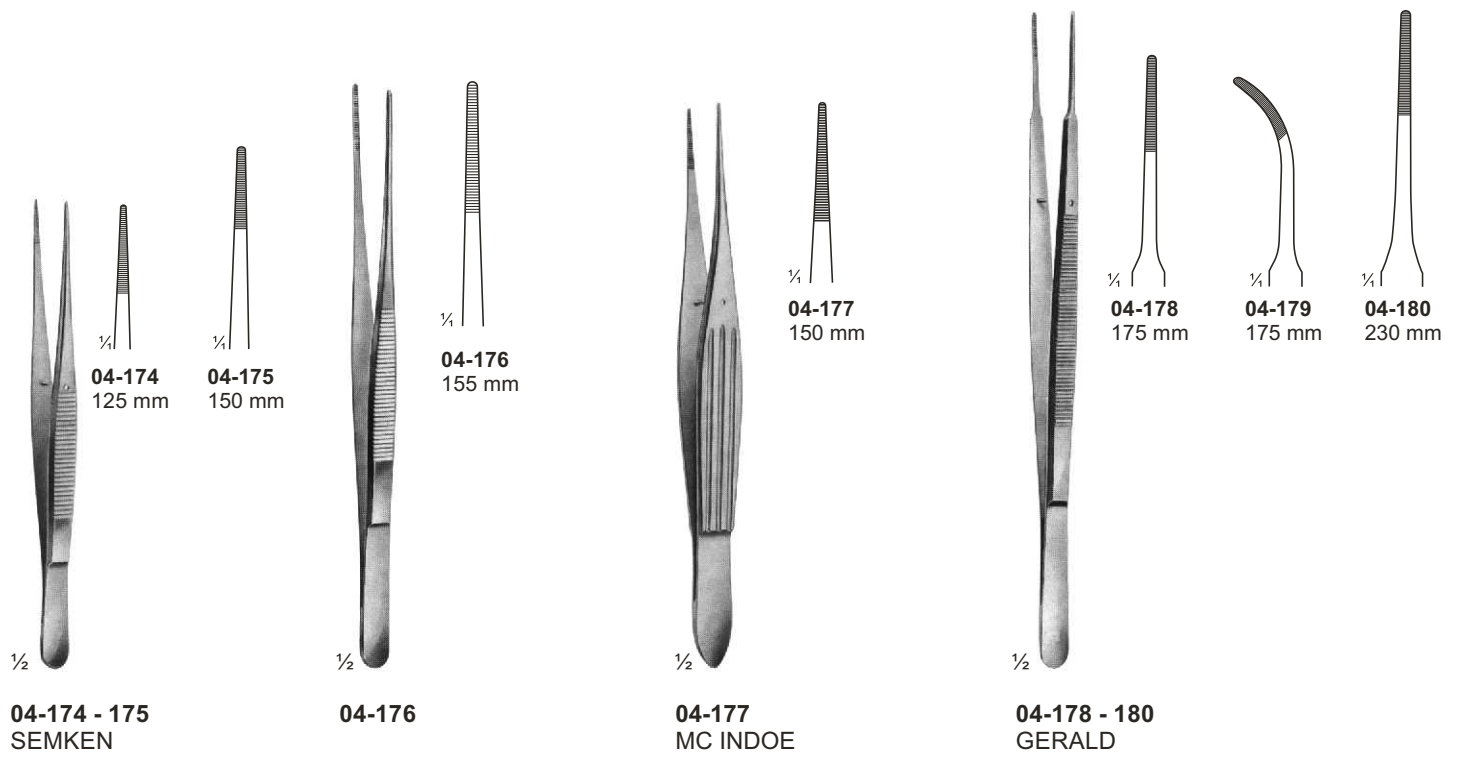

Dissecting Forceps



1/2

04-190 - 197
STANDARD

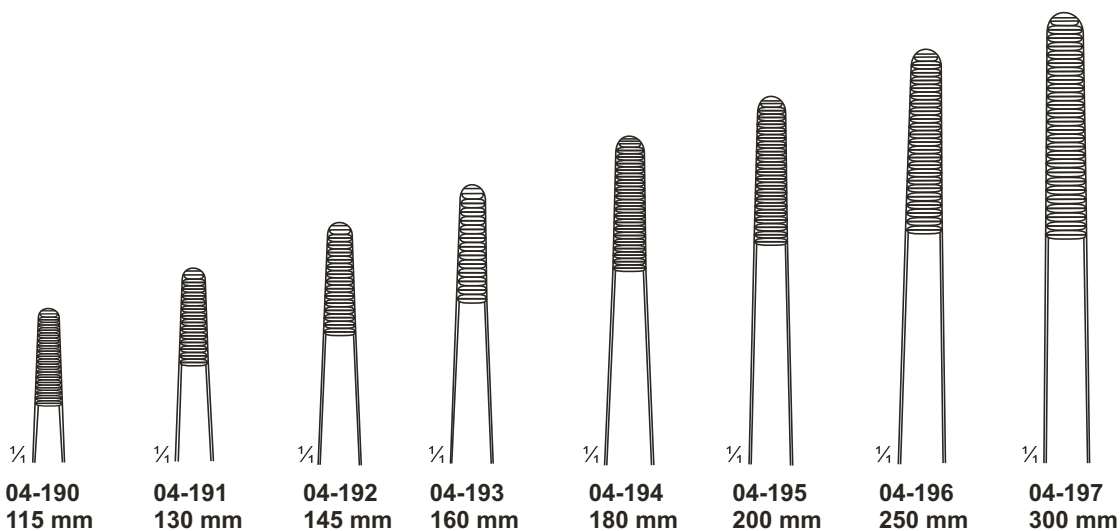

1/2

04-198 - 202
MEDIUM

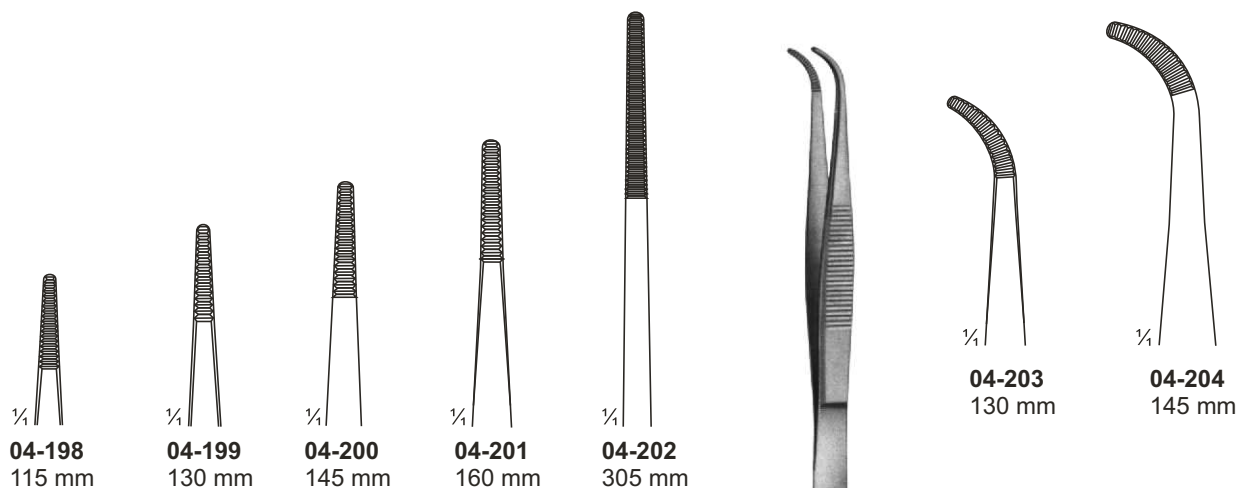

1/2

04-203 - 204
MEDIUM

Dissecting Forceps



04-205 - 206



04-205
125 mm



04-206
155 mm



04-207 - 210

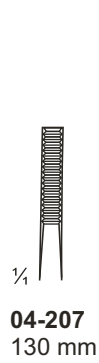

04-207
130 mm



04-208
150 mm



04-209
170 mm

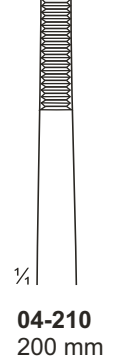

04-210
200 mm



04-211
OCHSNER



04-212
FRICKE



04-213
BONNEY

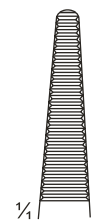

Ultra-Light Forceps

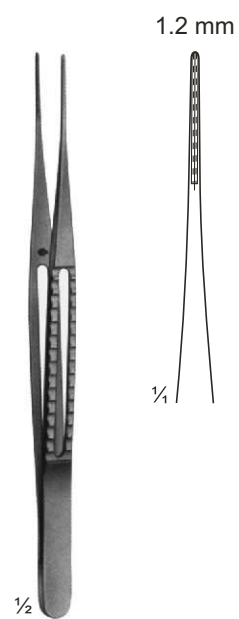

04-214
150 mm

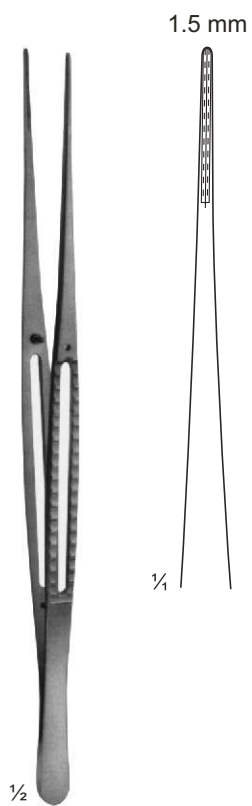

04-215
200 mm

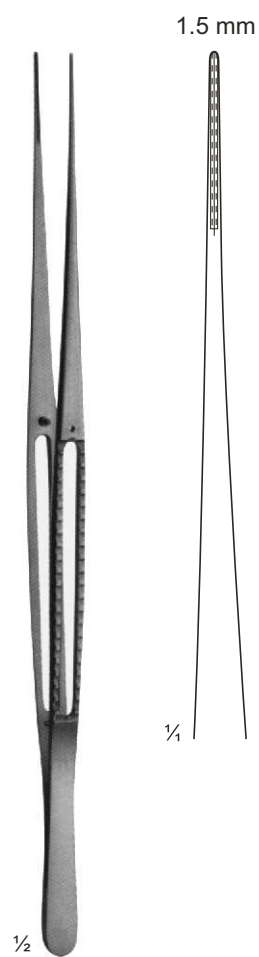

04-216
240 mm

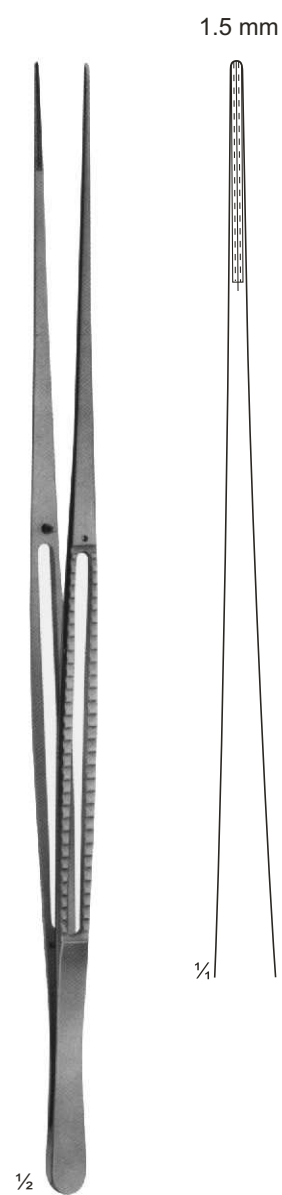

04-217
300 mm

Forceps

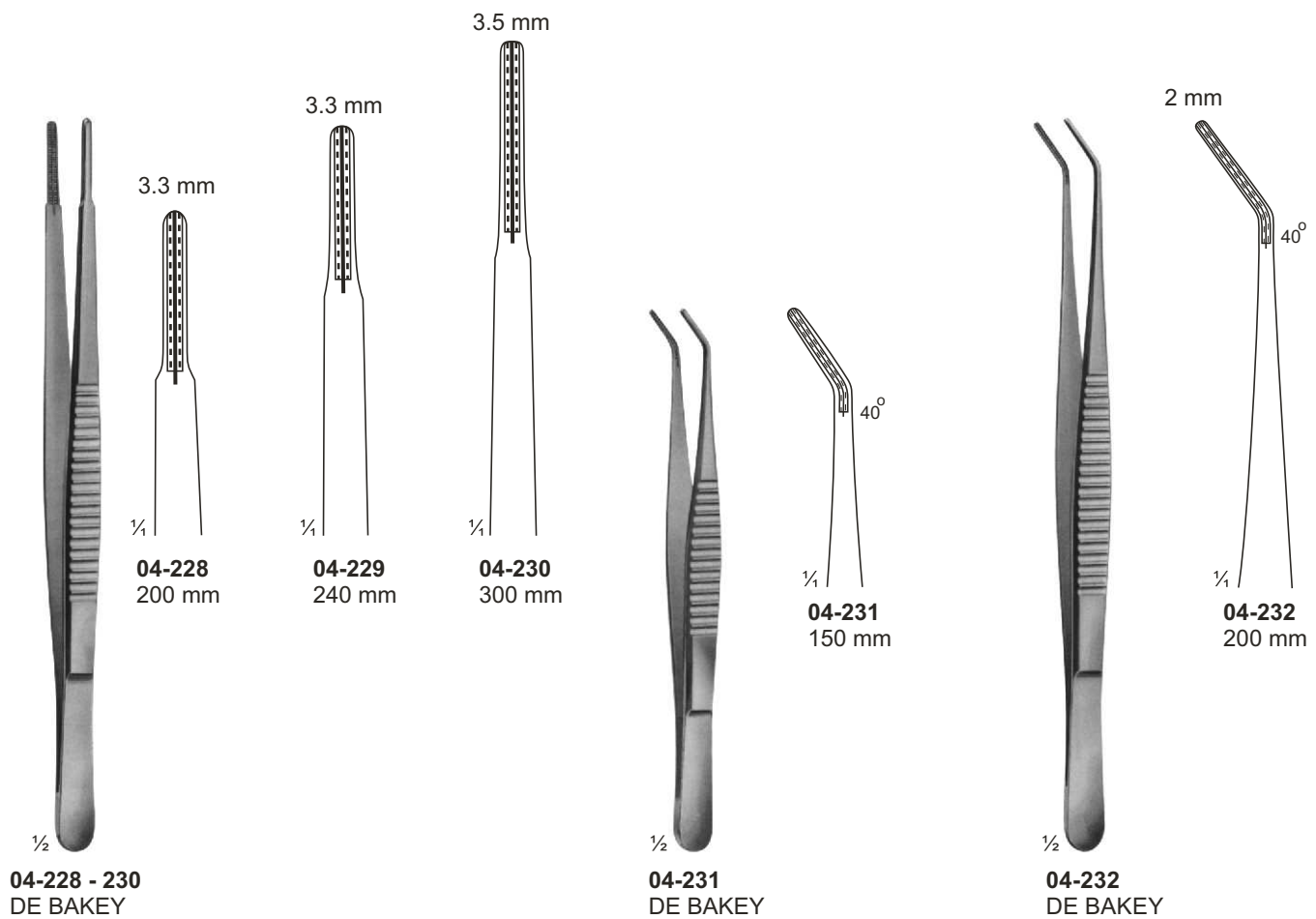
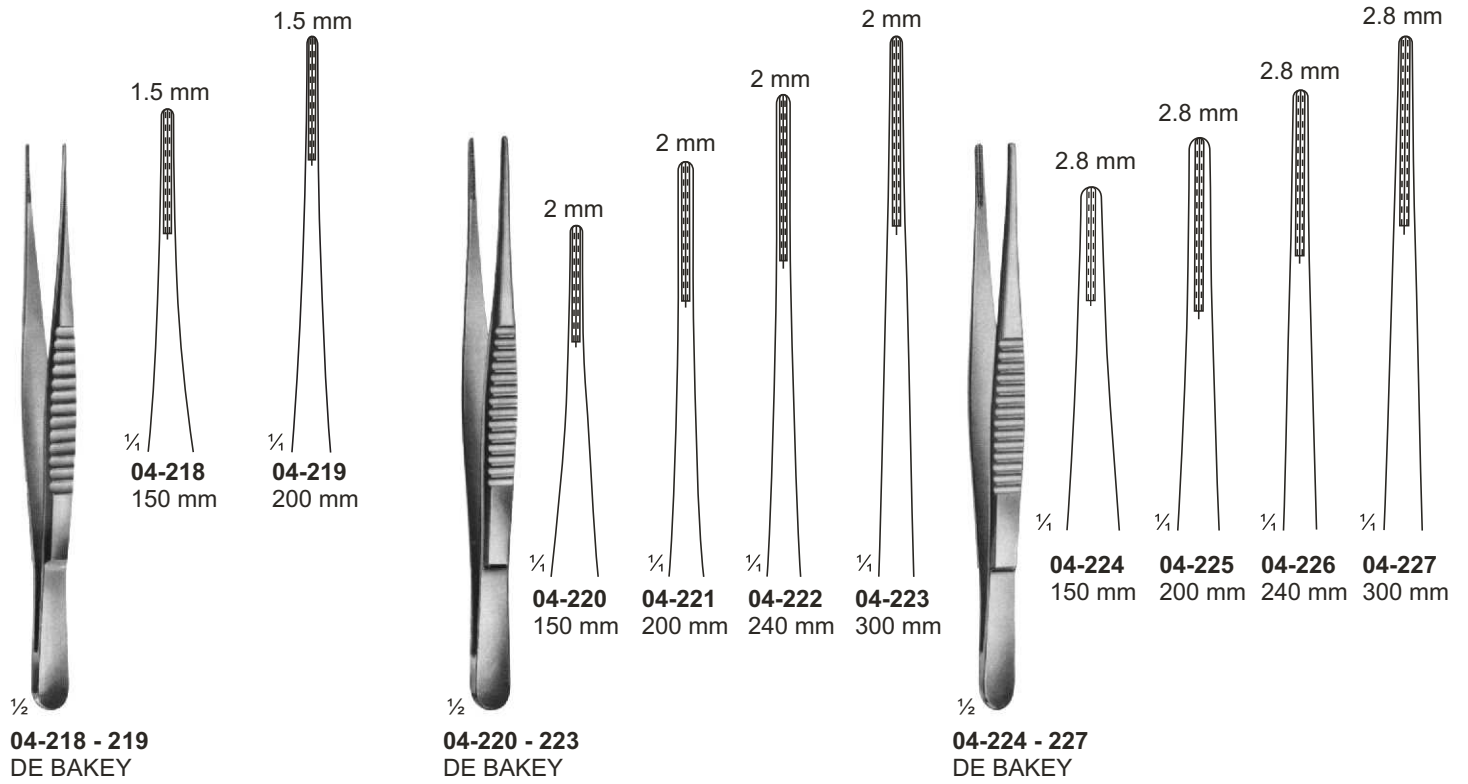

Forceps, Bayonet - Shaped

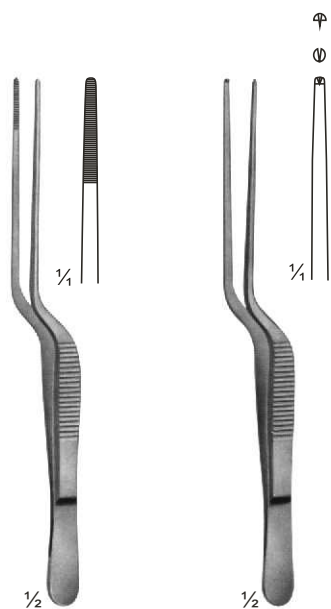

04-233
LUCAE
140 mm

04-234
LUCAE
1x2 teeth
140 mm

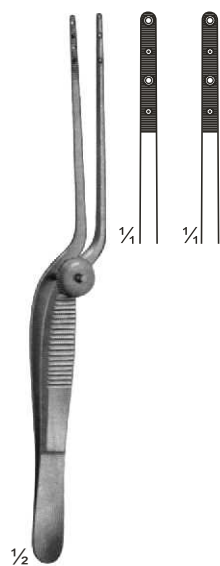

04-235
COTTLE
Forceps with
jaws toothed
and serrated
140 mm



04-236
JANSEN
160 mm

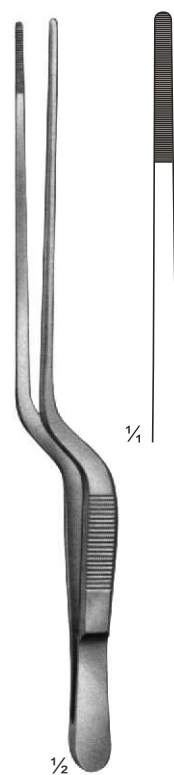

04-237
GRUENWALD
200 mm

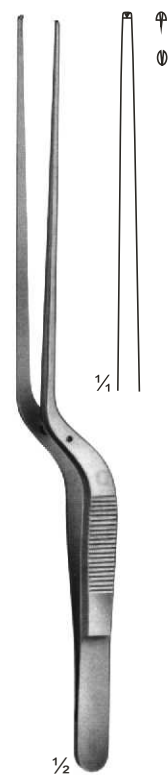

04-238
1x2 teeth
200 mm

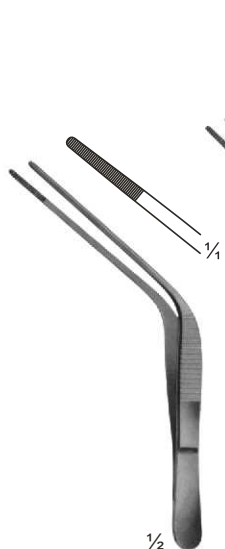

04-239
TROELTSCH
100 mm

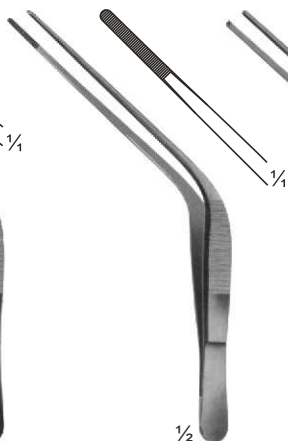

04-240
TROELTSCH
115 mm

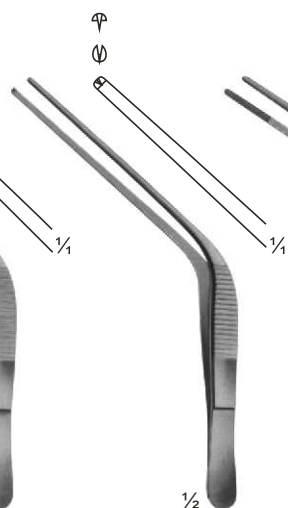

04-241
TROELTSCH
1X2 teeth
115 mm

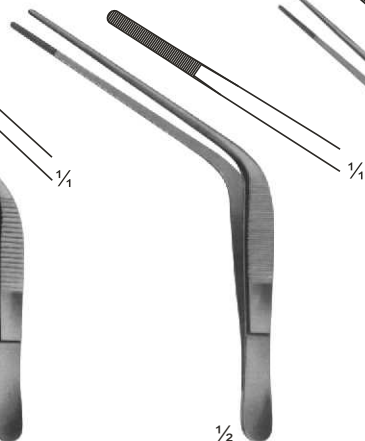

04-242
WILDE
115 mm

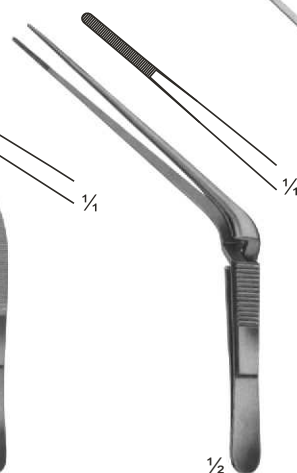

04-243
TROELTSCH
Cross action
120 mm

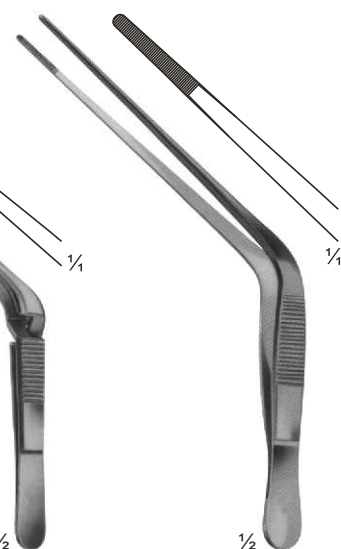

04-244
TROELTSCH
140 mm

Delicate Tissue Forceps

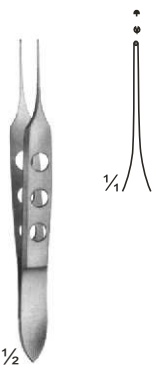

04-245
BISHOP-HARMON
85 mm

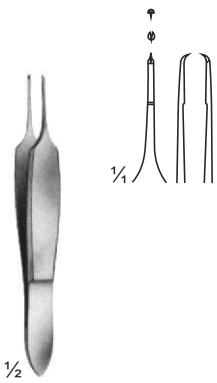

04-246
ST. MARTIN
80 mm

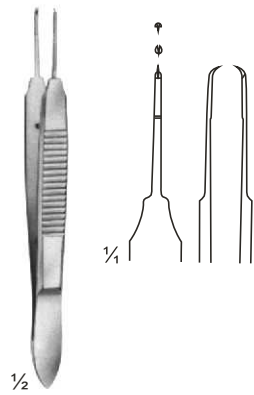

04-247
CASTROVIEJO
teeth 0.9 mm
100 mm

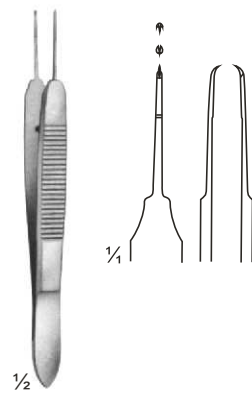

04-248
CASTROVIEJO
teeth 0.5 mm
100 mm

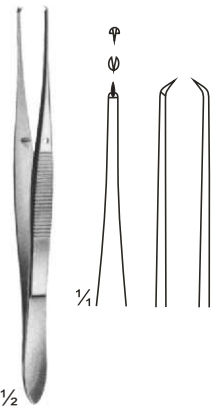

04-249
ELSCHING
110 mm

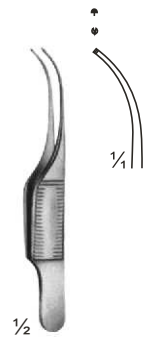

04-250
GILL
75 mm

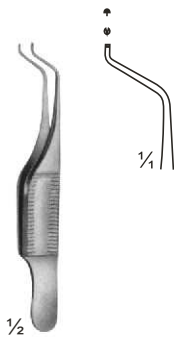

04-251
GILL - HESS
75 mm

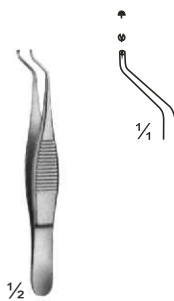

04-252
HESS
70 mm

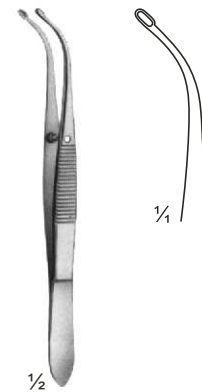

04-253
ARRUGA
100 mm

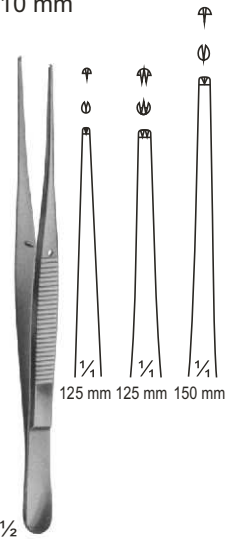

04-254
SEMKEN

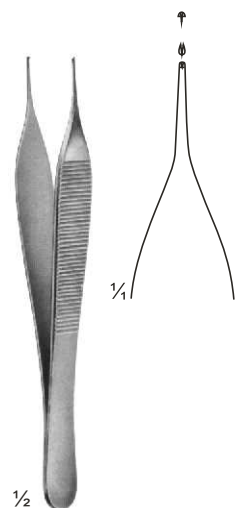

04-255
MICRO-ADSON
120 mm

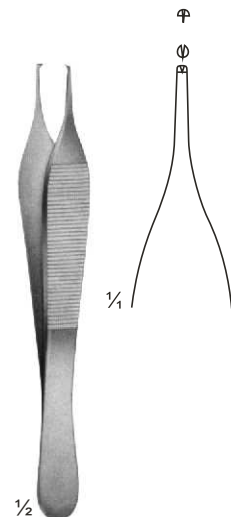

04-256
ADSON
120 mm

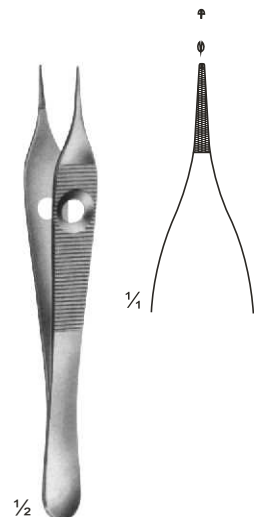

04-257
ADSON
120 mm



04-258
ADSON
120 mm

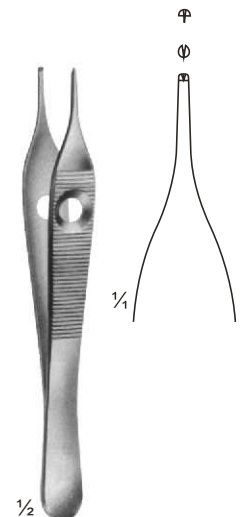

04-259
ADSON
150 mm

Tissue Forceps

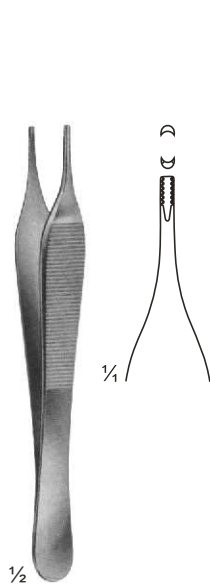

04-260
ADSON - BROWN
Non-traumatic
120 mm

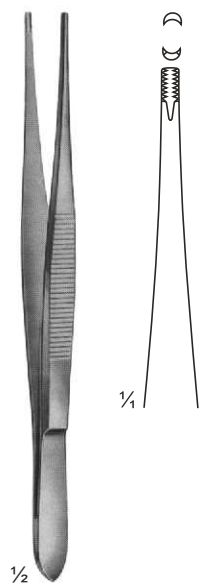

04-261
BROWN
120 mm

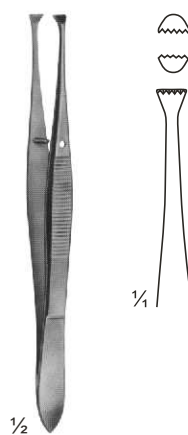

04-262
GRAEFE
110 mm

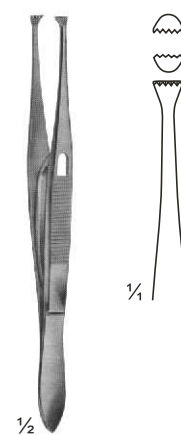

04-263
GRAEFE
With Catch
110 mm

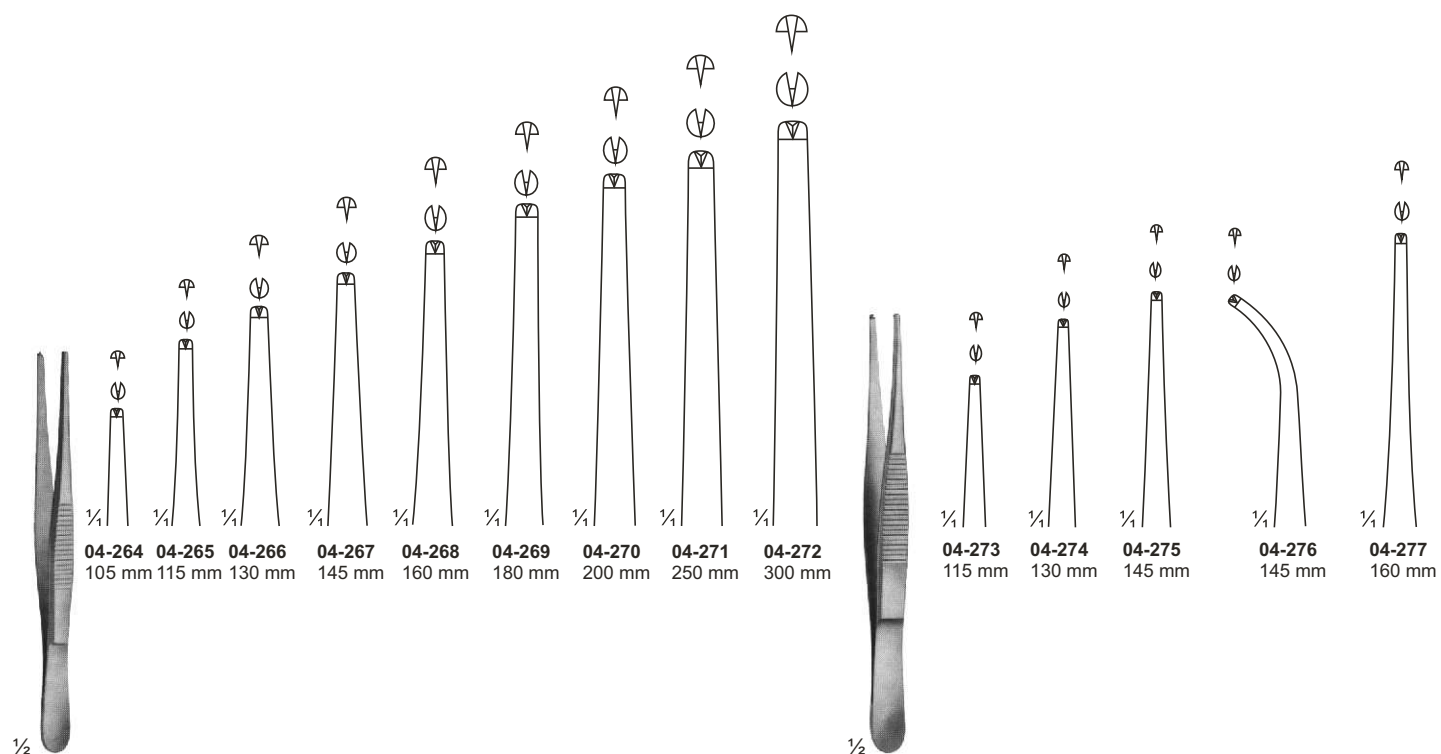

04-264 - 272
STANDARD

04-273 - 277
GRAEFE
110 mm

Tissue Forceps

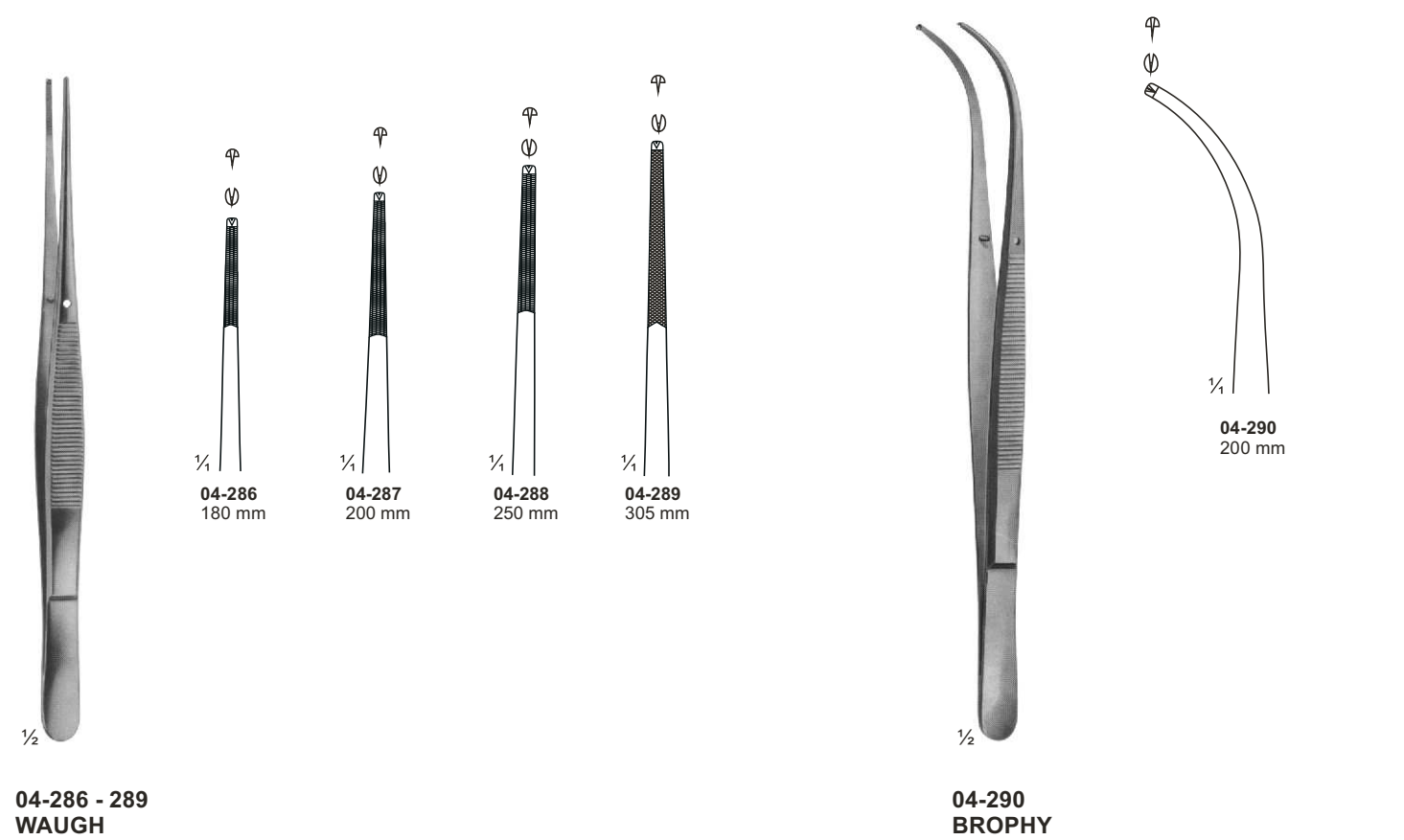
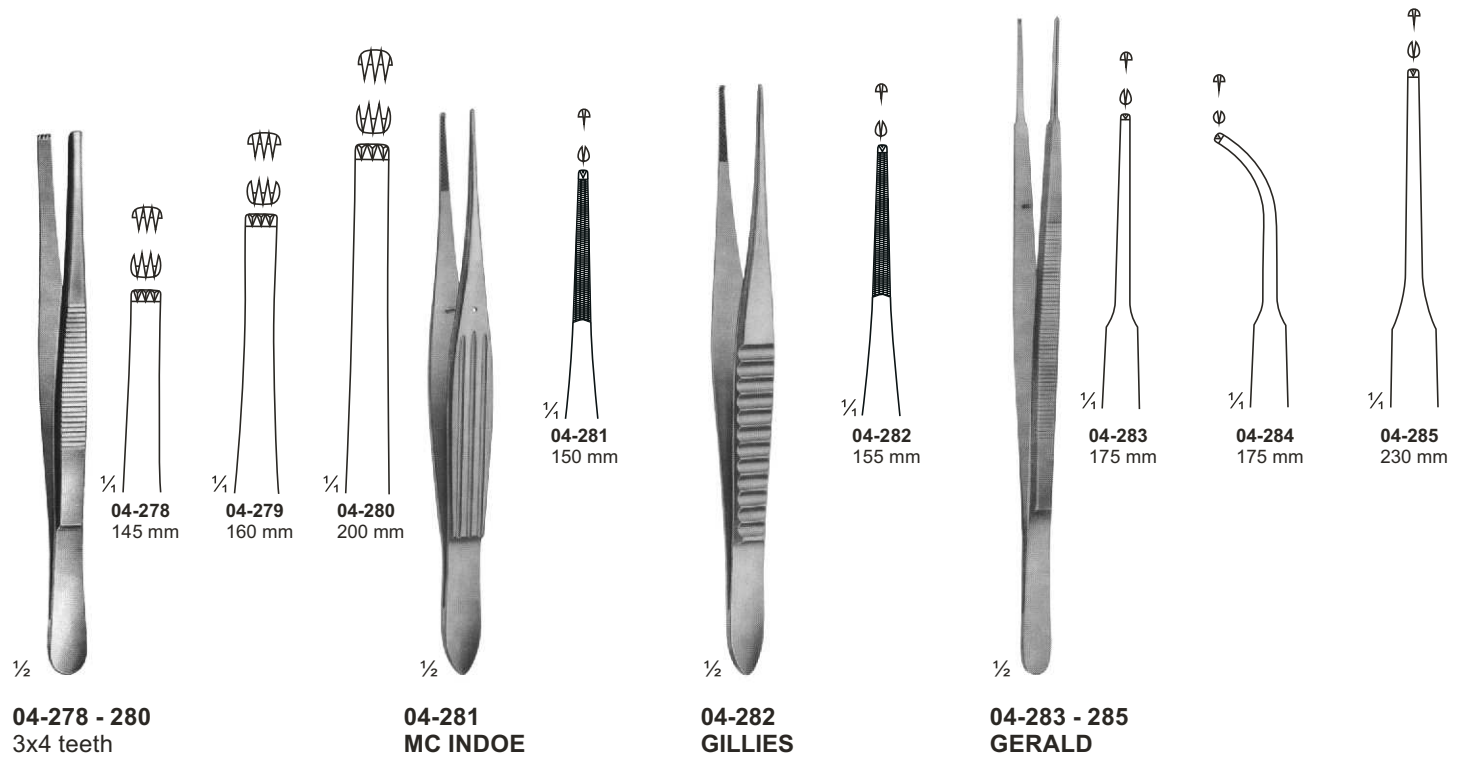

Tissue Forceps, Lung Dissecting Forceps

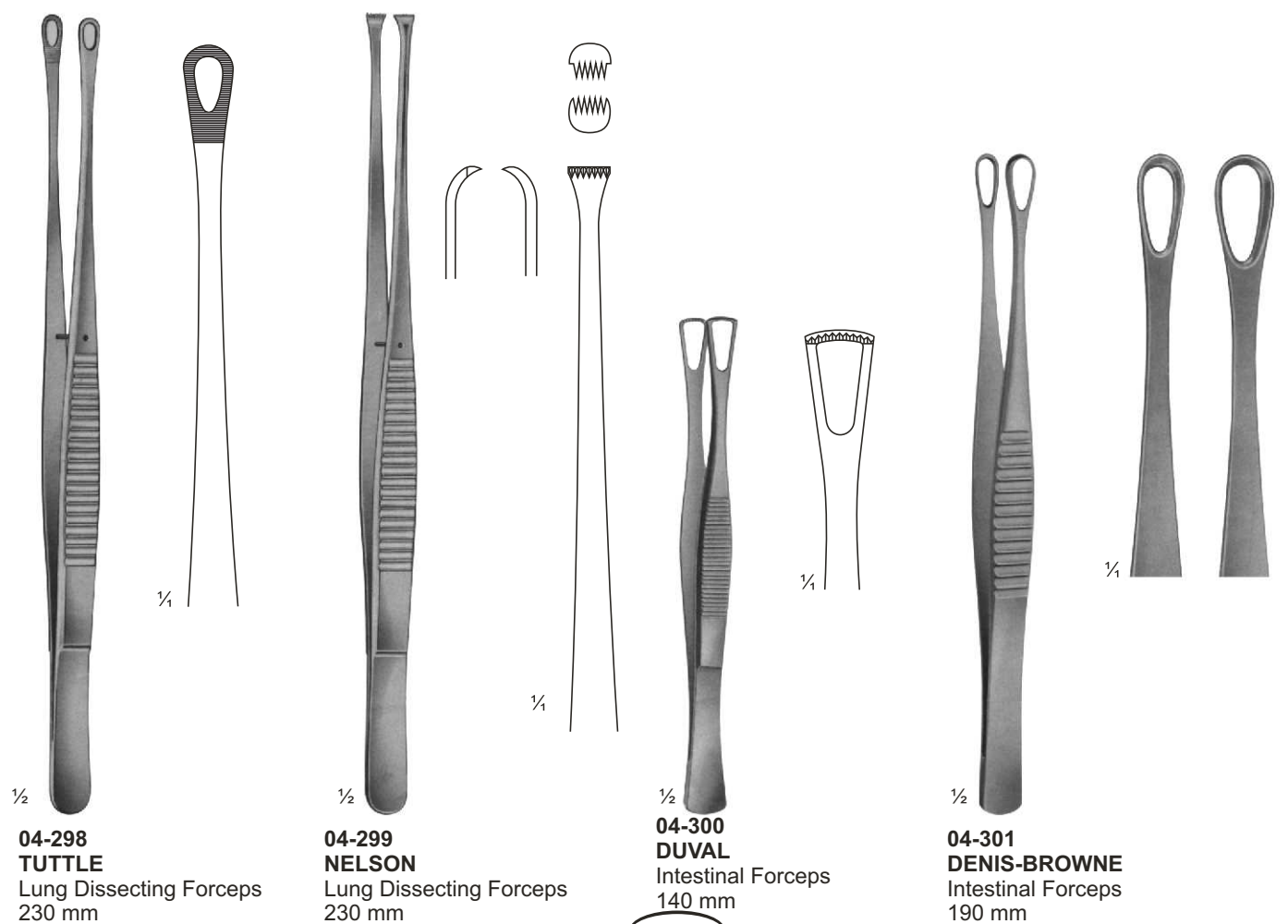
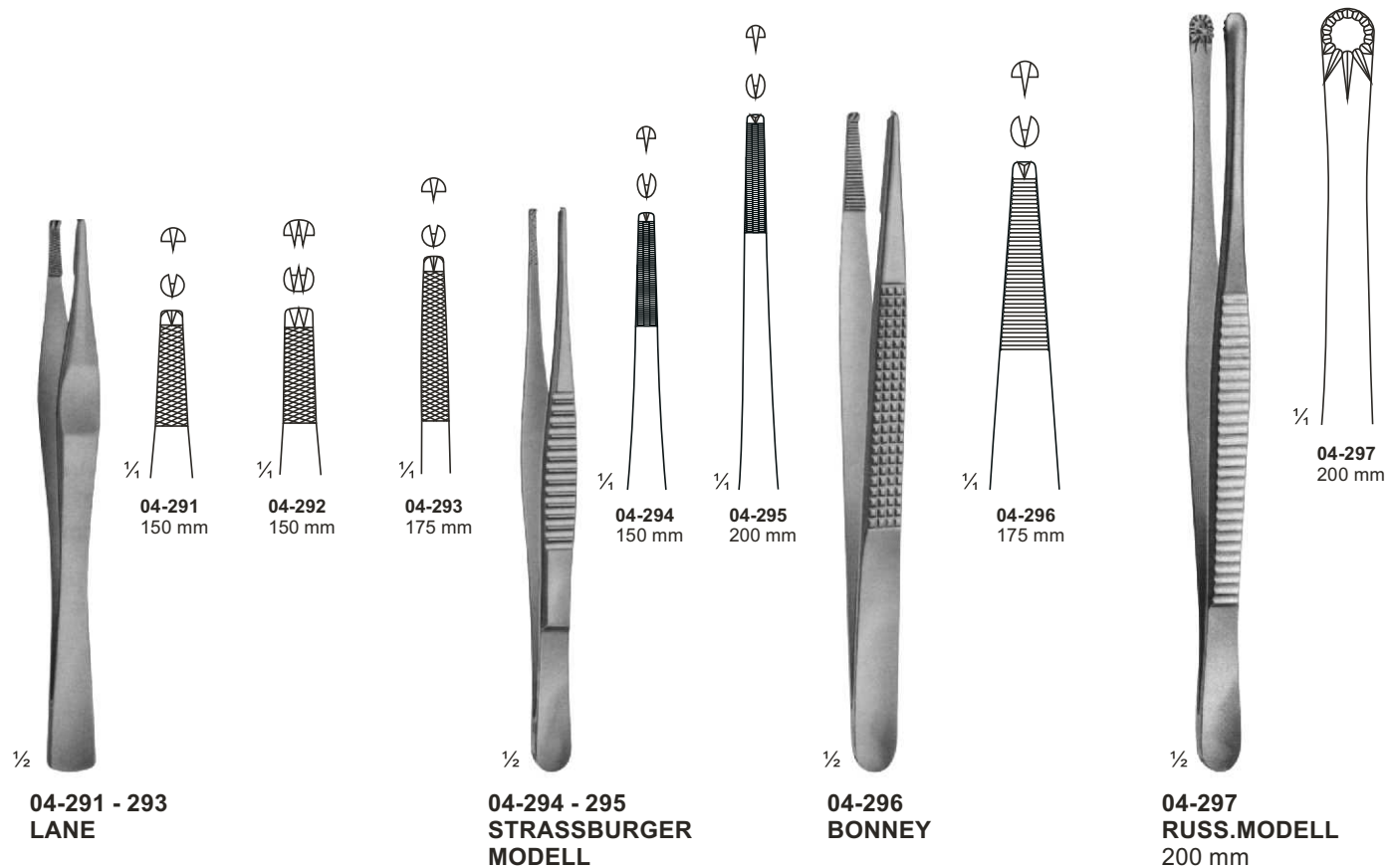

Splinter and Cilia Forceps

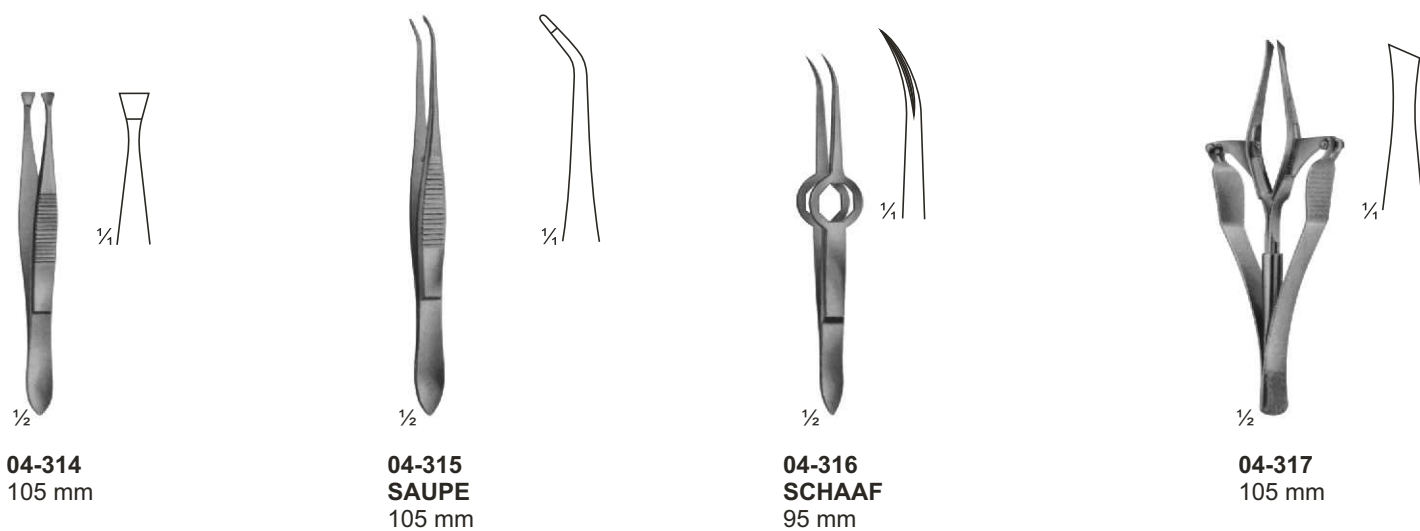
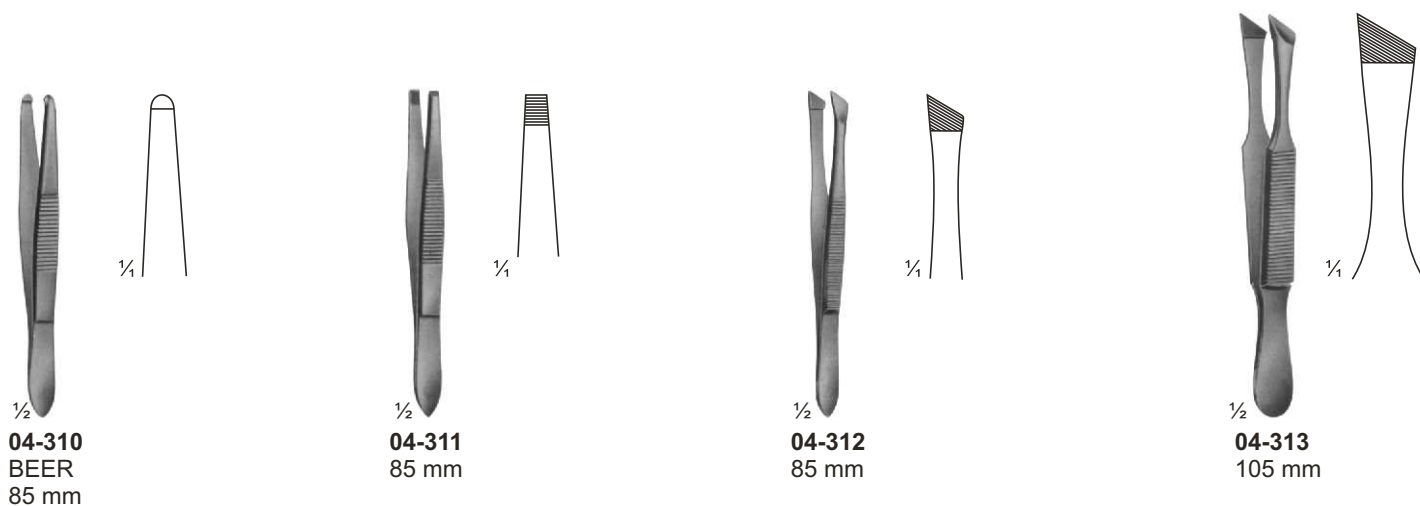
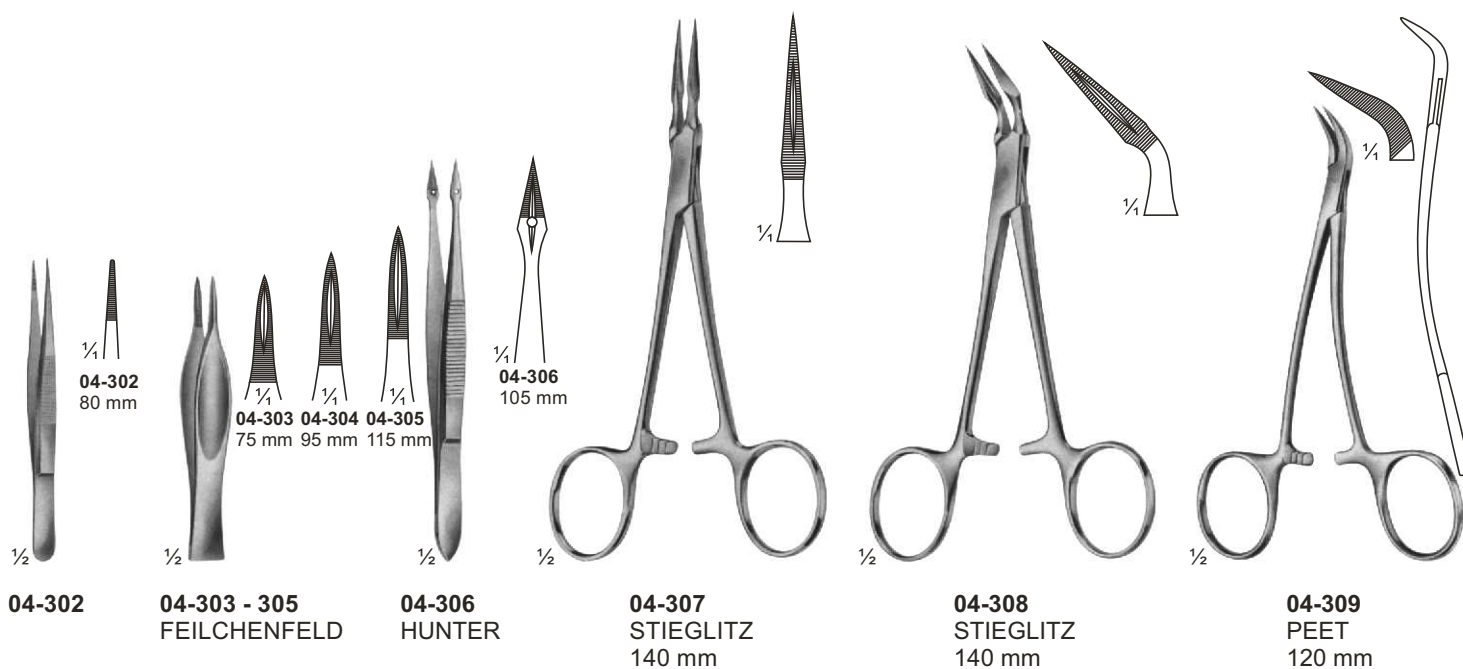

Sponge and Dressing Forceps

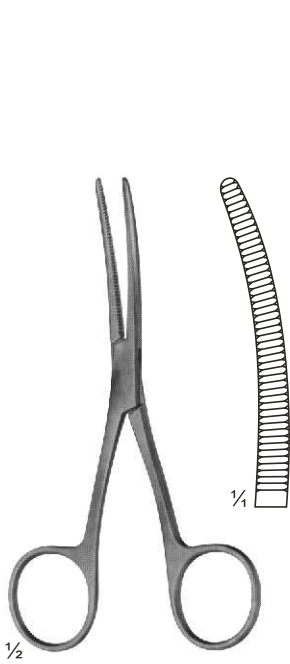

04-318
BRYANT
130 mm

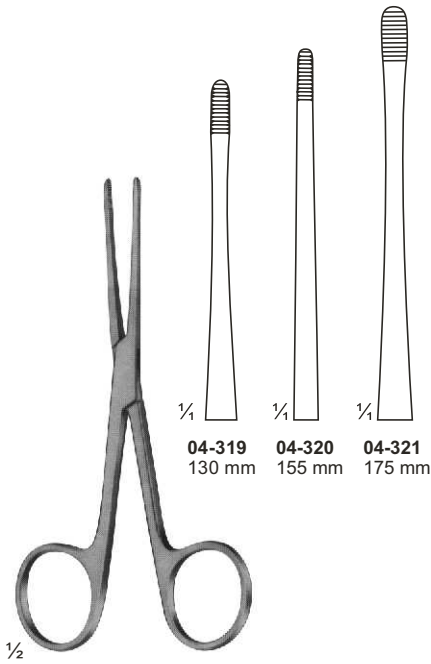

04-319 - 321
LISTER
Sinus Forceps

04-319 130 mm
04-320 155 mm
04-321 175 mm

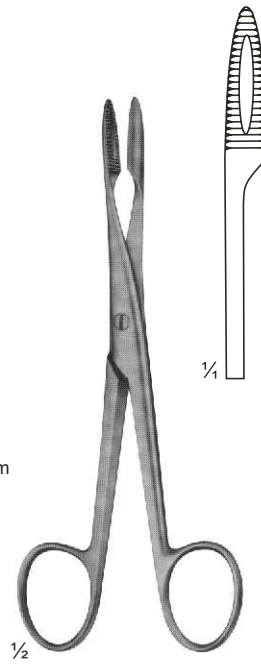

04-322
Without Ratchet
145 mm

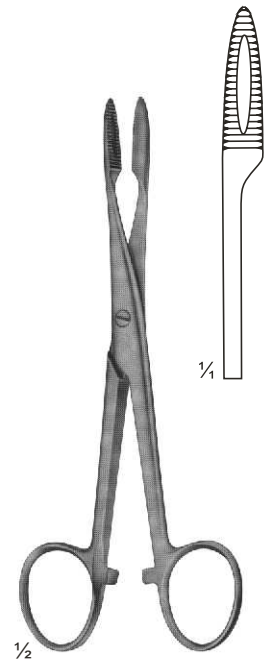

04-323
With Ratchet
145 mm

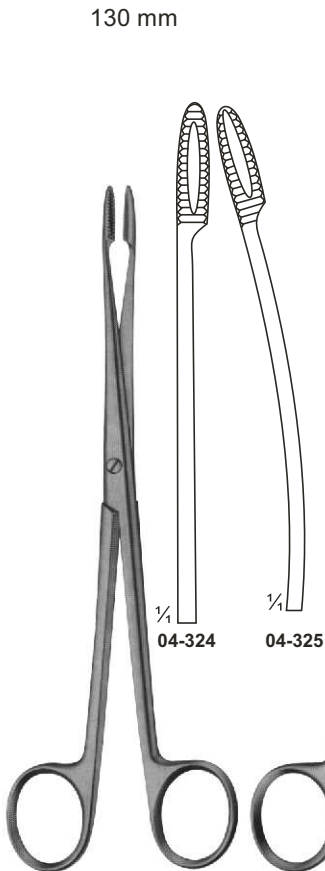

04-324 - 325
GROSS
Without Ratchet
200 mm

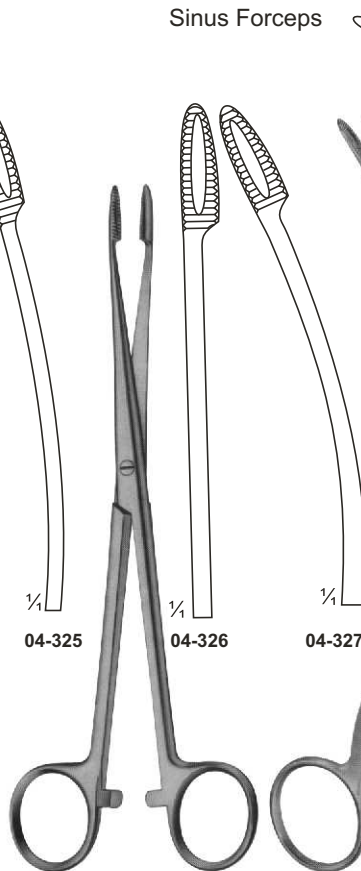

04-326 - 327
GROSS
With Ratchet
180 mm

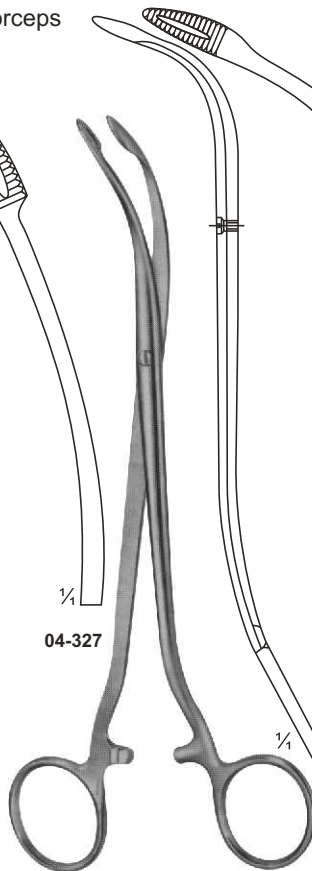

04-328
DUPLAY
190 mm

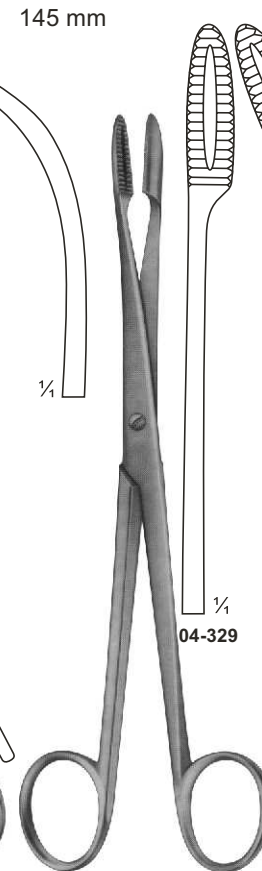

04-329 - 330
GROSS
Without Ratchet
200 mm

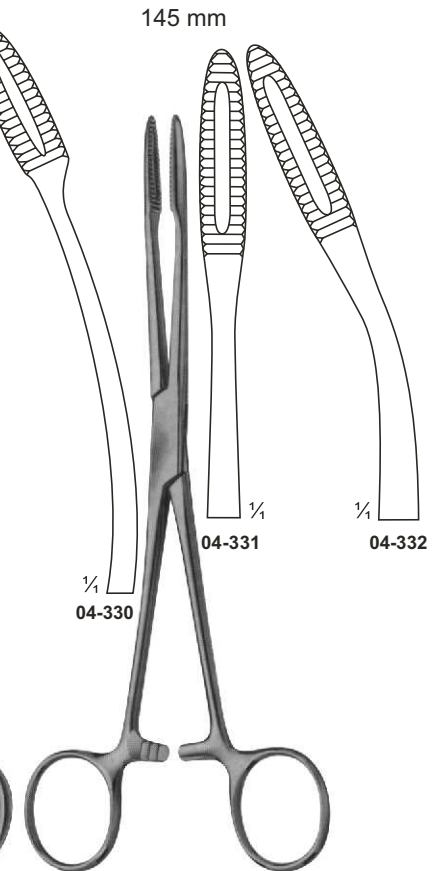

04-331 - 332
GROSS
With Ratchet
200 mm

Sponge and Dressing Forceps



04-333 - 334
AESCULAP
 220 mm

04-335 - 336
MAIER
 Without Ratchet
 265 mm

04-337 - 338
MAIER
 With Ratchet
 265 mm

Sponge and Dressing Forceps

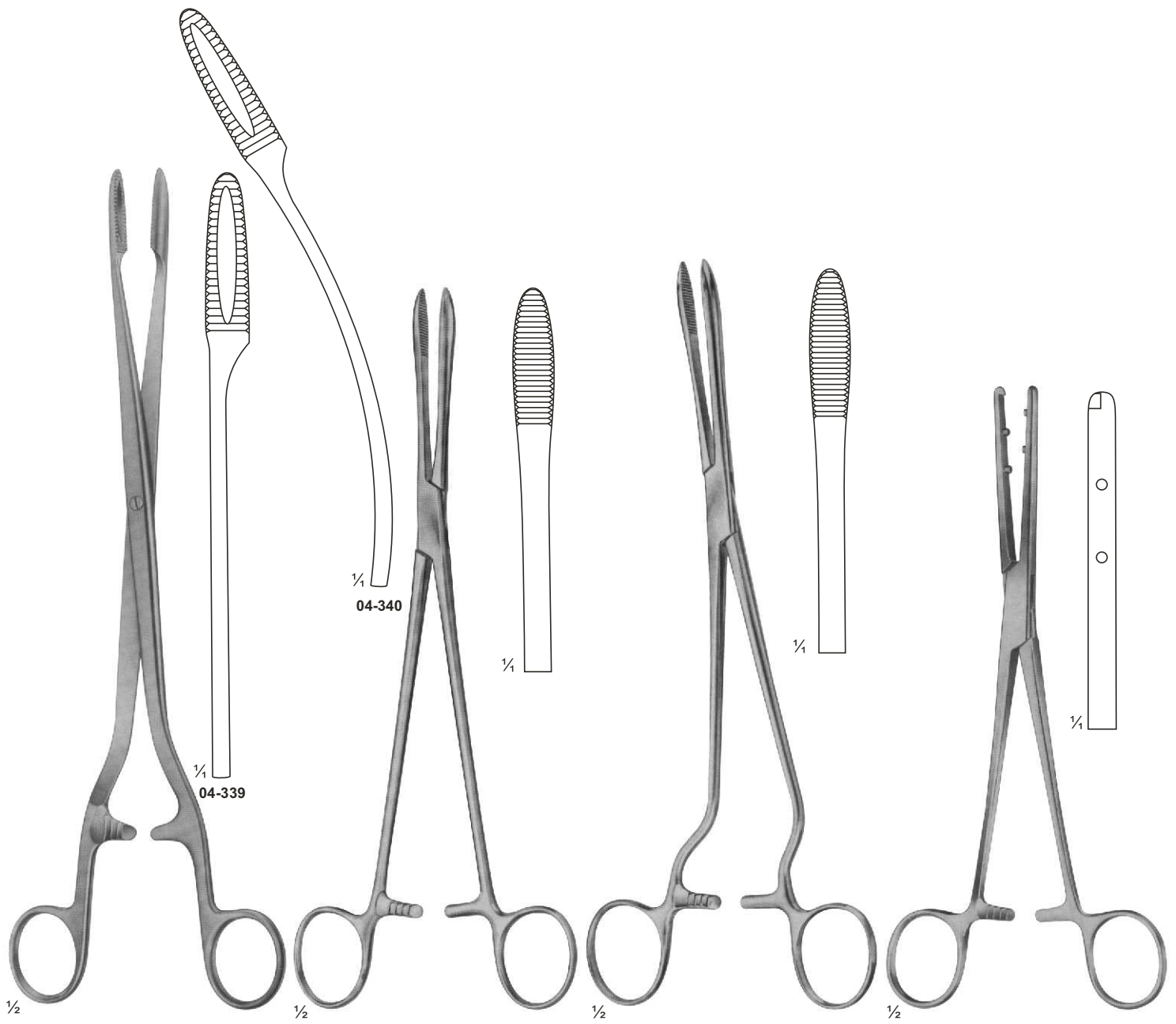

04-339 - 340
SIMS-MAIER
280 mm

04-341
COLLIN
240 mm

04-342
CHERON
Handles Laterally Angled
240 mm

04-343
EMMET
210 mm

Dressing, Sponge holding, Organ and Tissue Grasping Forceps

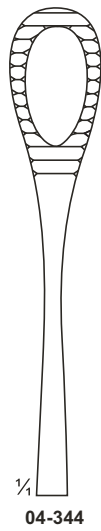
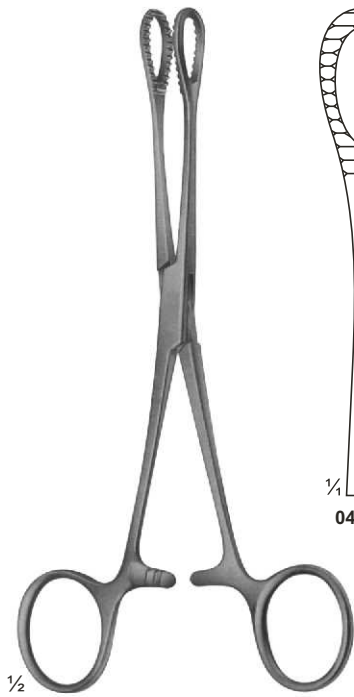

04-344



04-345

04-344 - 345
FOERSTER-BALLENGER
180 mm



04-346
180 mm

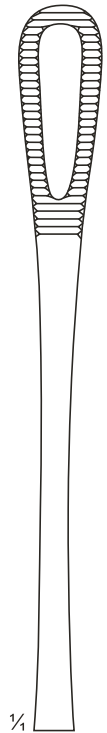

04-347
250 mm

04-346 - 347
RAMPLEY

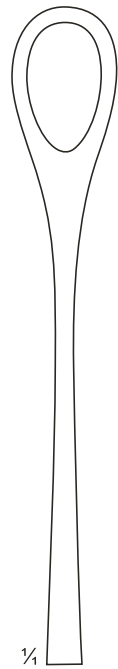
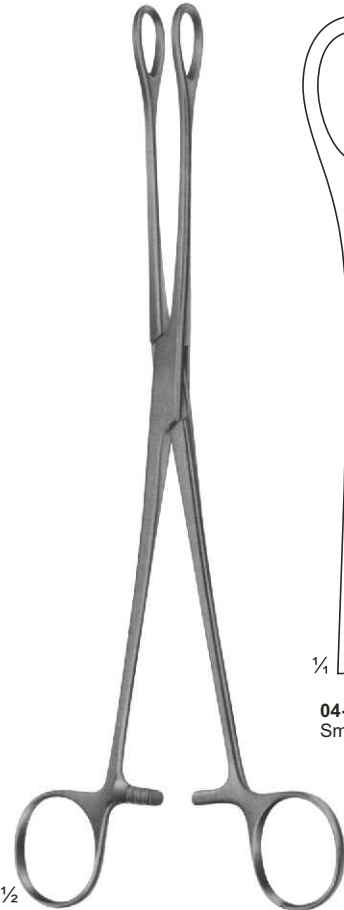

04-348
Smooth Jaws

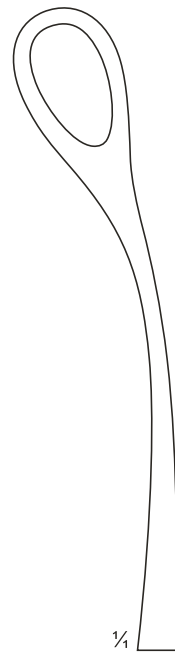

04-349
Smooth Jaws

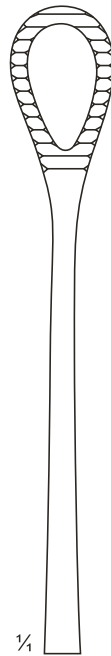

04-350
Serrated Jaws

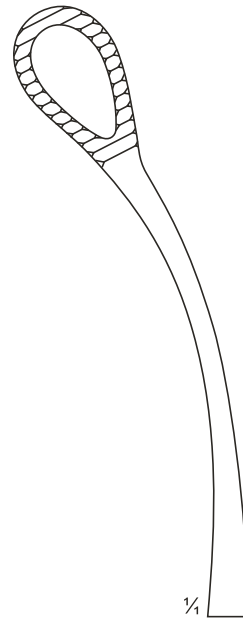

04-351
Serrated Jaws

04-348 - 351
FOERSTER-BALLENGER
240 mm

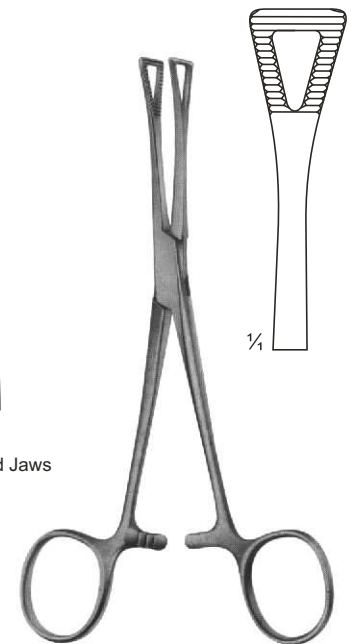

04-352
PENNINGTON
155 mm

Dressing, Sponge holding, Organ and Tissue Grasping Forceps

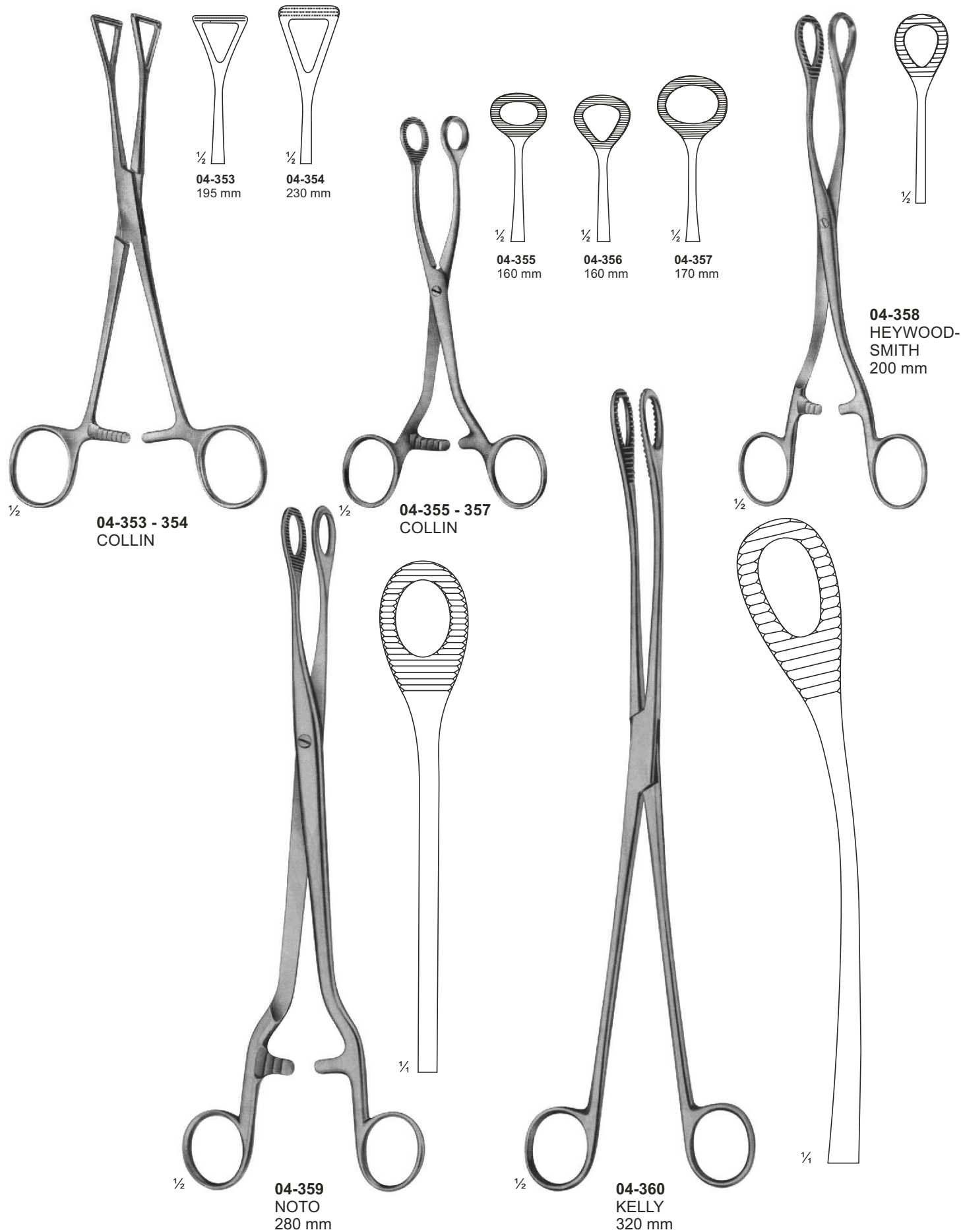

Tendon Seizing Forceps

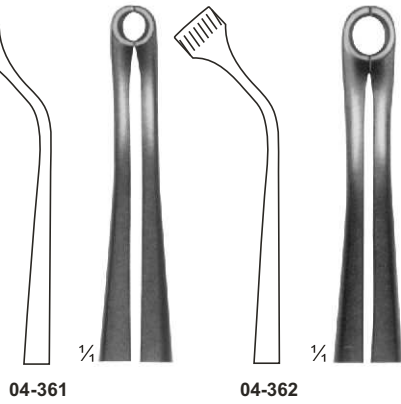
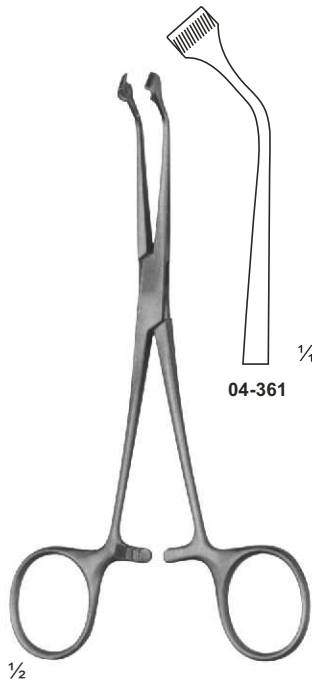

04-361 - 362
HERZ
155 mm

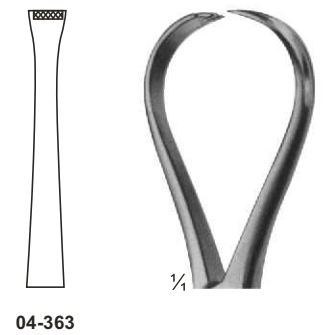
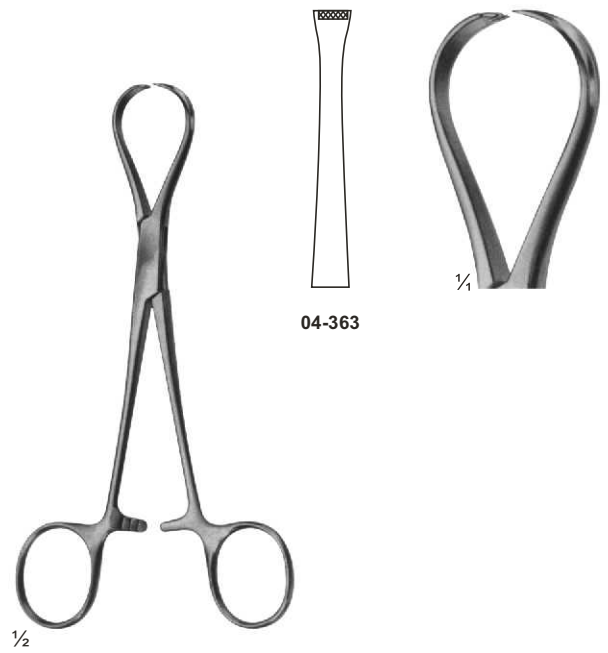

04-363
JACKSON
4 x 5 teeth
150 mm

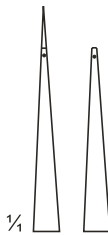
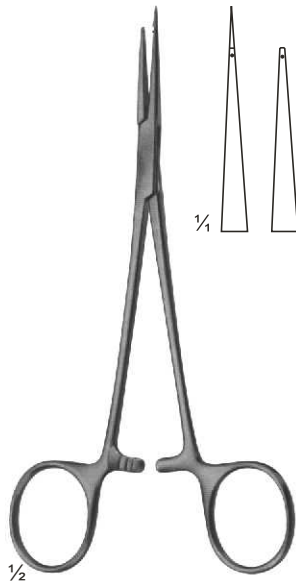

04-364
150 mm

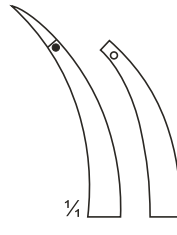
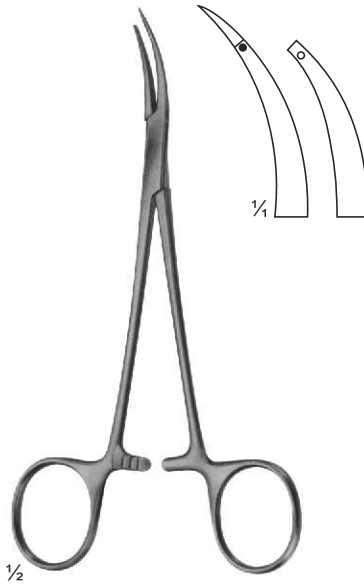

04-365
150 mm

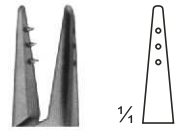

04-366
120 mm

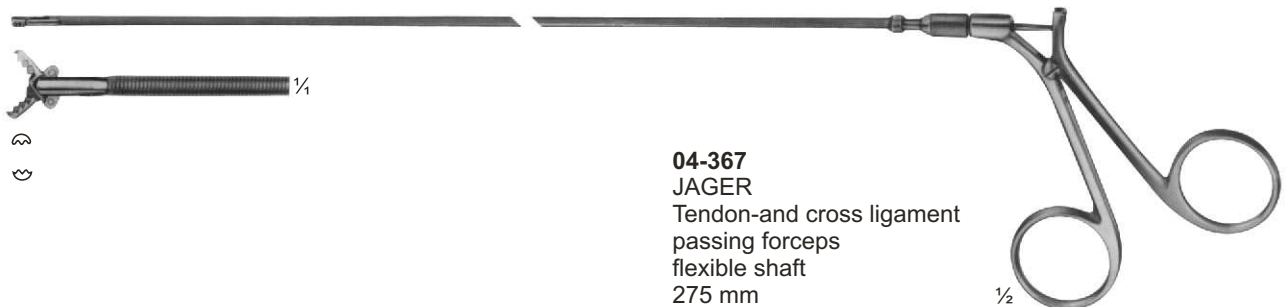

04-367
JAGER
Tendon-and cross ligament
passing forceps
flexible shaft
275 mm

Artery Traction - and Tissue Grasping Forceps

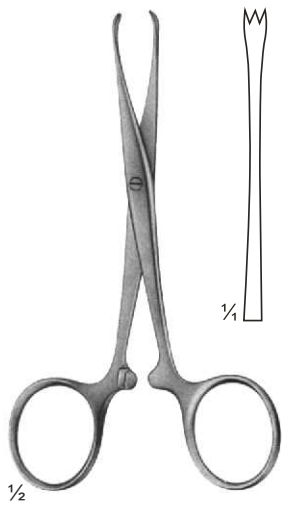

04-368
CHAPUT
 2 x 3 teeth
 125 mm

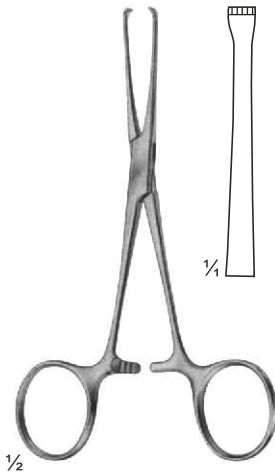

04-369
BABY-ALLIS
 4 x 5 teeth
 130 mm

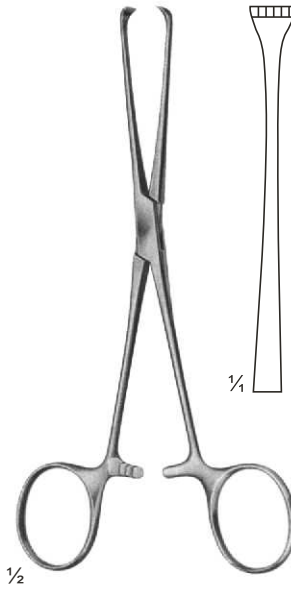

04-370
BOYS-ALLIS
 5 x 6 teeth
 155 mm

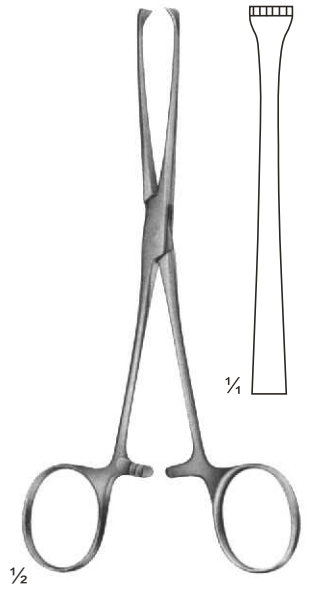

04-371
ALLIS
 5 x 6 teeth
 155 mm

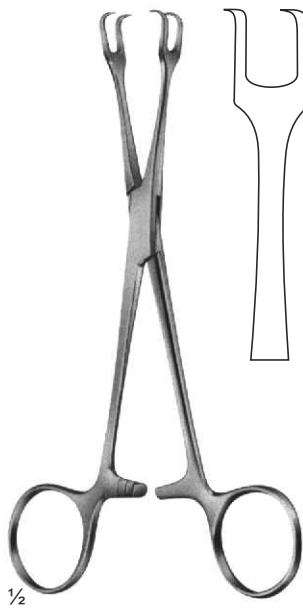

04-372
LAHEY
 135 mm

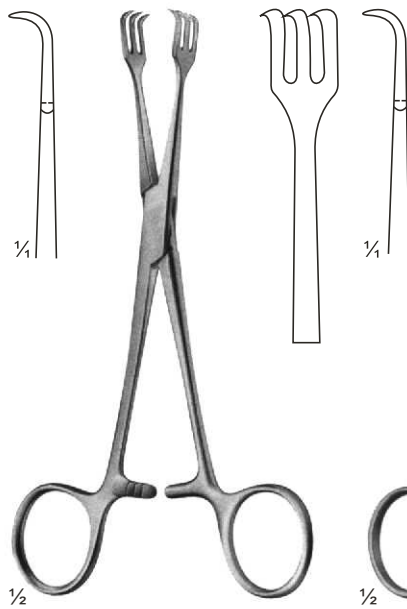

04-373
LAHEY
 135 mm

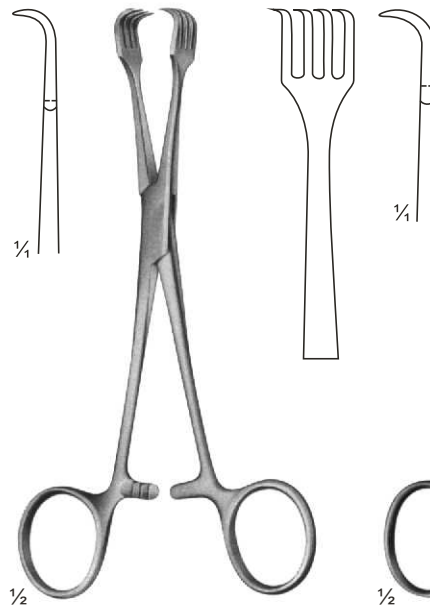

04-374
BRAUN
 155 mm

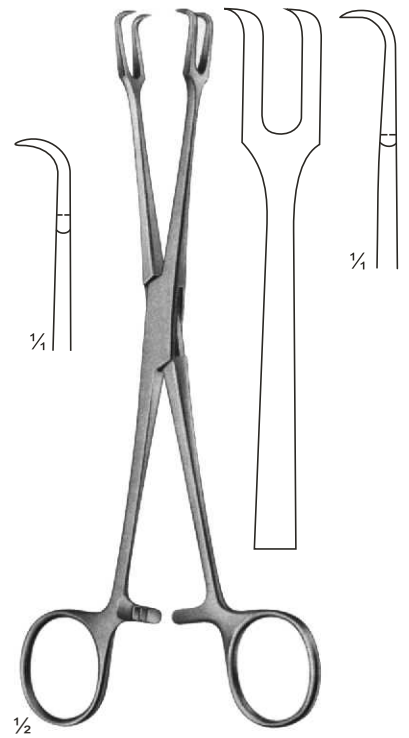

04-375
MUSEUX
 200 mm

Organ - and Tissue Grasping Forceps

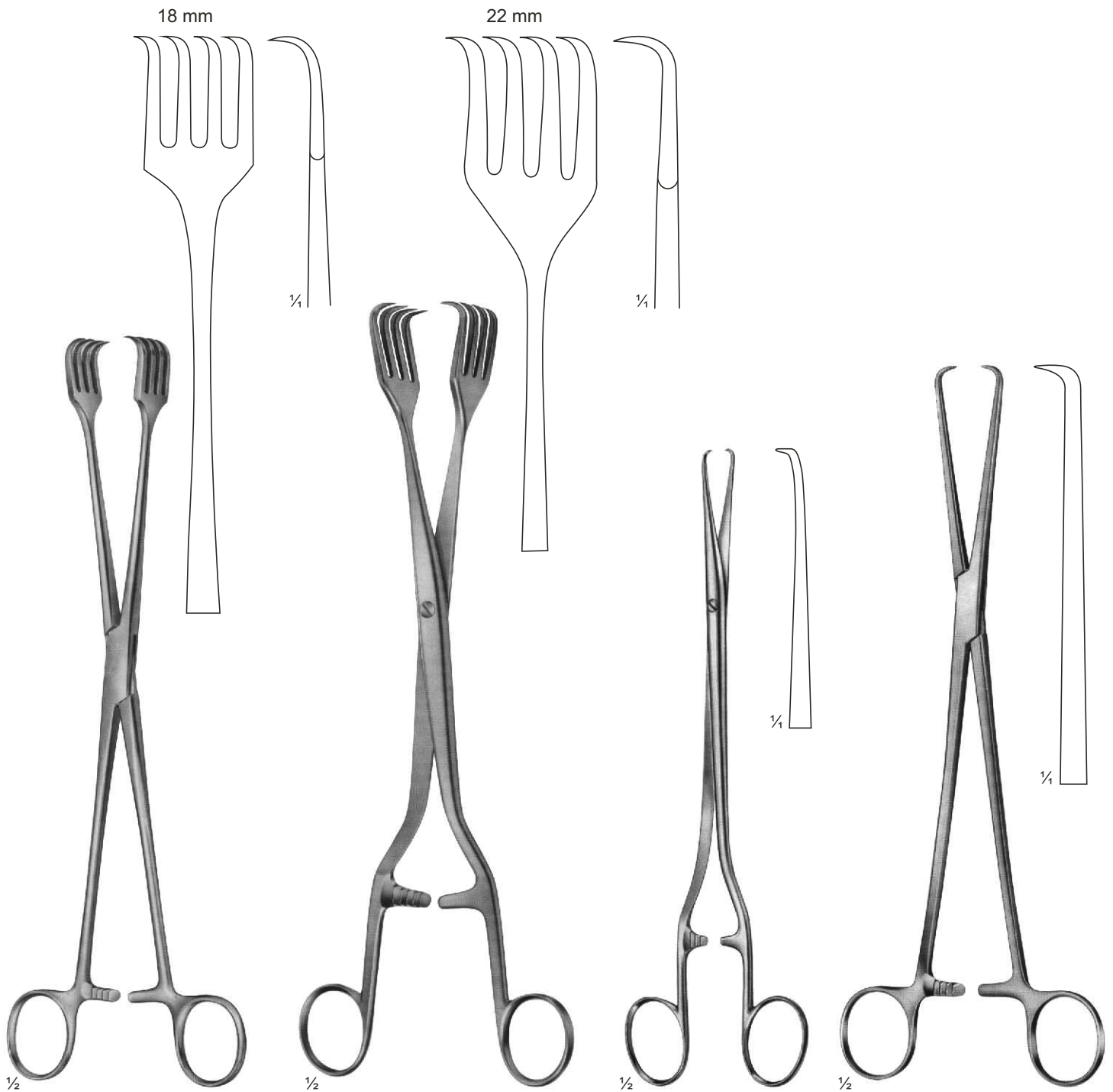

04-376
AESCULAP
260 mm

04-377
PRATT
270 mm

04-378
TIEMANN
Bullet forceps
220 mm

04-379
SCHRODER
250 mm

Towel Clamps

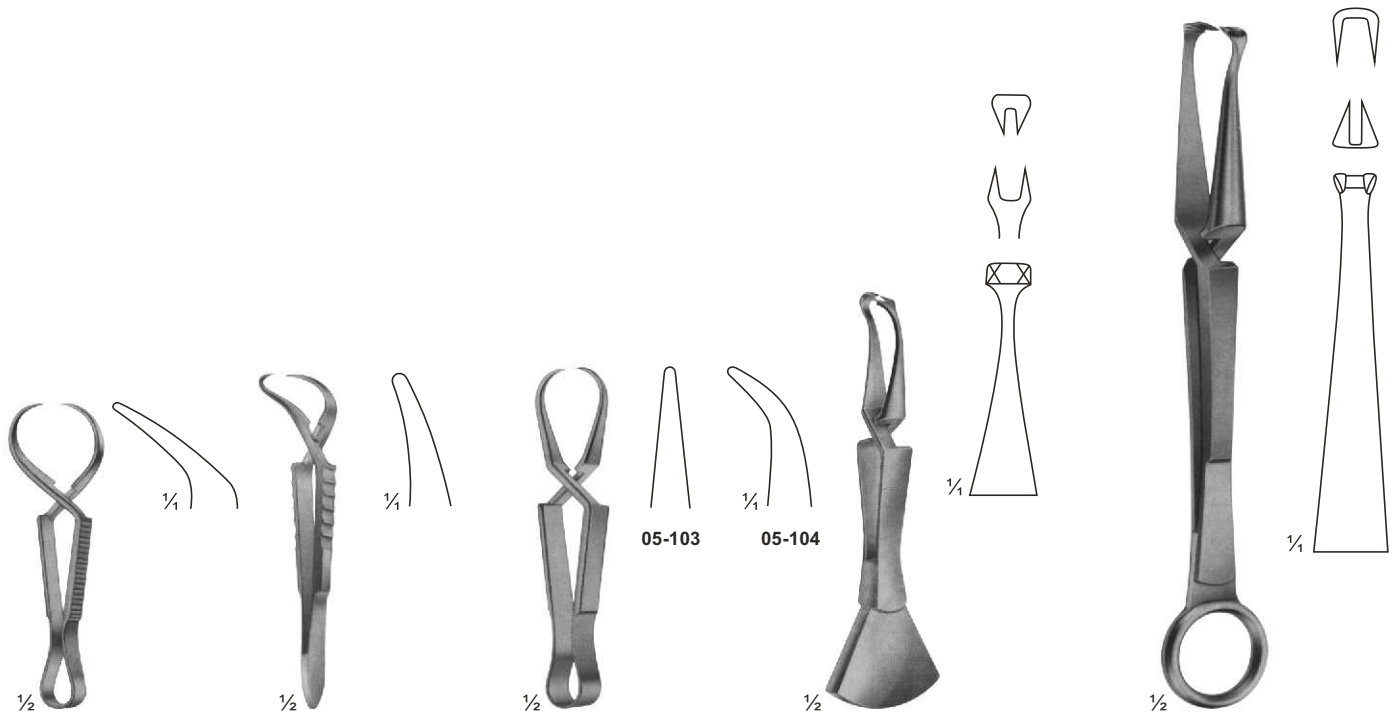

05-101
JONES
85 mm

05-102
ENGL. MOD.
85 mm

05-103 - 104
SCHAEDEL
85 mm

05-105
DOYEN
110 mm

05-106
DOYEN
180 mm

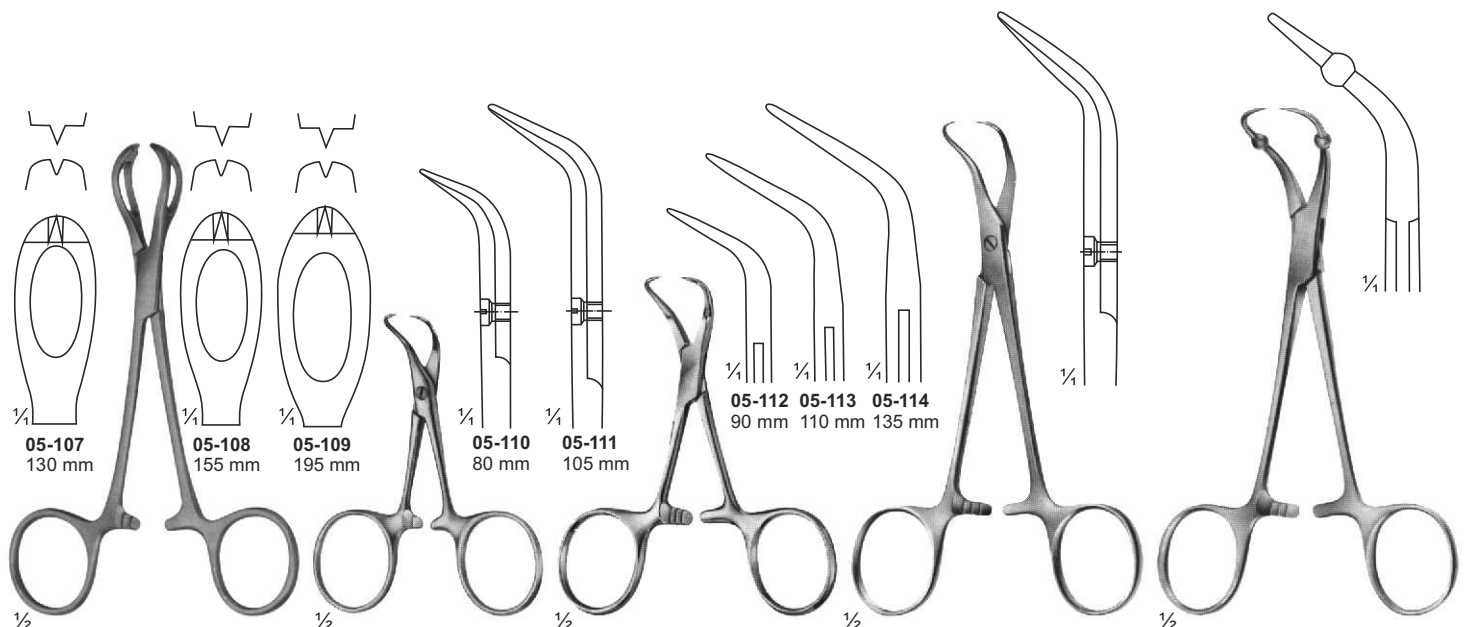

05-107
130 mm

05-108
155 mm

05-109
195 mm

05-110
80 mm

05-111
105 mm

05-112 05-113 05-114
90 mm 110 mm 135 mm

05-107 - 109
LANE

05-110 - 111
BACKHAUS

05-112 - 114
BACKHAUS

05-115
BACKHAUS-KOCHER
135 mm

05-116
ROEDER
135 mm

Towel Clamps

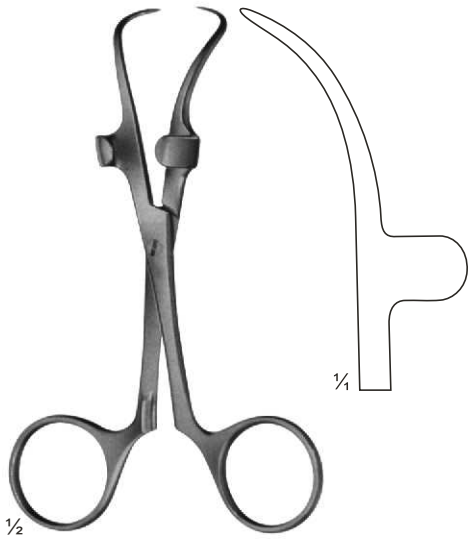

05-117
ROBIN
 with holders for tubing
 up to 13 mm
 135 mm

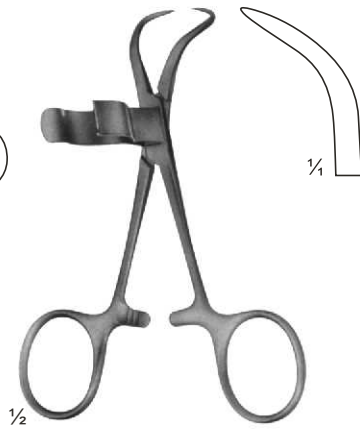

05-118
 with clip for tubing
 up to 15 mm
 110 mm

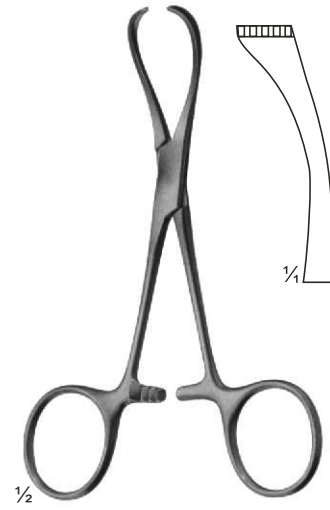

05-119
LORNA
 non perforating
 130 mm

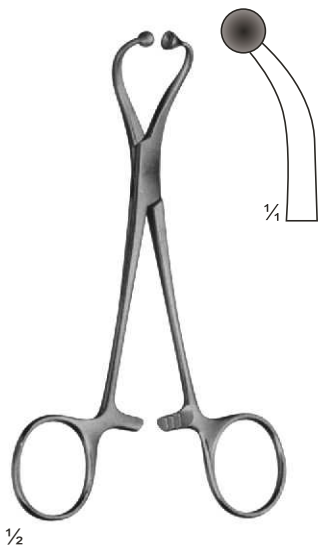

05-120
 for paper cloths
 140 mm



05-121
BUNT
 105 mm



05-122
MAYO
 140 mm

Muller Vessel Clips and Bulldog Clamps

Closing force

1/4
Jaw, cross serrated

05-123 Straight	80g 50g	05-124 Curved	80g 50g	05-125 Curved tips	80g 50g	05-126 Angled Shaped	80g 50g	05-127 Muller Knee-bent	80g 50g	05-128 Muller Ligature Forceps									
05-129 35 mm	05-130 35 mm	05-131 45 mm	05-132 45 mm	05-133 38 mm	05-134 48 mm	05-135 38 mm	05-136 48 mm	05-137 58 mm	05-138 58 mm	05-139 - 145 91 mm	05-146 DE BAKEY-HESS 20 mm								
05-147 Length 50 mm Jaws 27 mm	05-148 Length 48 mm Jaws 27 mm	05-149 GLOVER Length 57 mm Jaws 35 mm	05-150 DE BAKEY Length 73 mm Jaws 38 mm	05-151 DE BAKEY Length 99 mm Jaws 63 mm	05-152 DE BAKEY Length 95 mm Jaws 54 mm	05-153 L. 80 mm	05-154 L. 90 mm	05-155 L. 105 mm	05-156 L. 124 mm	05-157 L. 78 mm	05-158 L. 86 mm	05-159 L. 97 mm	05-160 L. 114 mm	05-161 GLOVER L. 68 mm	05-162 L. 96 mm	05-163 L. 117 mm	05-164 GLOVER L. 65 mm	05-165 L. 91 mm	05-166 L. 110 mm

Delicate Haemostatic Forceps

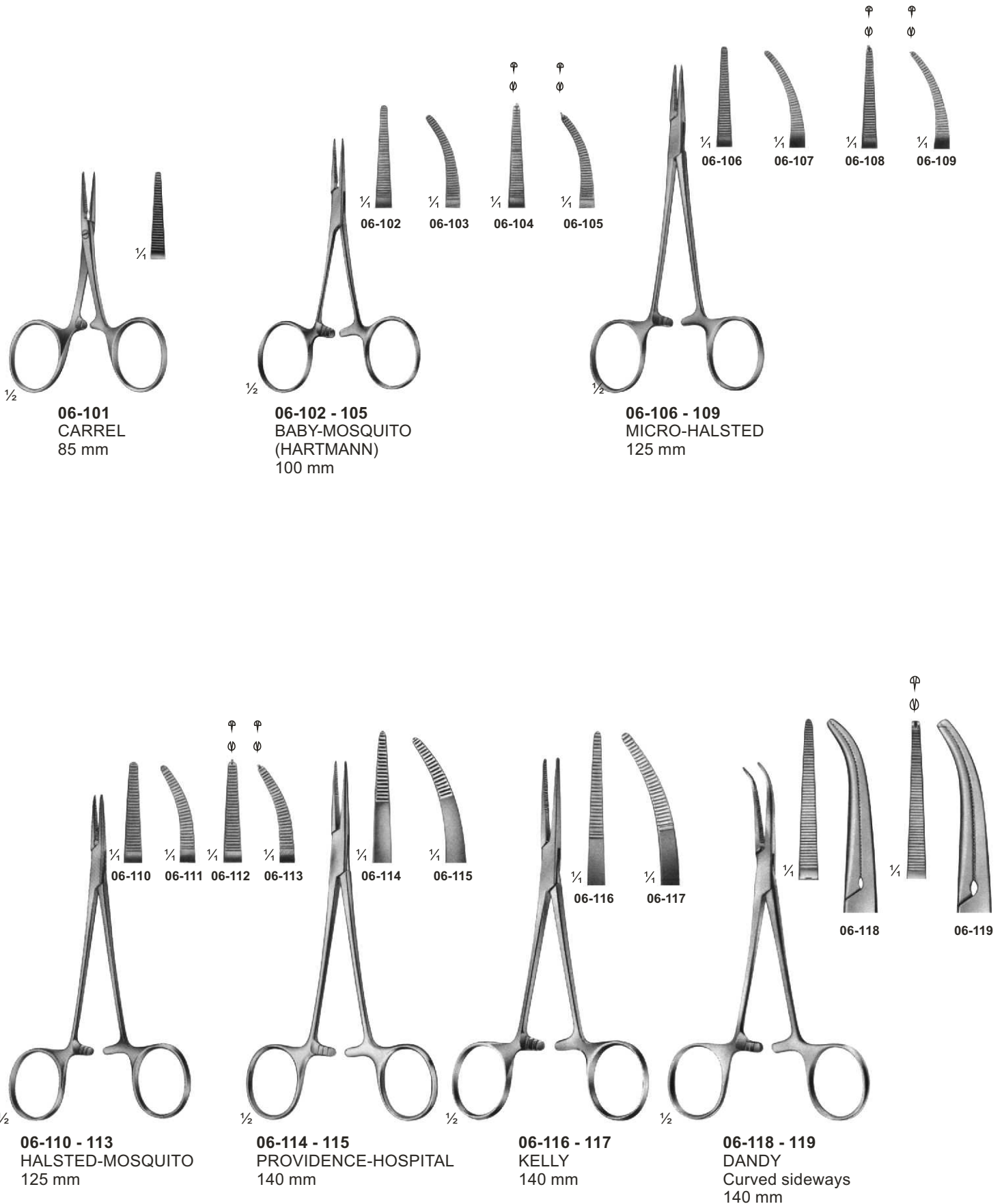

Delicate Haemostatic Forceps

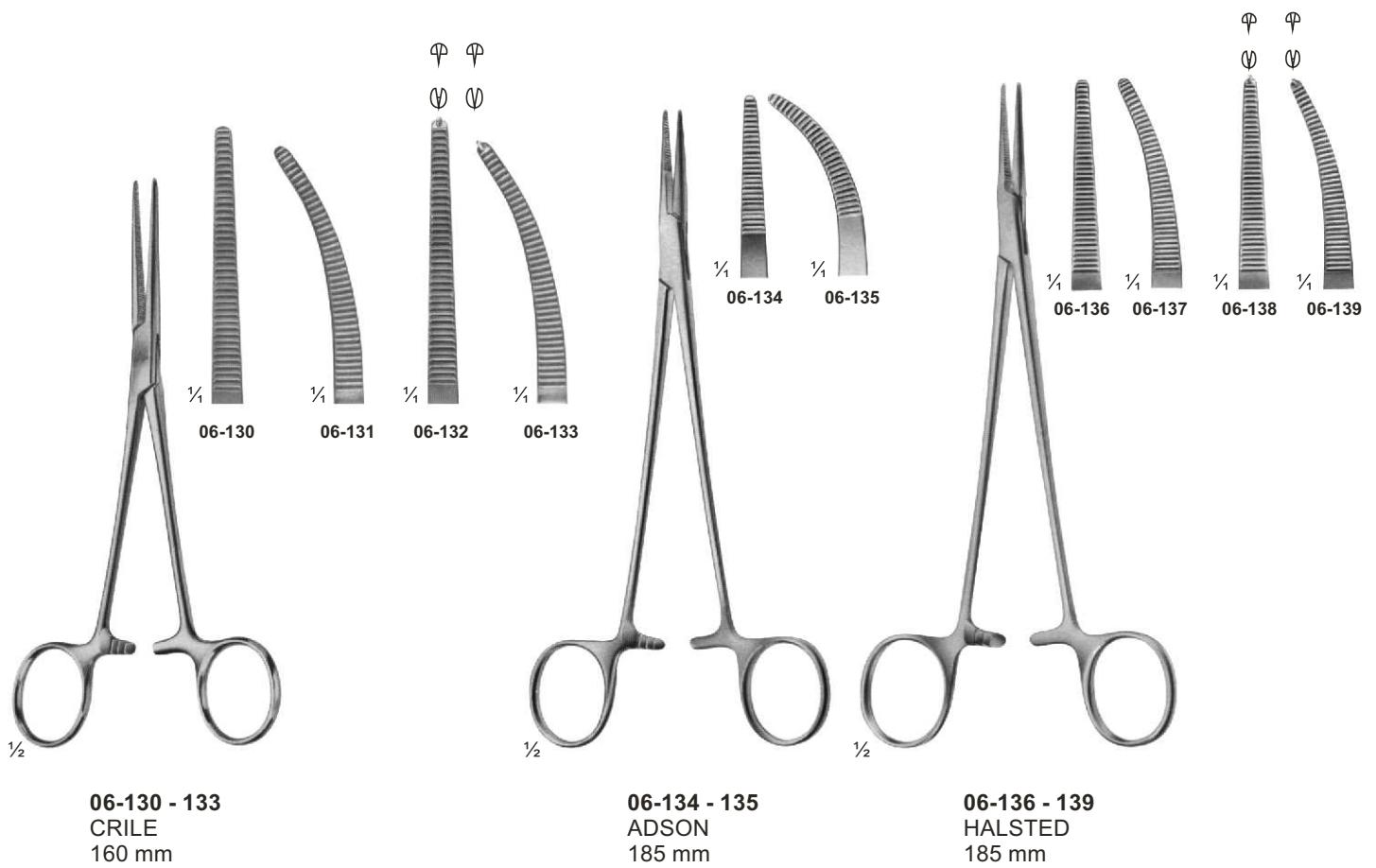
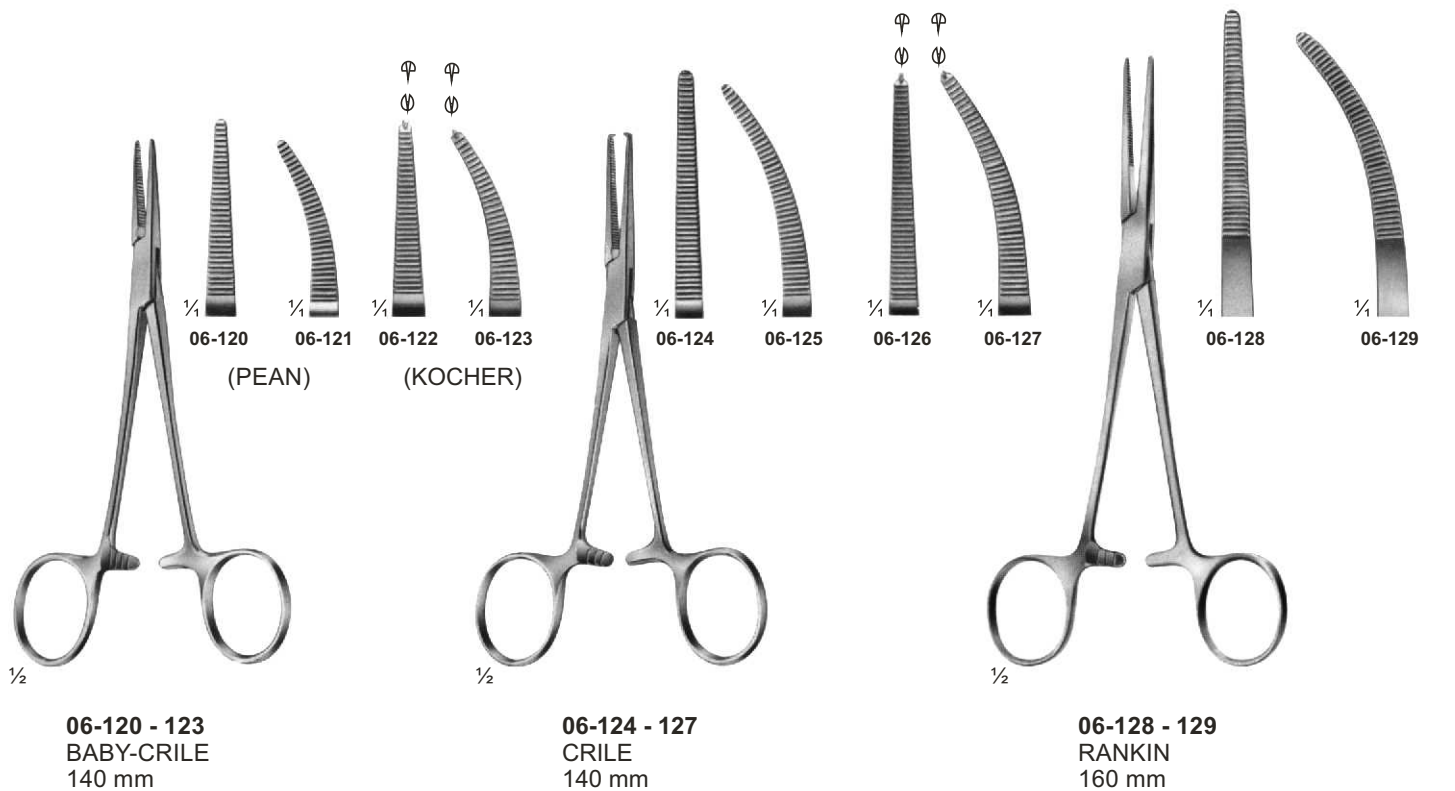

Delicate Haemostatic Forceps

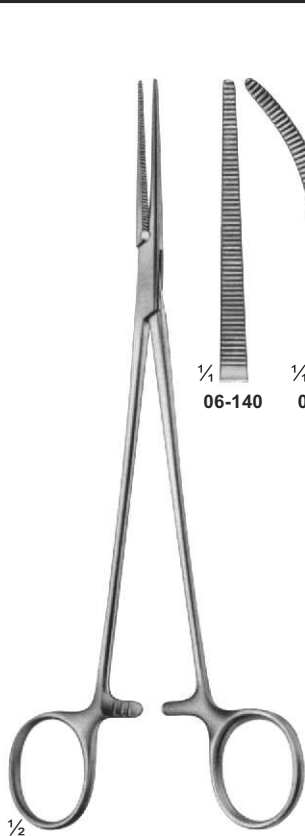

06-140 - 143
HALSTED-MOSQUITO
200 mm

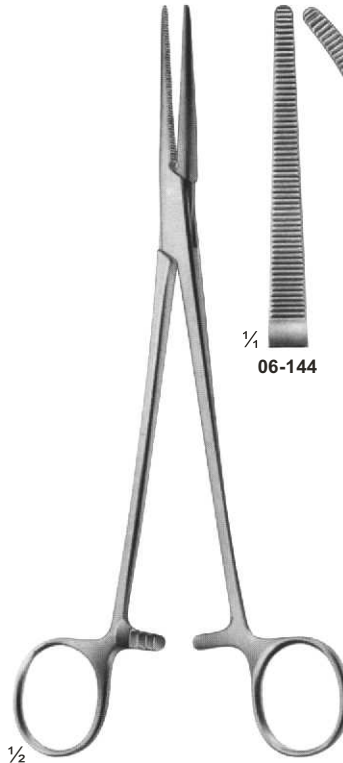
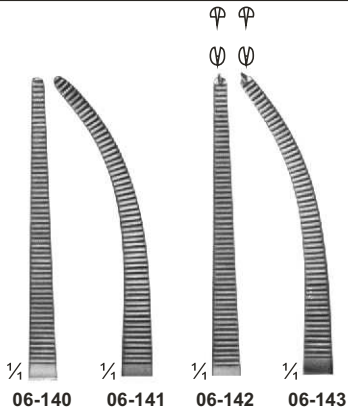

06-144 - 148
HEISS
200 mm

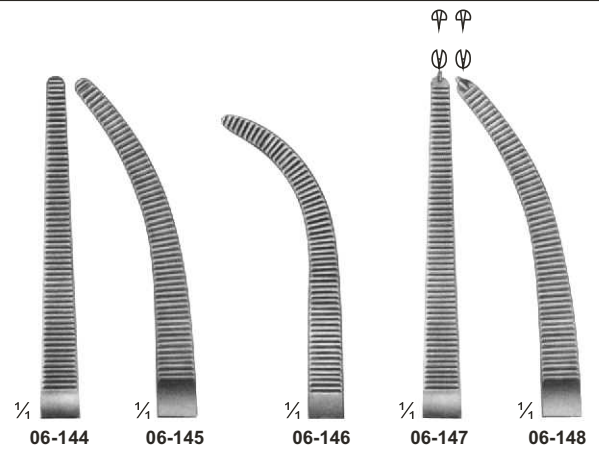

06-149 - 150
HALSTED
215 mm

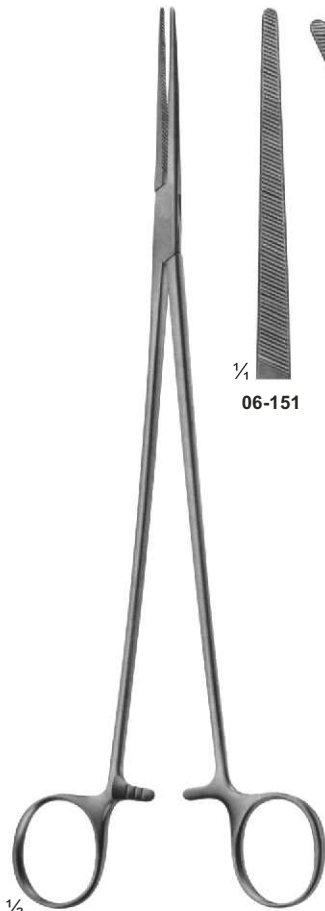

06-151 - 154
BENGOLEA
245 mm

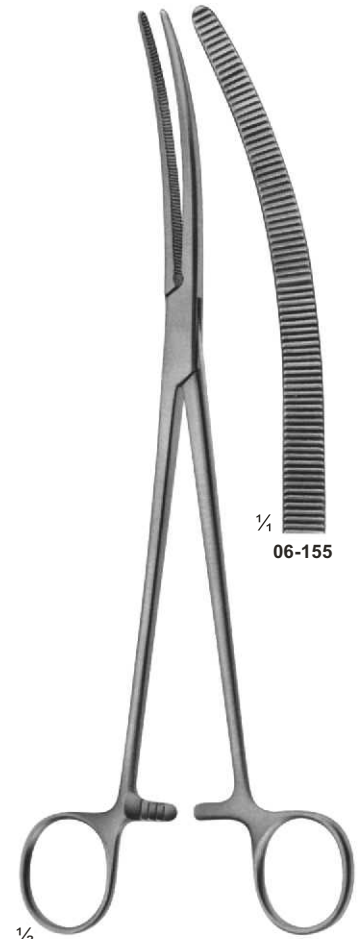
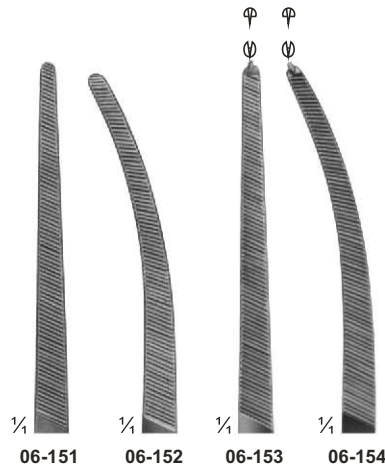

06-155
CRAFOORD
245 mm



Haemostatic Forceps

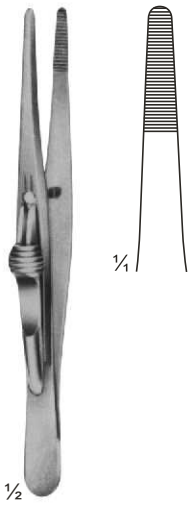

06-156
FRICKE
Artery forceps
130 mm

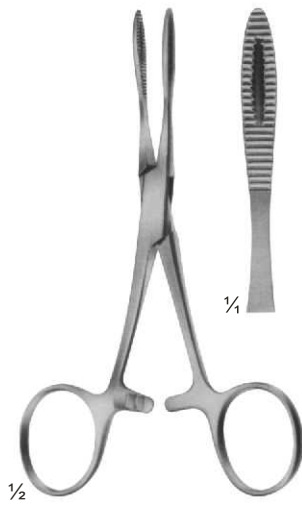

06-157
KRONLEIN
130 mm

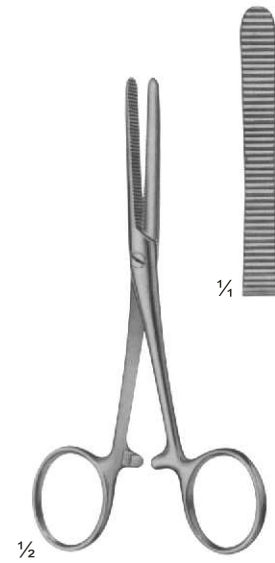

06-158
PEAN
125 mm



06-159 - 160
PEAN

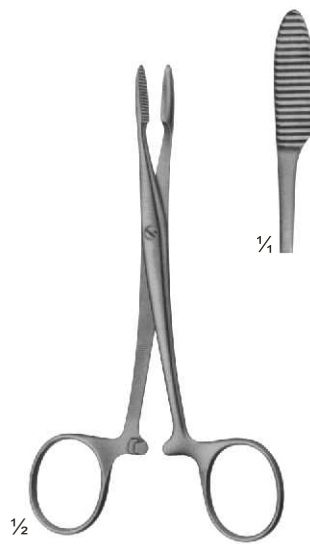

06-161
PEAN

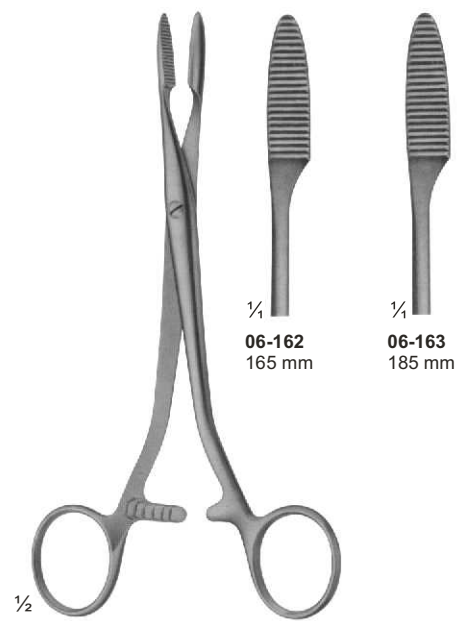

06-162 - 163
PEAN

Haemostatic Forceps

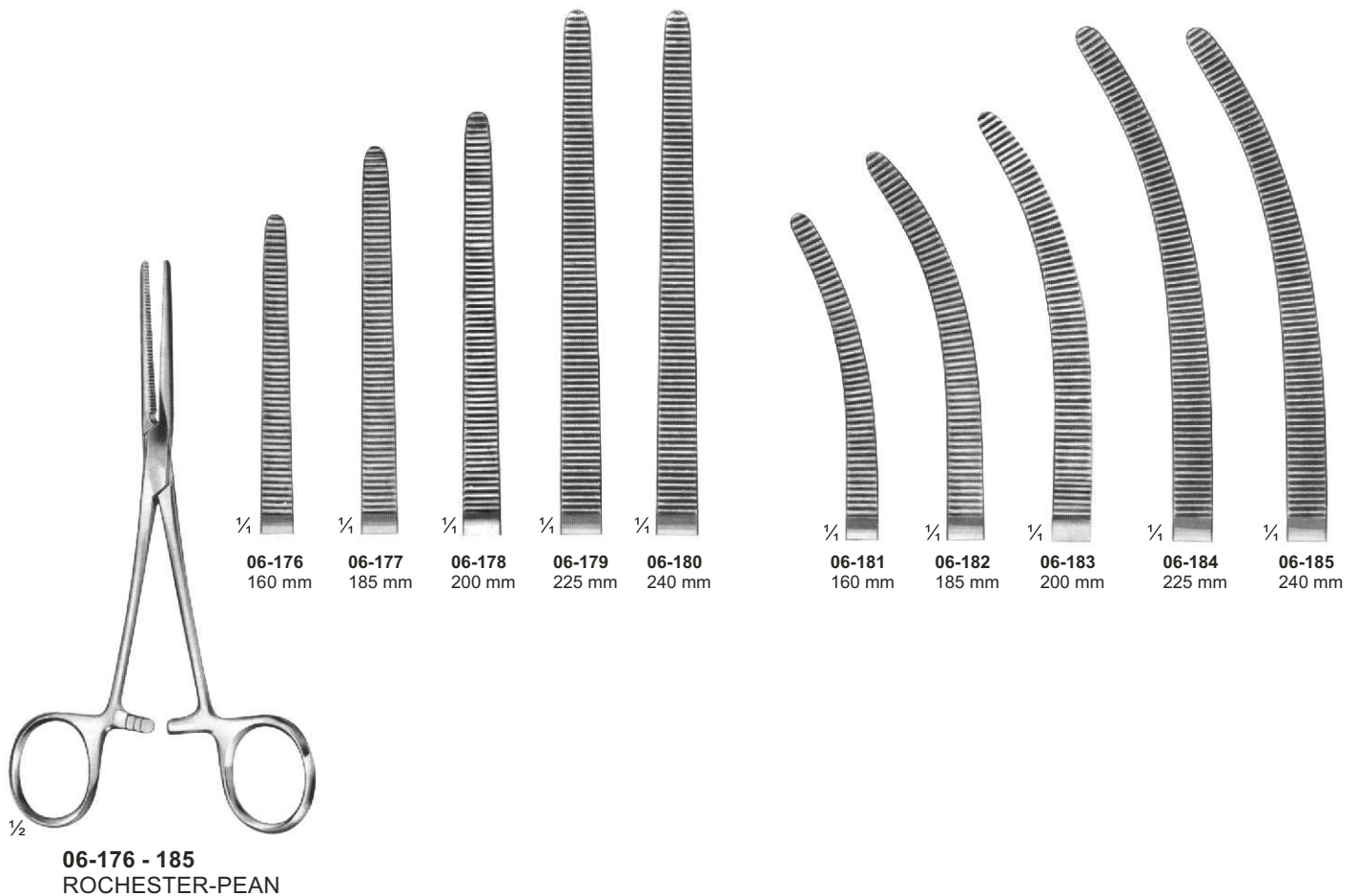
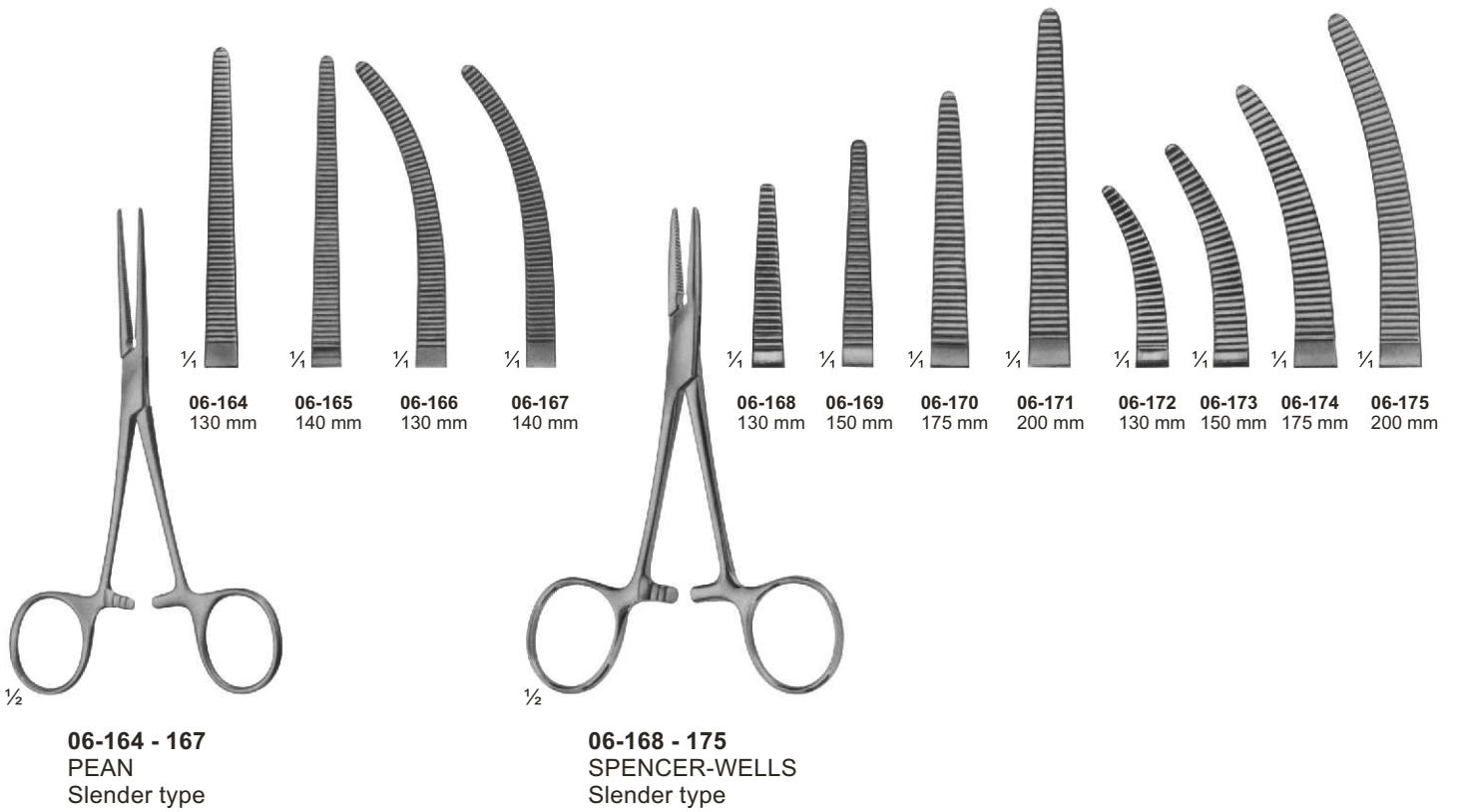

Haemostatic Forceps

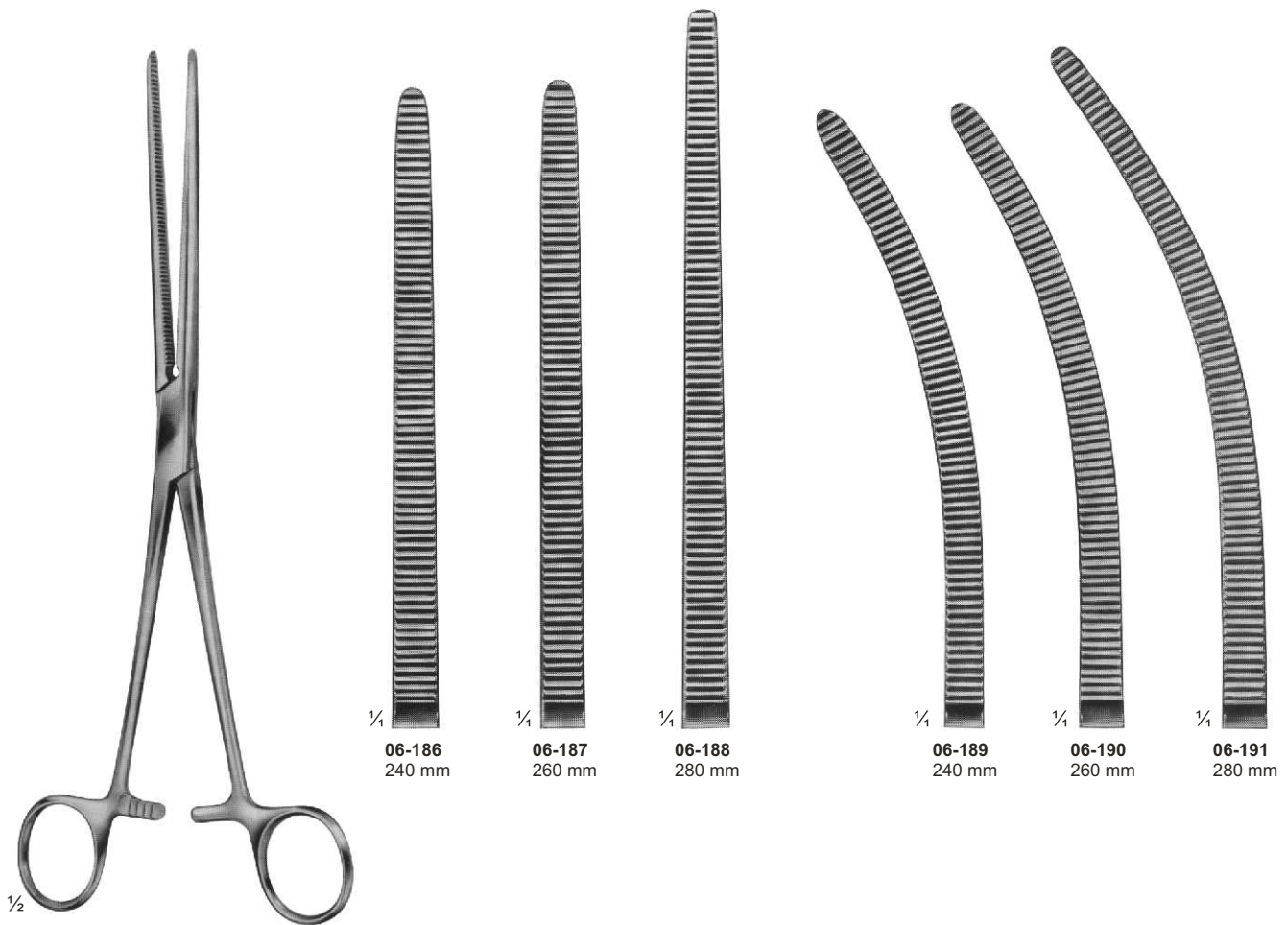

06-186 - 191
PEAN

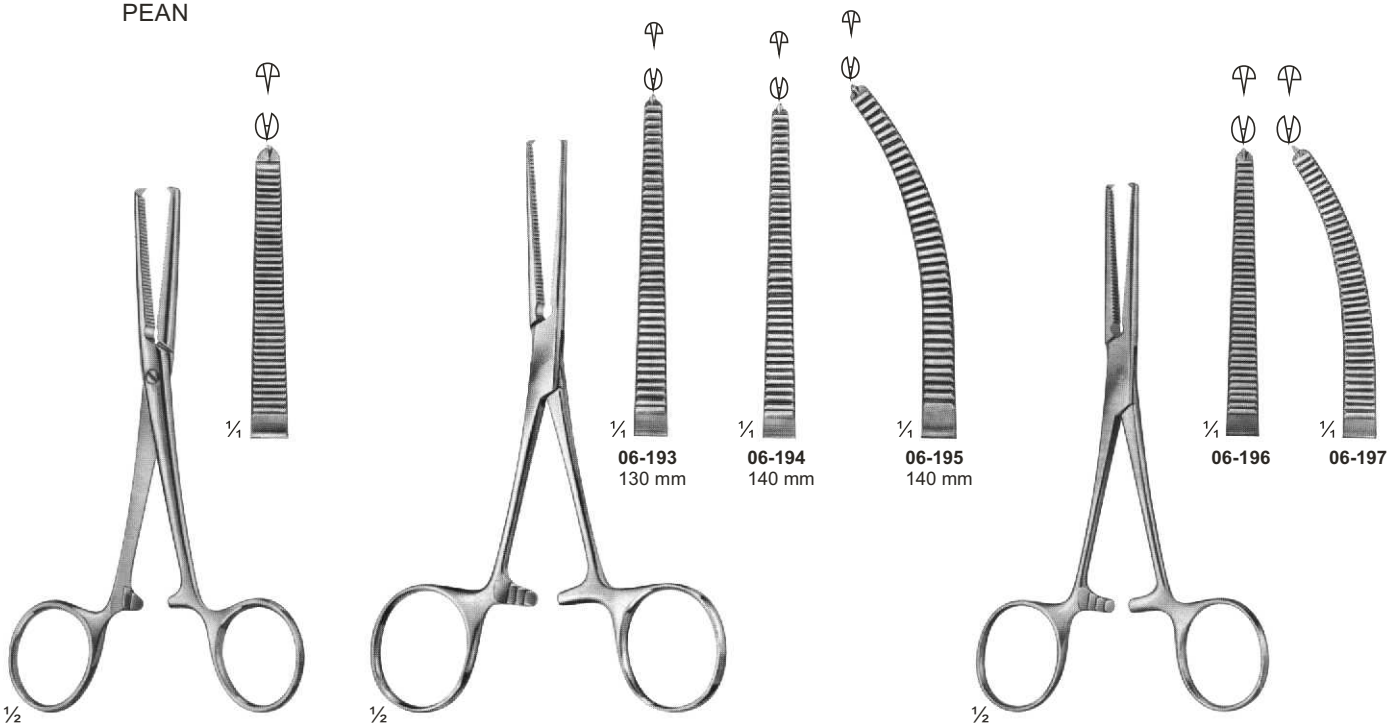

06-192
KOCHER
Strong Pattern
145 mm

06-193 - 195
KOCHER

06-196 - 197
ROCHESTER-OSHSNER
140 mm

Haemostatic Forceps

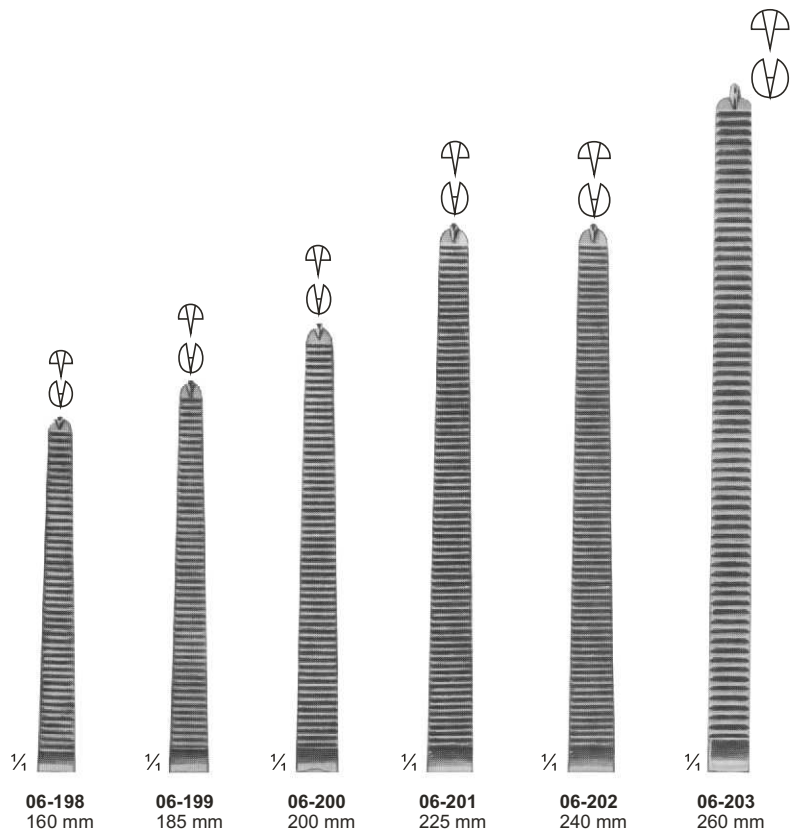

06-198 - 209
KOCHER-OCHSNER

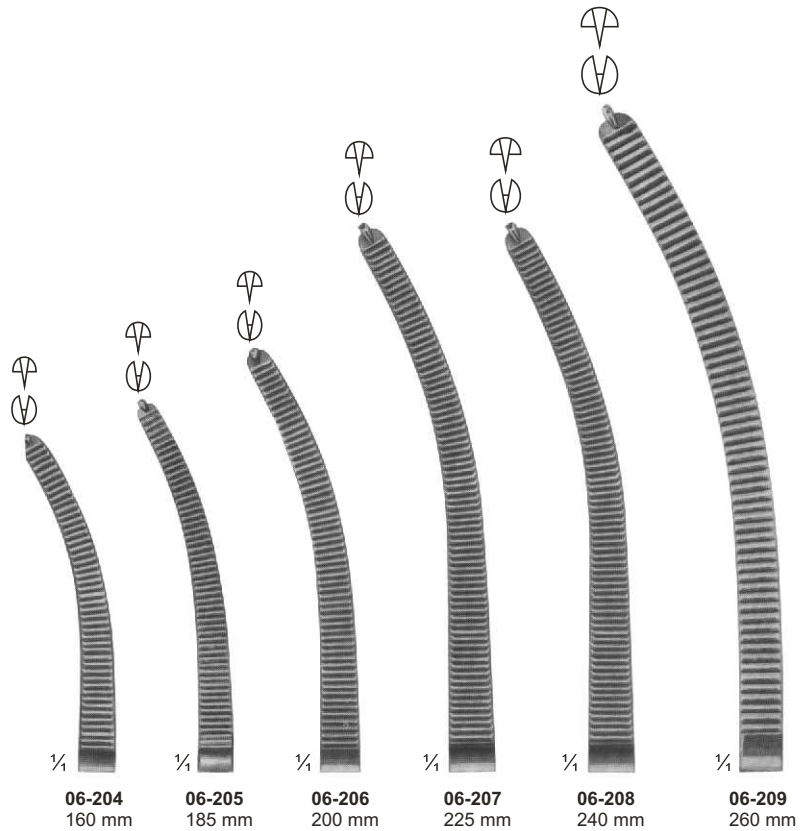

Haemostatic Forceps, Special Pattern, Tonsil Forceps

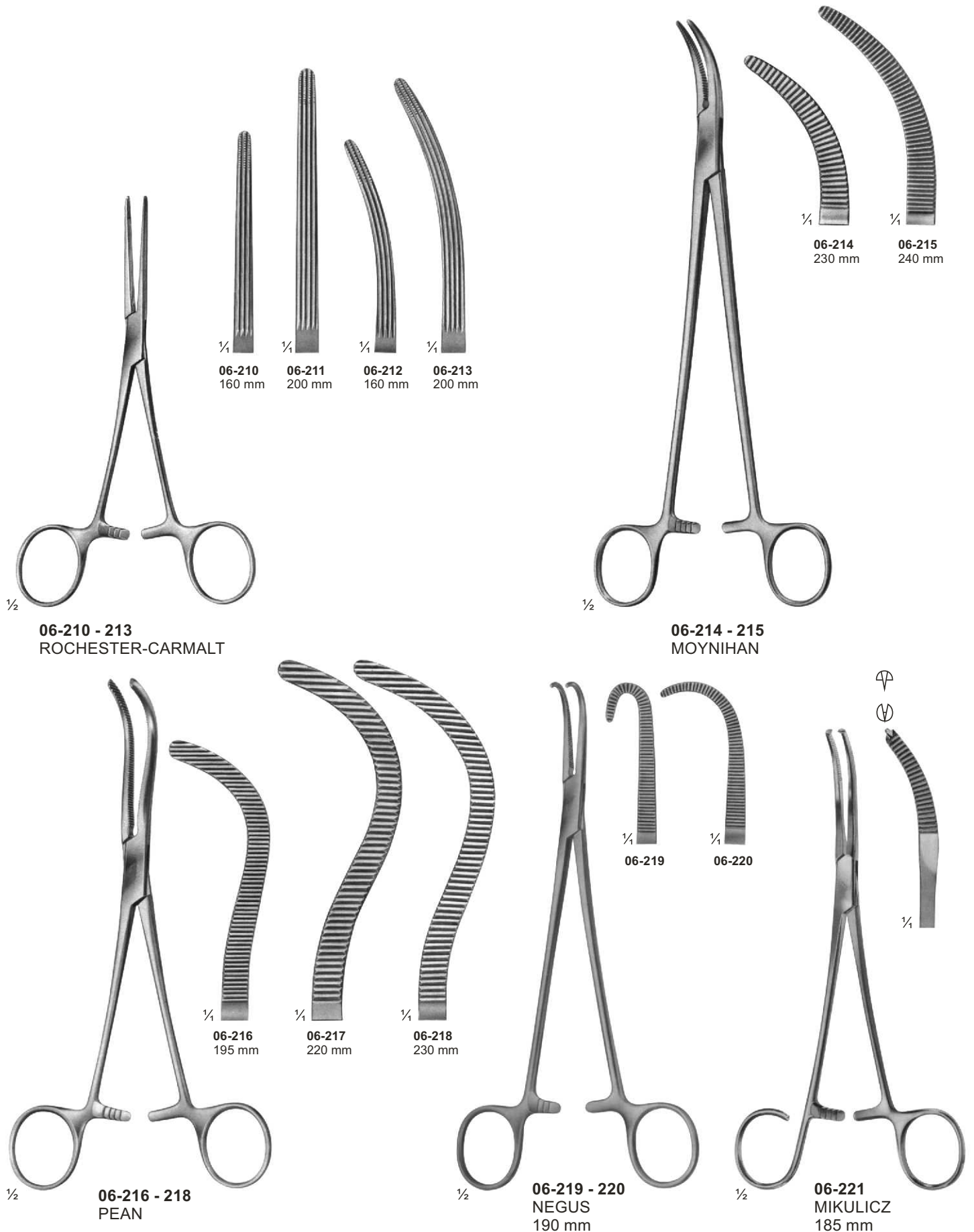

Dissecting- and Ligature Forceps

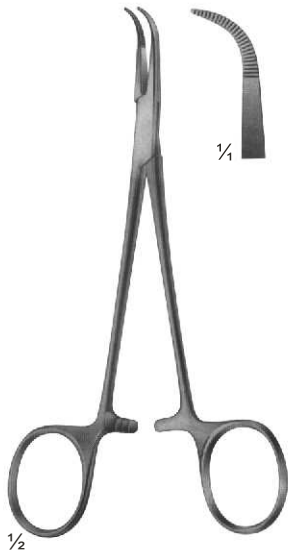

06-222
MICRO-ADSON
140 mm

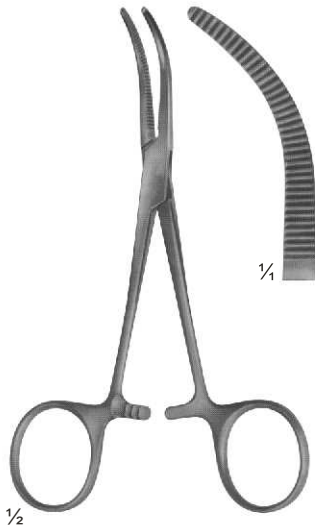

06-223
BABY-OVERHOLT
135 mm



06-224 - 225
BABY-MIXTER

06-224
140 mm

06-225
180 mm



06-226 - 227
BABY-ADSON

06-226
140 mm

06-227
180 mm

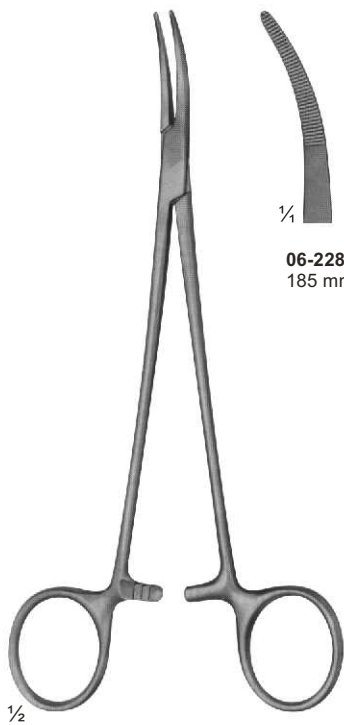

06-228
NISSEN

06-228
185 mm



06-229 - 230
YASARGIL
195 mm

06-229

06-230

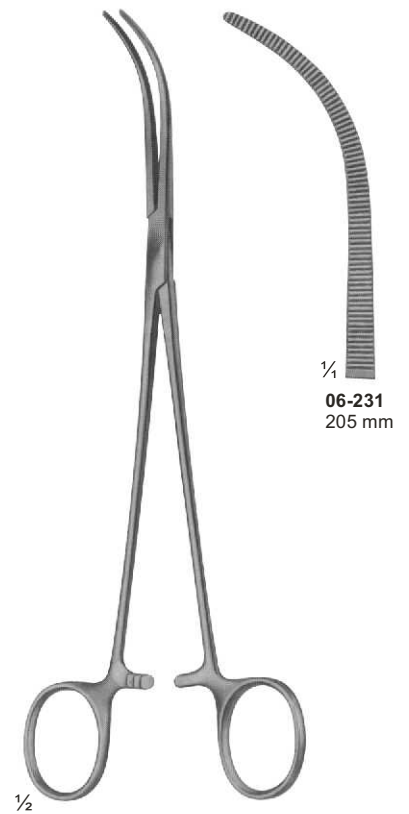

06-231
OVERHOLT-MIXTER

06-231
205 mm

Dissecting- and Ligature Forceps

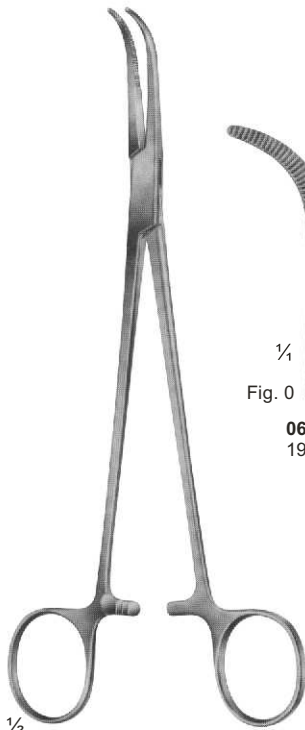

1/2

06-232 - 243
OVERHOLT-GEISSENDOERFER

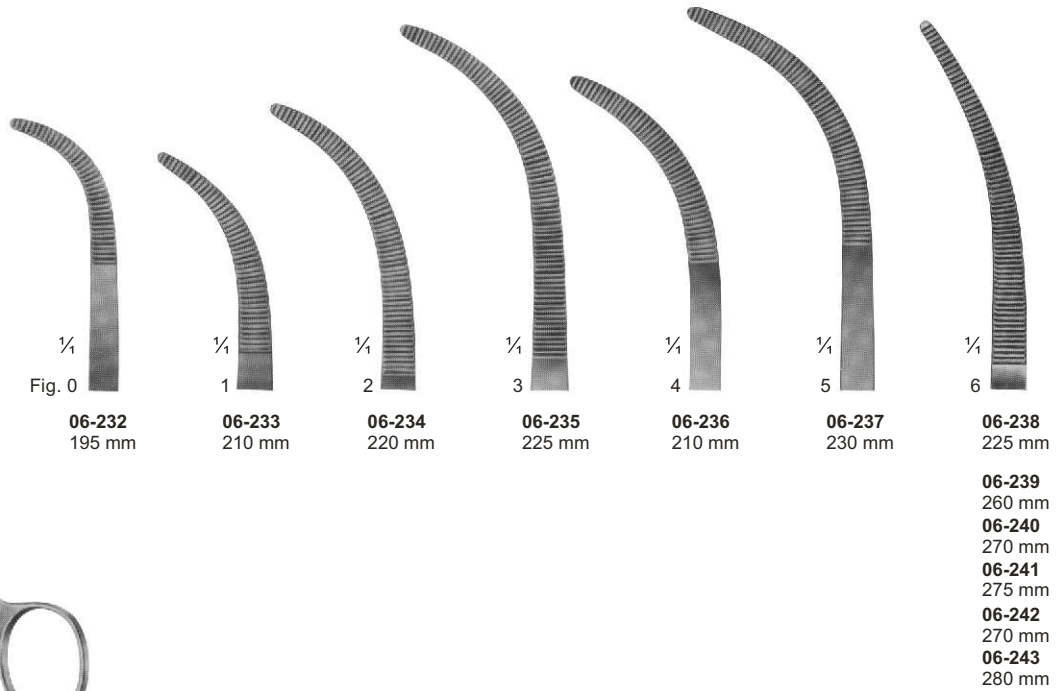

06-239 260 mm
06-240 270 mm
06-241 275 mm
06-242 270 mm
06-243 280 mm

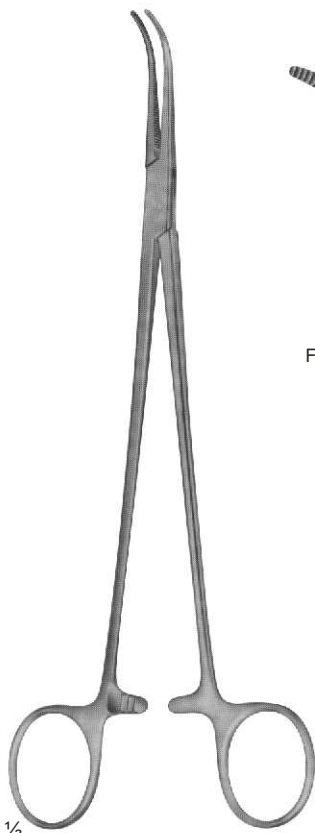

1/2

06-244 - 251
OVERHOLT
fine pattern

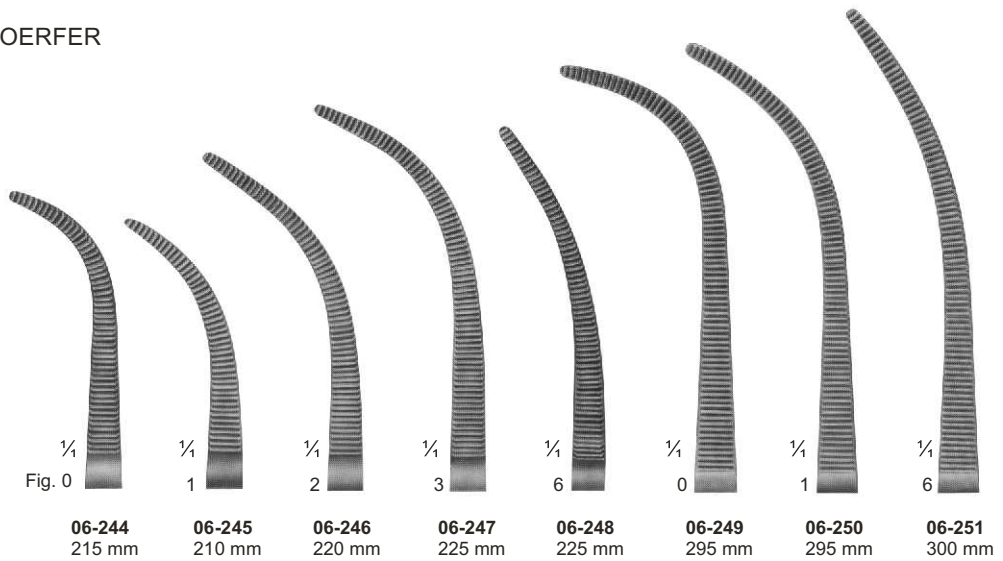

Dissecting- and Ligature Forceps

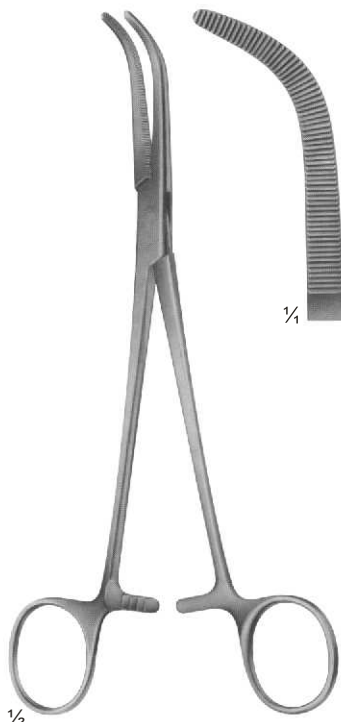

06-252
MIXTER-O'SHAUGHNESSY
190 mm

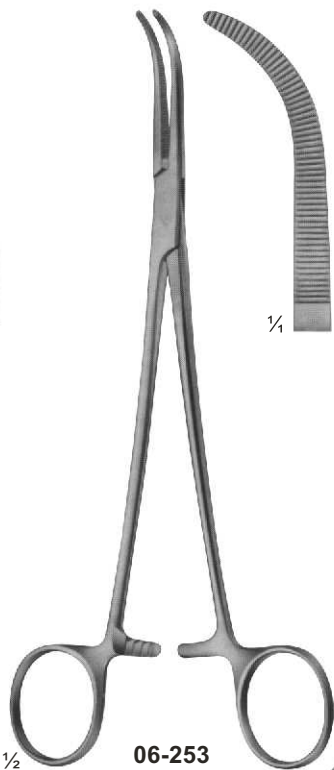

06-253
HEISS
195 mm

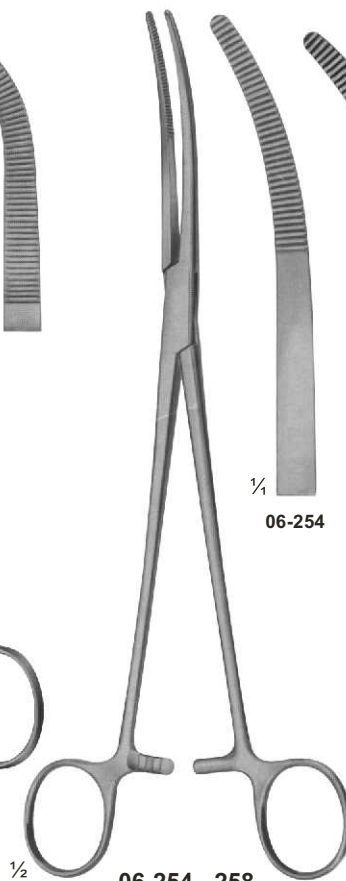

06-254 - 258
RUMEL
240 mm

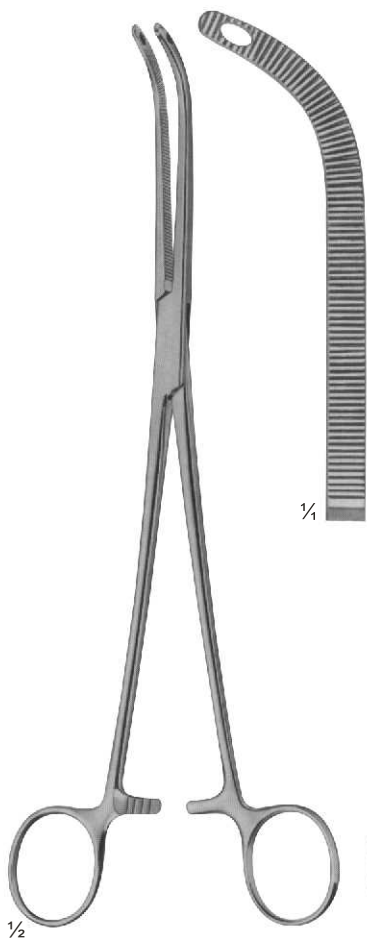
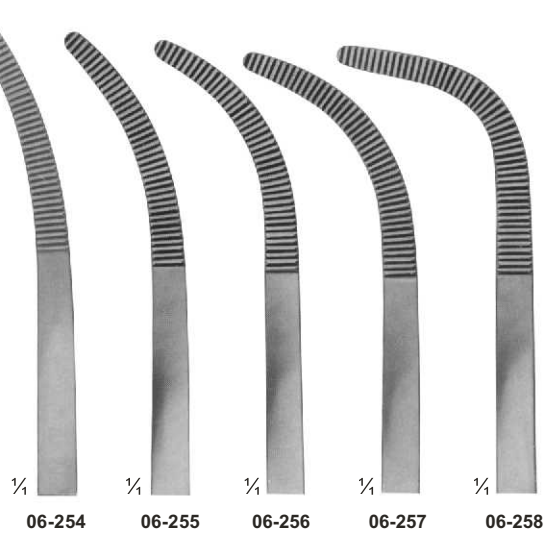

06-259
FINOCHIETTO
245 mm

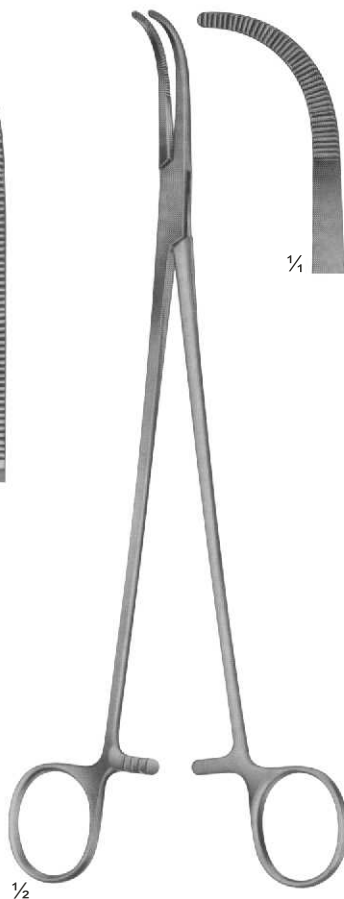

06-260
MIXTER
230 mm



06-261
LAWRENCE
270 mm

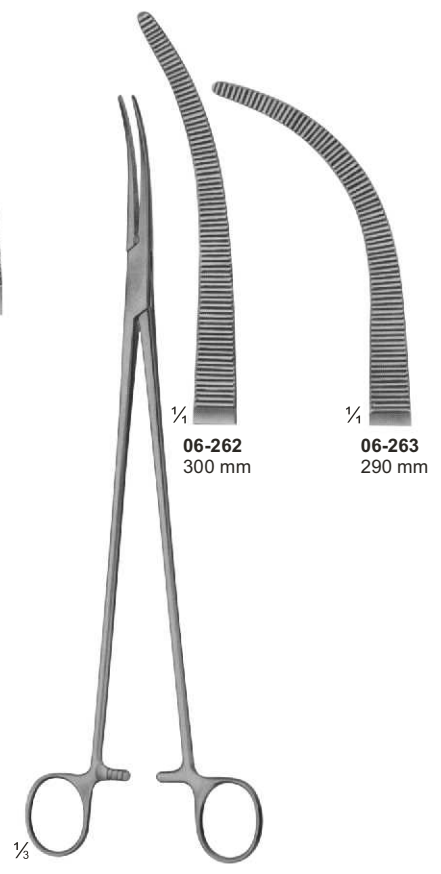

06-262 - 263
ZENKER

Dissecting- and Ligature Forceps

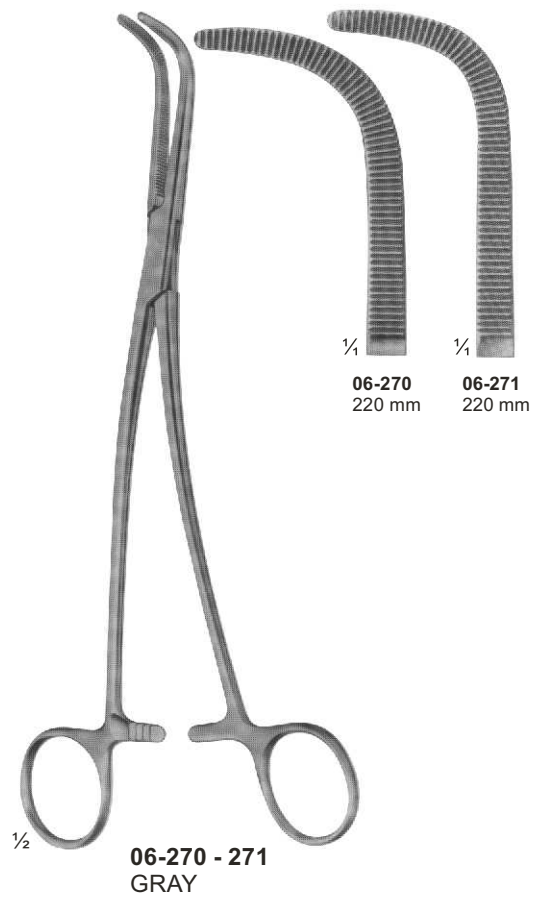
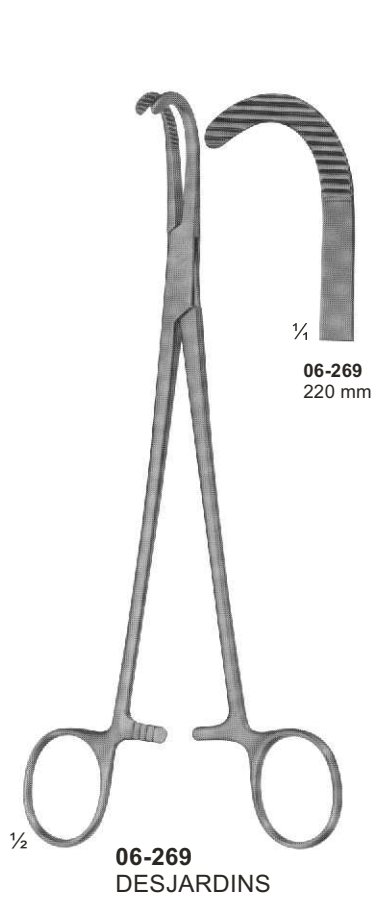

Peritoneum Forceps

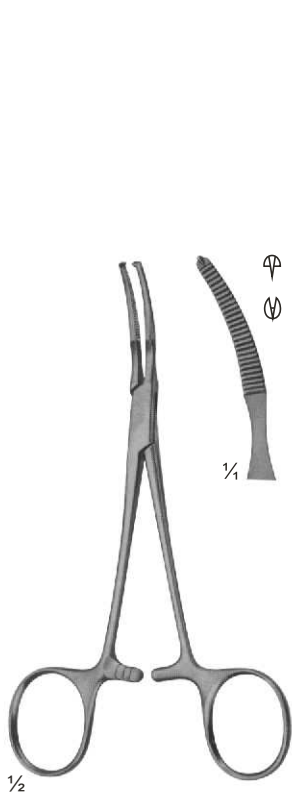

06-272
BABY-MIKULICZ
140 mm

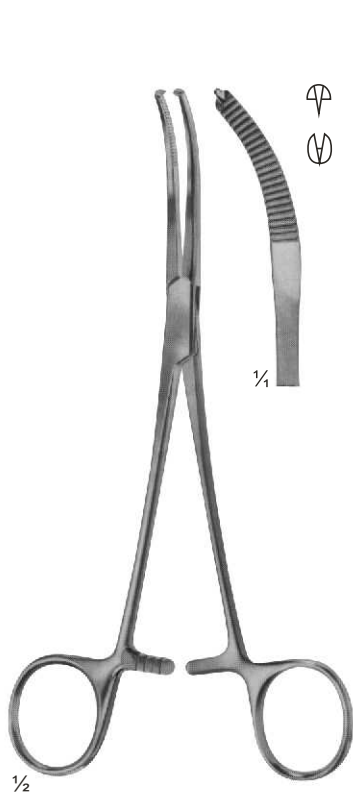

06-273
MIKULICZ
185 mm

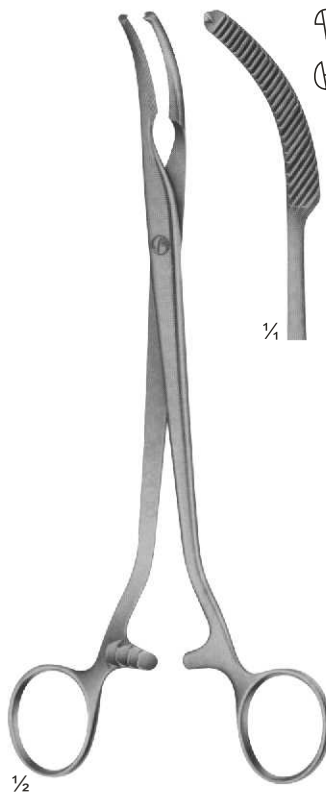

06-274
MIKULICZ
205 mm

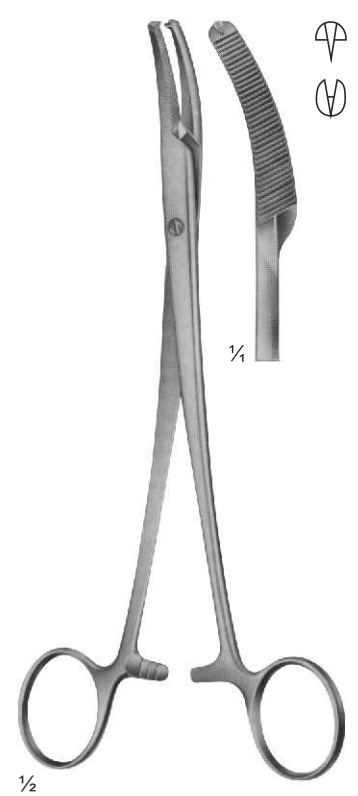

06-275
MIKULICZ
200 mm

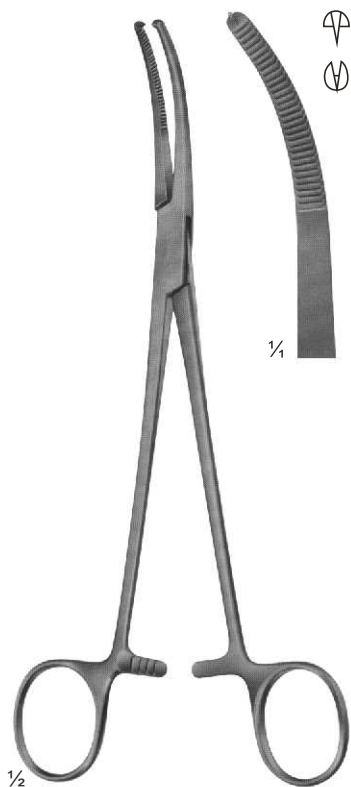

06-276
MIKULICZ
205 mm

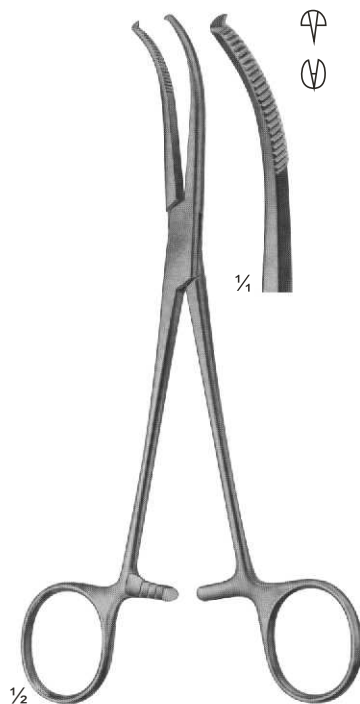

06-277
MIKULICZ
185 mm

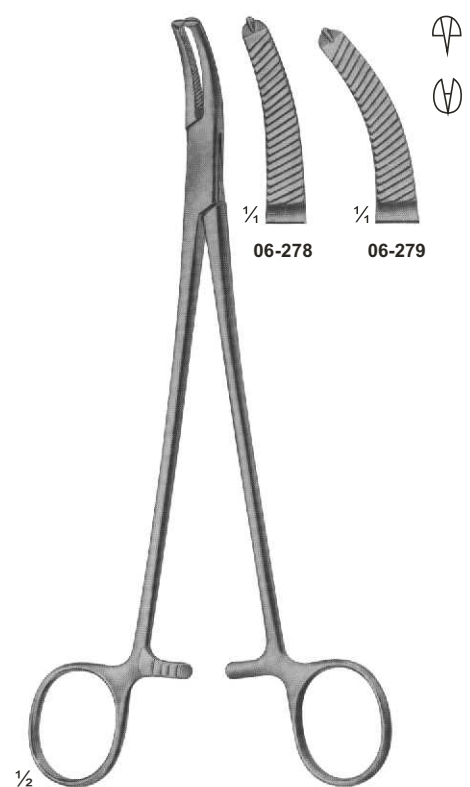

06-278 - 279
FAURE
205 mm

Hysterectomy Forceps

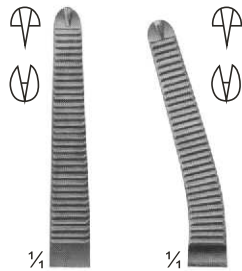
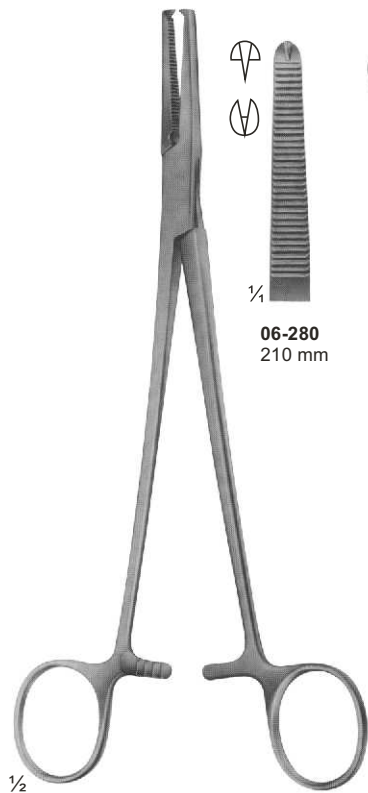

06-280
210 mm

06-281
205 mm

$\frac{1}{2}$
06-280 - 281
PHANEUF

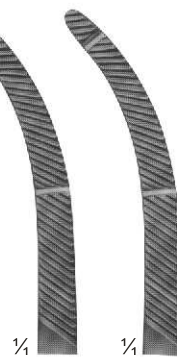

06-282
205 mm

06-283
245 mm

$\frac{1}{2}$
06-282 - 283
HEANEY modif.

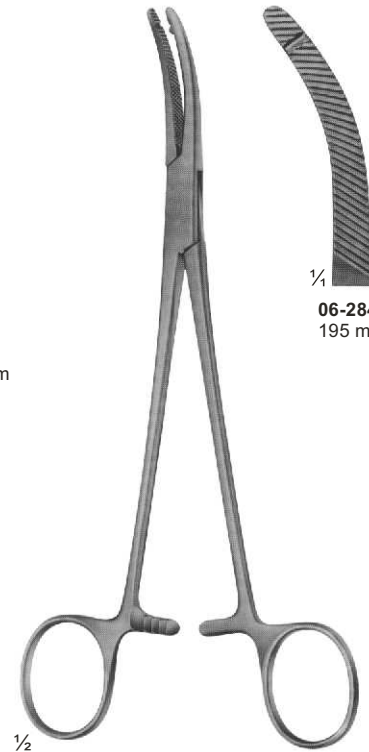

06-284
195 mm

$\frac{1}{2}$
06-284
HEANEY

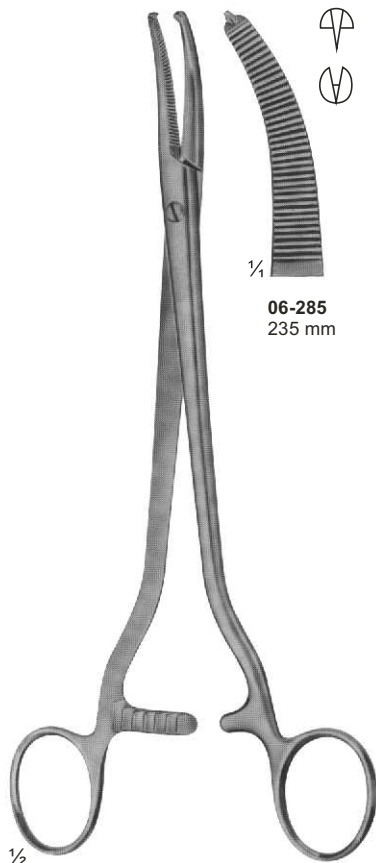

06-285
235 mm

$\frac{1}{2}$
06-285
WERTHEIM

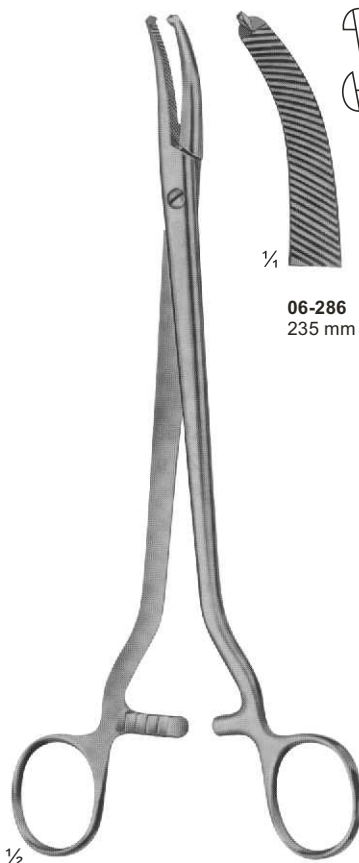

06-286
235 mm

$\frac{1}{2}$
06-286
WERTHEIM

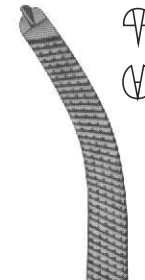
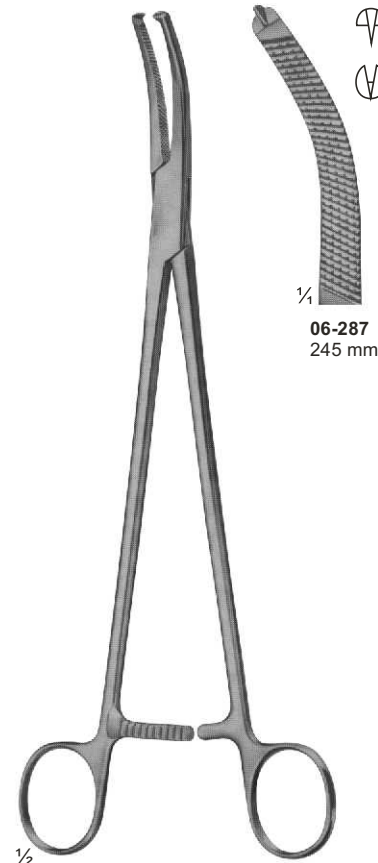

06-287
245 mm

$\frac{1}{2}$
06-287
WERTHEIM

Hysterectomy Forceps and Vaginal Clamps



06-288
225 mm



06-289
220 mm



06-290
215 mm

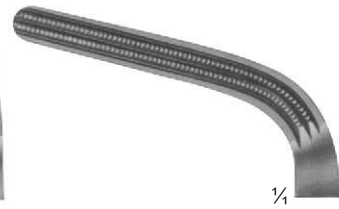

06-291
205 mm

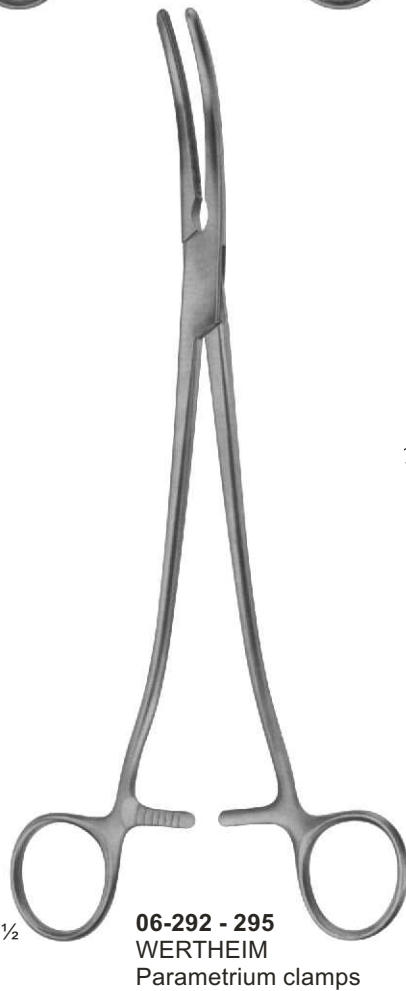

06-292
250 mm



06-293
245 mm



06-294
240 mm

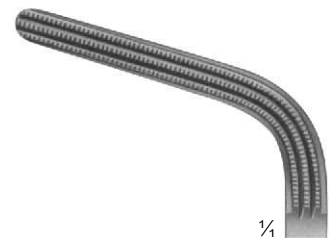

06-295
220 mm

Hysterectomy Forceps and Vaginal Clamps and Compression Forceps

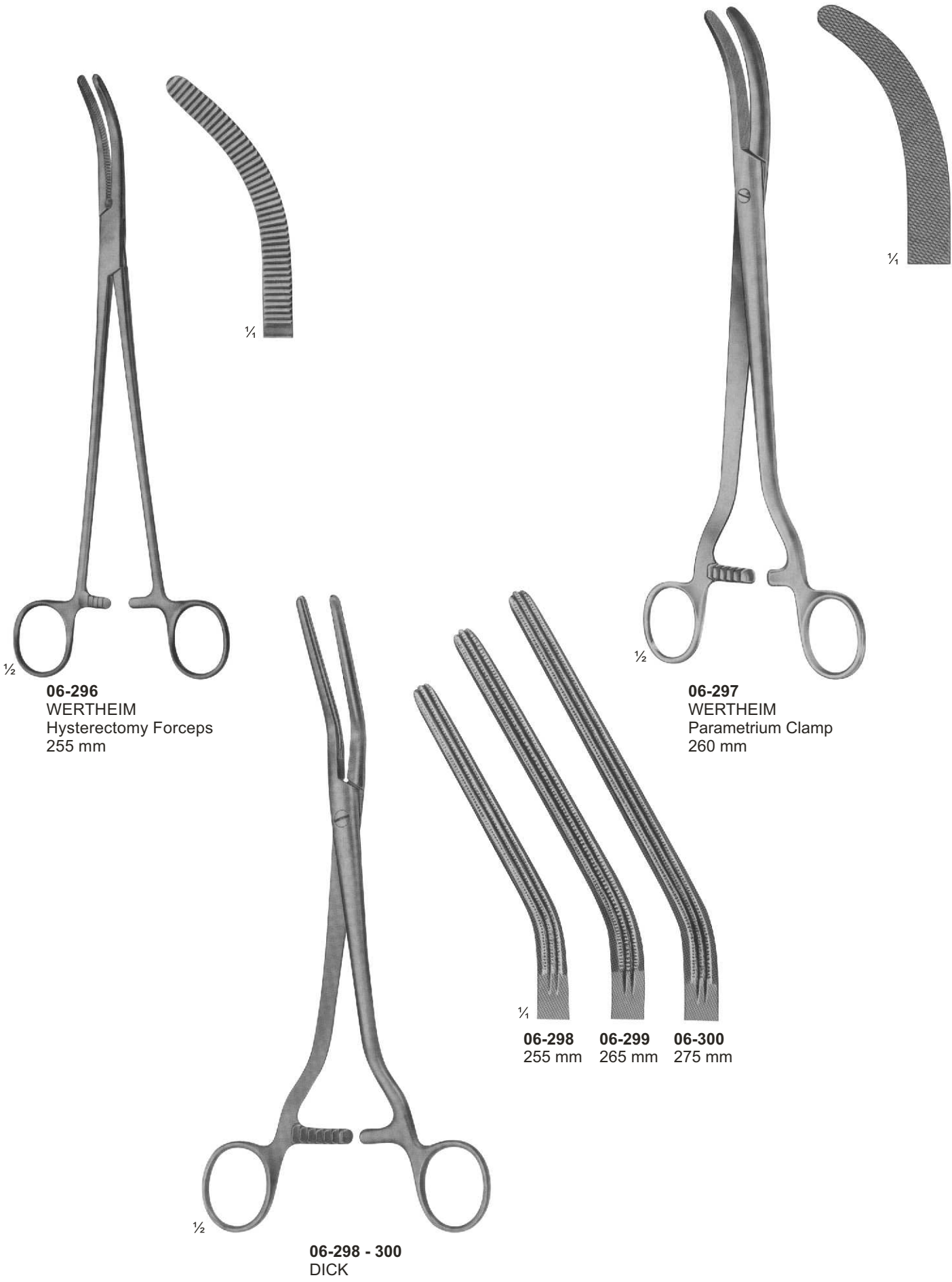

1/2
06-296
WERTHEIM
 Hysterectomy Forceps
 255 mm

1/2
06-297
WERTHEIM
 Parametrium Clamp
 260 mm

1/2
06-298 - 300
DICK

1/4
06-298 255 mm
06-299 265 mm
06-300 275 mm

Hysterectomy Forceps and Vaginal Clamps and Compression Forceps

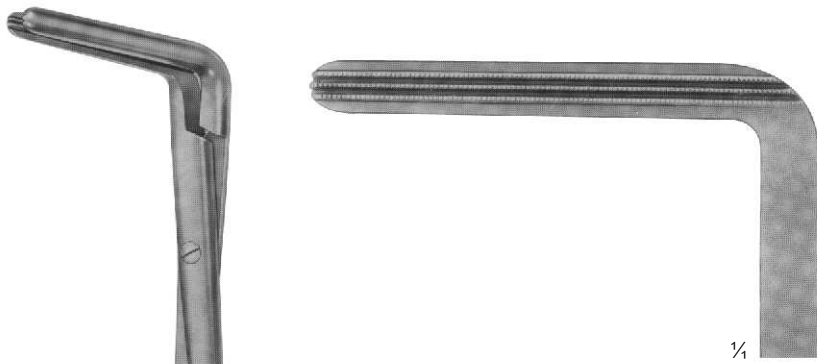

06-301
WERTHEIM
250 mm

1/2

1/4

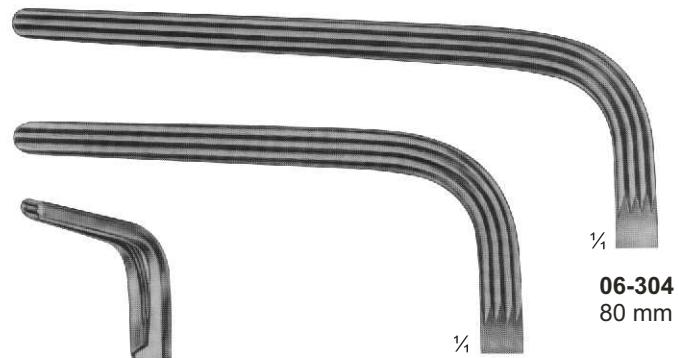

1/4

06-304
80 mm

1/4

06-303
60 mm



1/4

1/2

06-302
WERTHEIM-CULLEN
215 mm



1/2

06-303 - 304
230 mm

Needle Holders For Micro Surgery



07-101
ROHRSCHEIDER
With copper inserts
100 mm



07-102
KALT
With catch
135 mm



07-103
ARRUGA
With catch
135 mm



07-104 - 105
CASTROVIEJO
With catch
145 mm



07-106 - 107
CASTROVIEJO
With Catch
160 mm

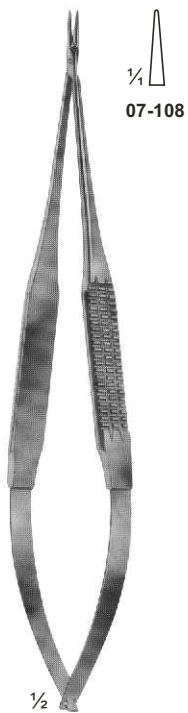

07-108 - 109
Without catch
185 mm



07-110 - 111
JACOBSON
185 mm



07-112
Without catch
195 mm



07-113 - 114
YASARGIL
With catch
200 mm

Micro Needle Holders With Round Handles



07-115 116
BARRAQUER
Without catch



07-117 - 118
BARRAQUER
Without catch
120 mm



07-119 - 120
BARRAQUER
With catch
120 mm



07-121 - 122
BARRAQUER
With Catch
150 mm



07-123
MULLER
With Locking
Mechanism
145 mm



07-124 - 125
BROCK
Without catch
150 mm



07-126 - 127
YASARGIL
200 mm



07-128 - 129
YASARGIL
225 mm



07-130
YASARGIL
245 mm

Needle Holders



07-131
CONVERSE
125 mm



Smooth jaws

07-132
WEBSTER
125 mm

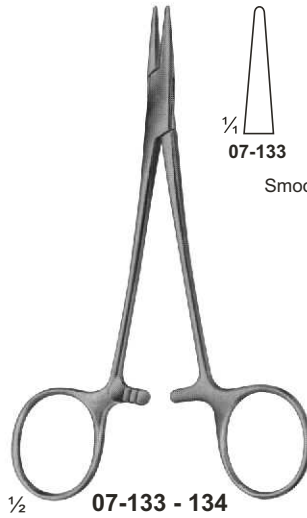

07-133 **07-134**
Smooth jaws

07-133 - 134
HALSEY
130 mm



07-135
DERF
130 mm

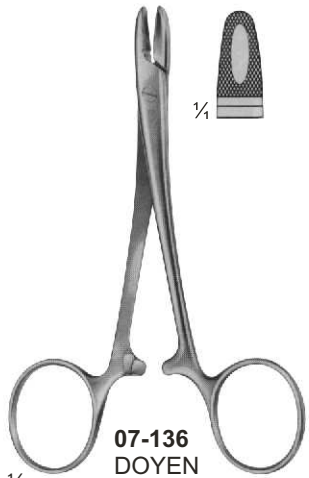

07-136
DOYEN
125 mm



07-137
BAUMGARTNER
145 mm

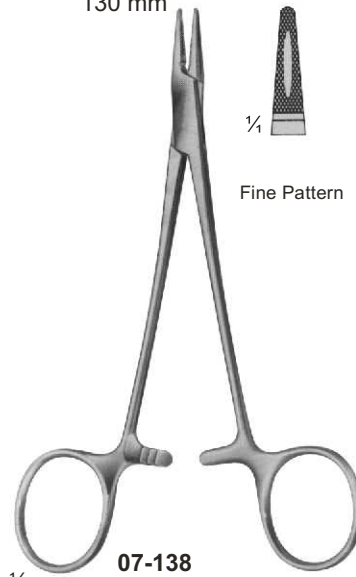

Fine Pattern

07-138
CRILE-WOOD
150 mm

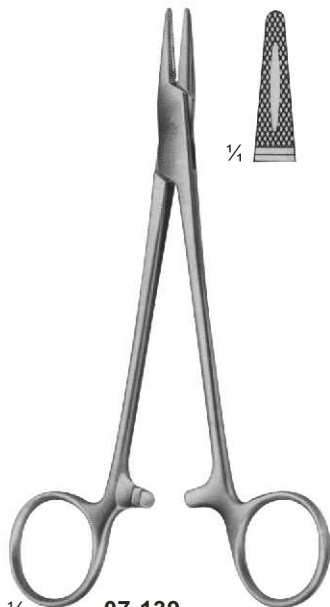

07-139
CRILE-WOOD
160 mm

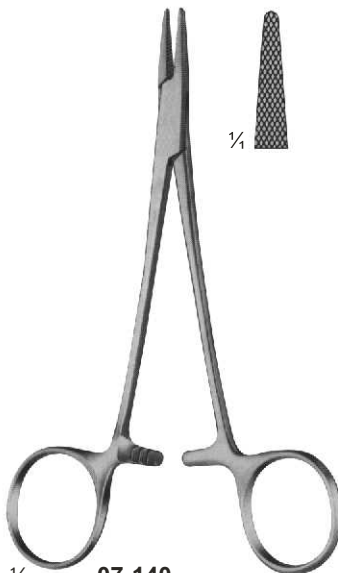

07-140
CRILE-MURRAY
150 mm

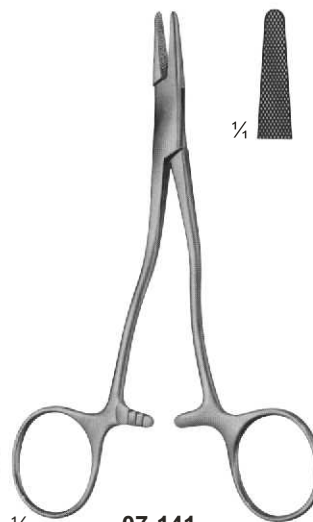

07-141
KILNER
135 mm



07-142
ADSON
175 mm

Needle Holders

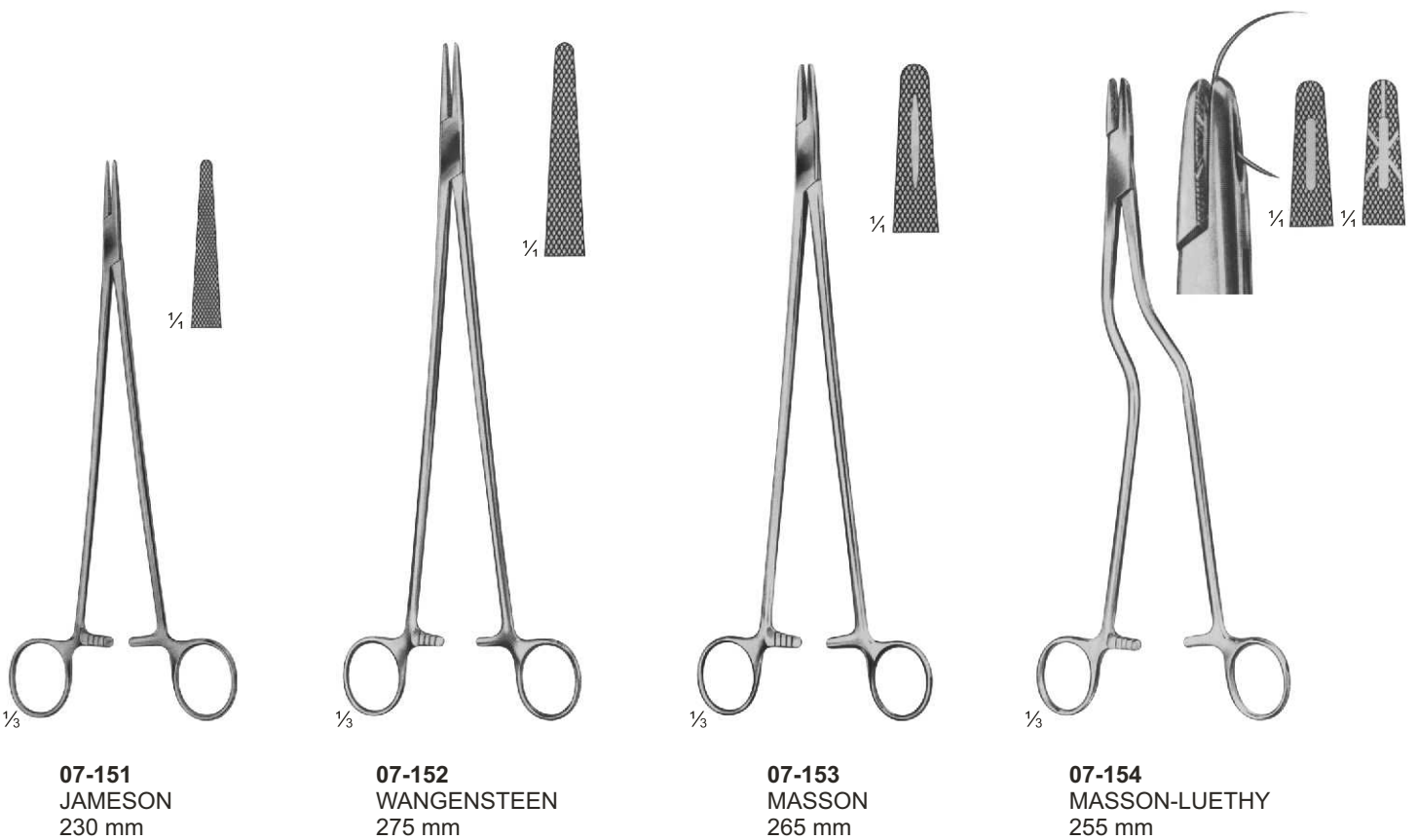

Needle Holders

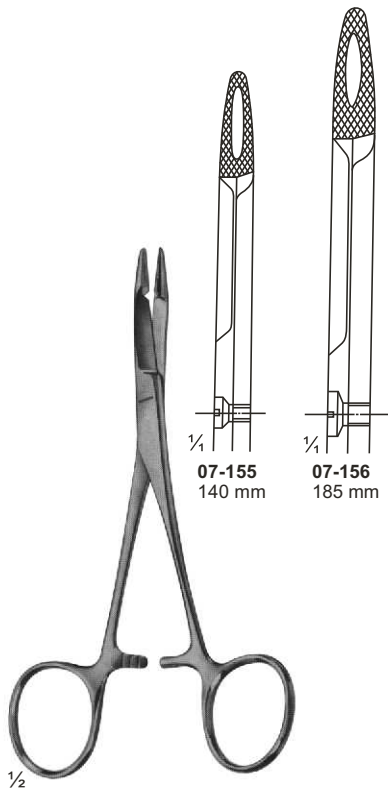

07-155 - 156
HEGAR-OLSEN
255 mm

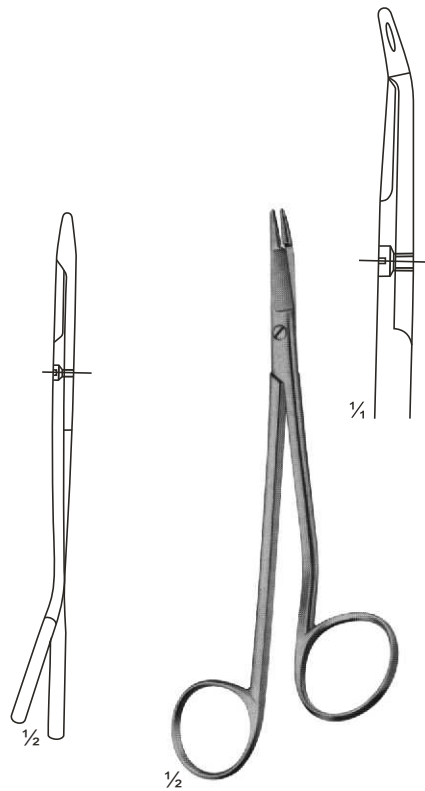

07-157
GILLIES
150 mm

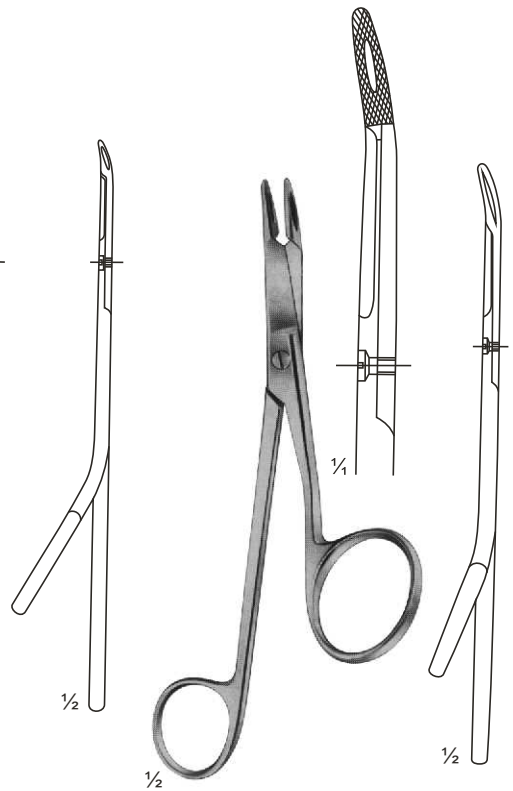

07-158
GILLIES
160 mm

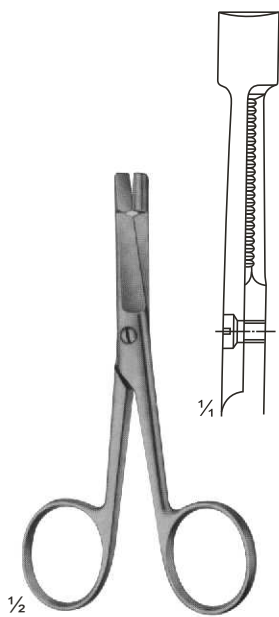

07-159
EISELSBERG
115 mm

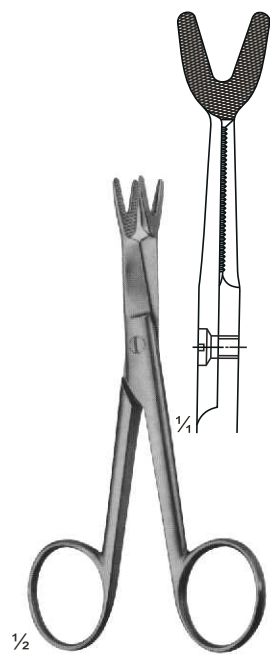

07-160
SCHOEMAKER-LOTH
125 mm



07-161
CRILE
150 mm



07-162
TONNIS
Elastic pattern for
dura-or intestinal suture
180 mm

Needle Holders

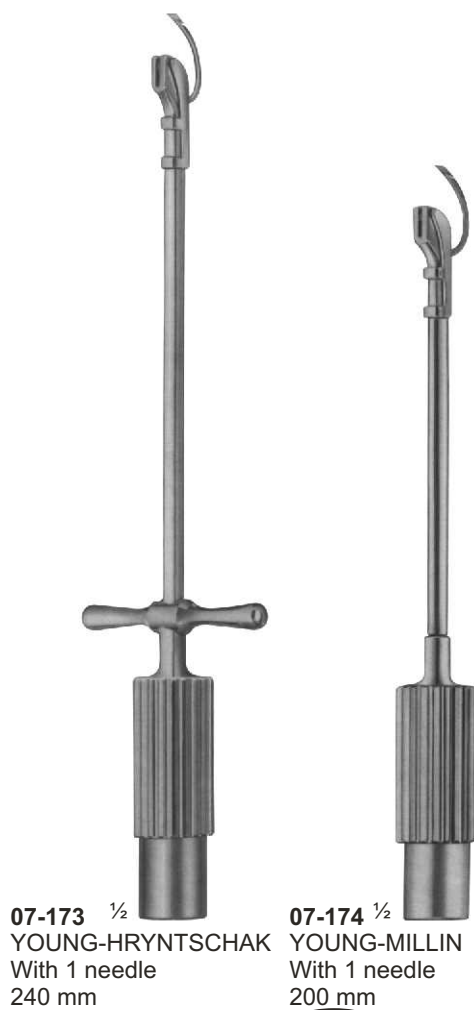
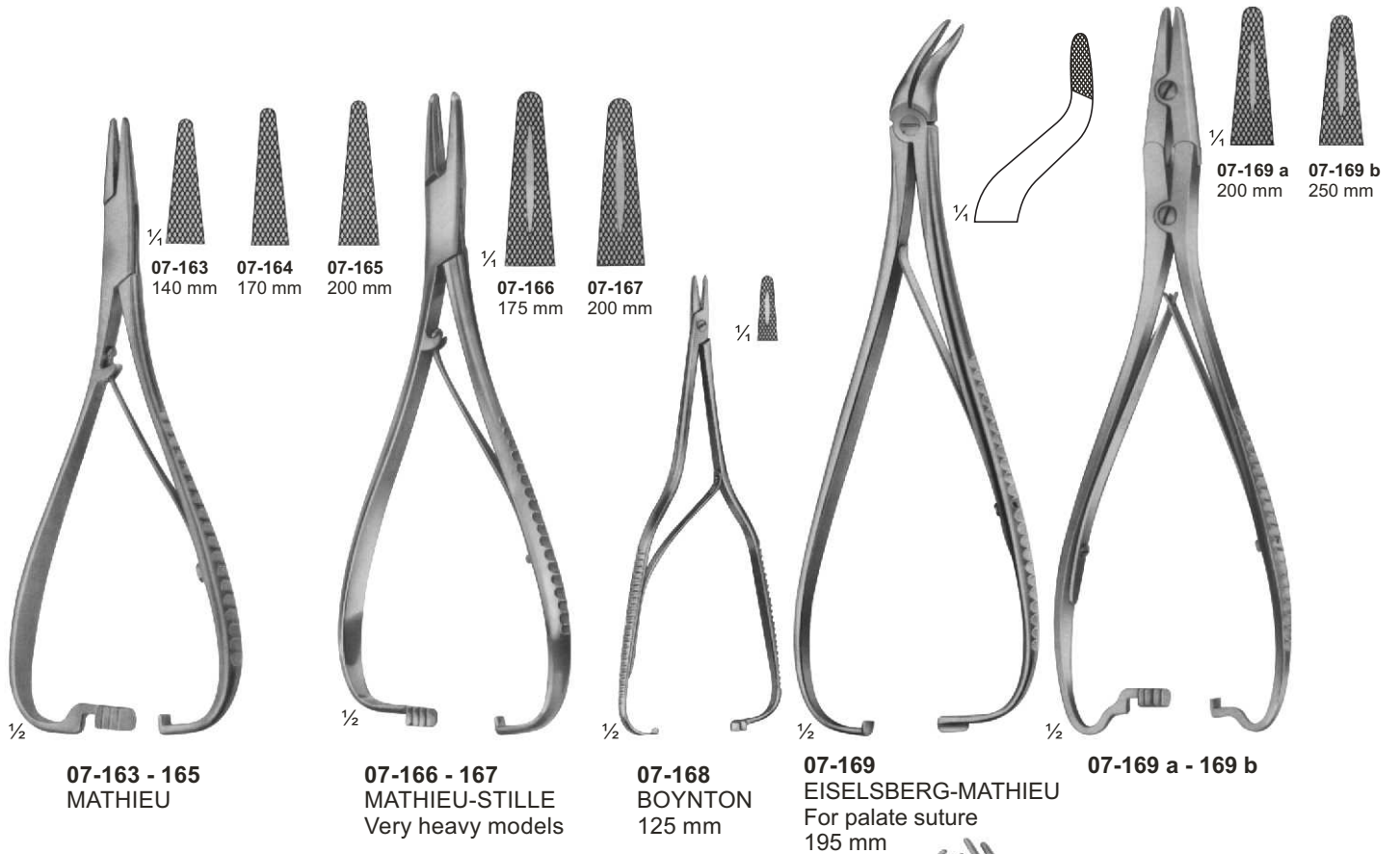

Suture Instruments - Reverdin Needles

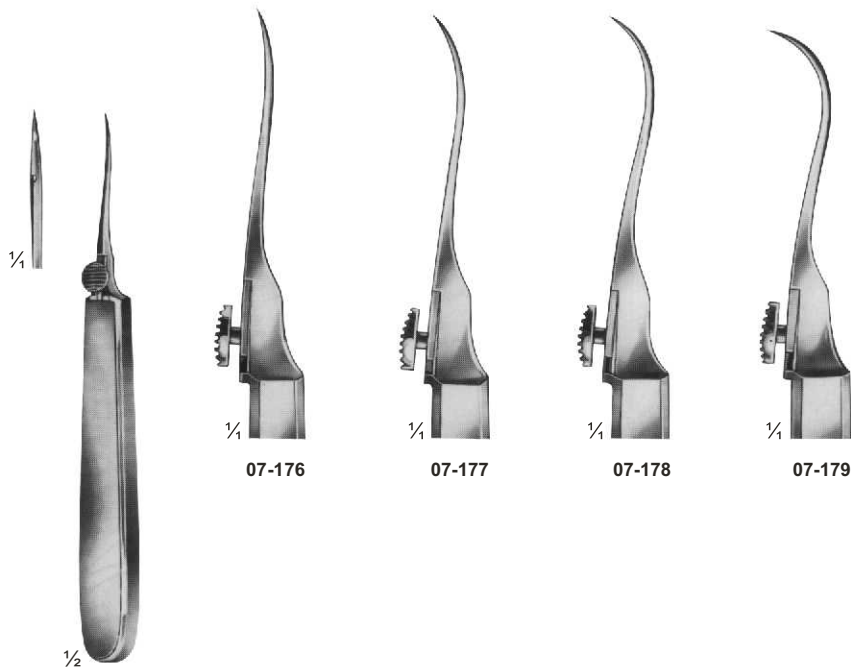

07-176 - 179
REVERDIN
140 mm



07-180 - 183
REVERDIN
195 mm

07-184 - 188
REVERDIN
220 mm

Suture Instruments - Ligature Needles

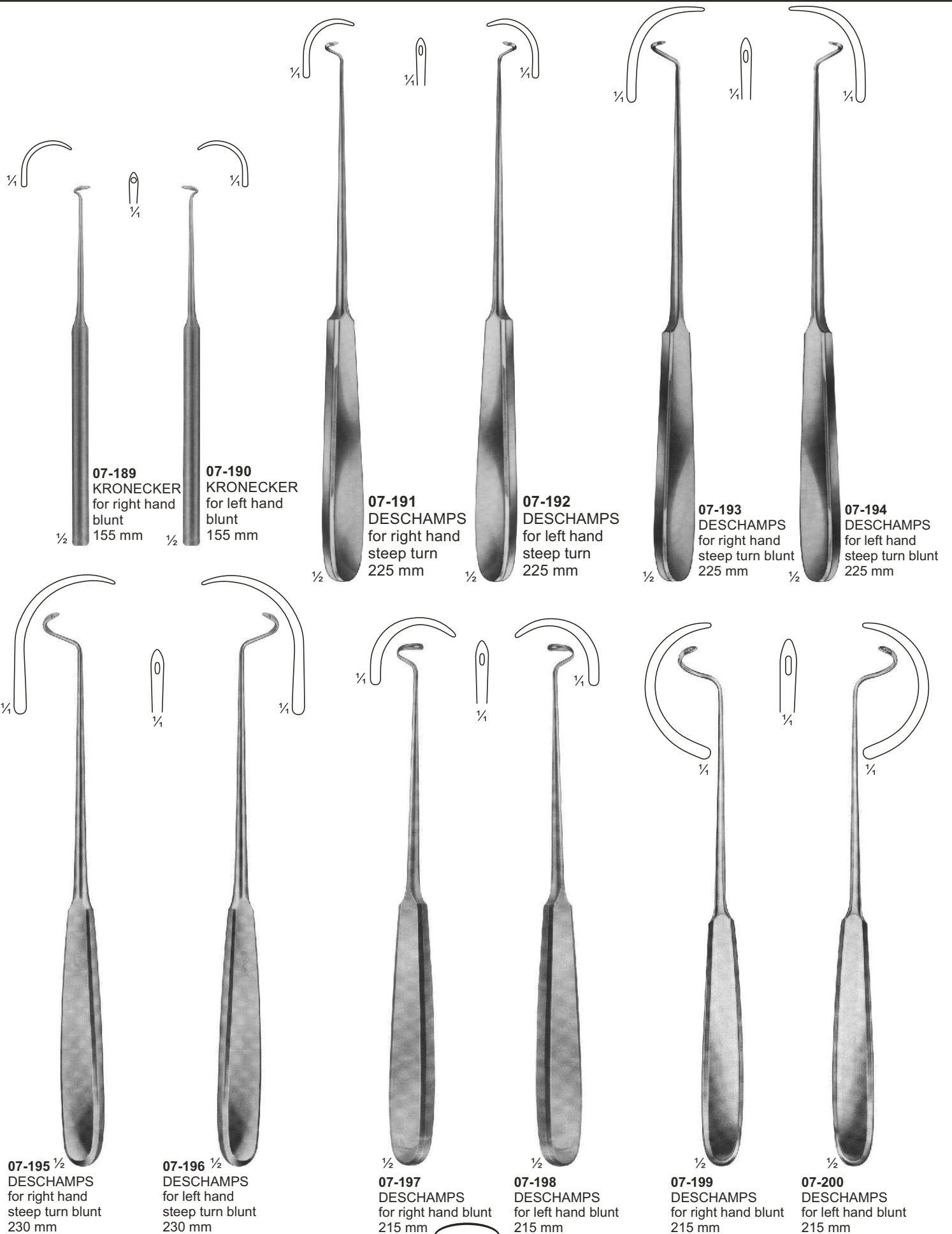

Suture Instruments - Ligature Needles



07-201
HURD
for right hand
sharp
210 mm



07-202
HURD
for left hand
sharp
210 mm



07-203
DESCHAMPS
for right hand
sharp
215 mm



07-204
DESCHAMPS
for left hand
sharp
215 mm



07-205
JONESCO
Needle for wire suture
185 mm



07-206
CLAUS VAN EICKEN
Needle for wire suture
250 mm

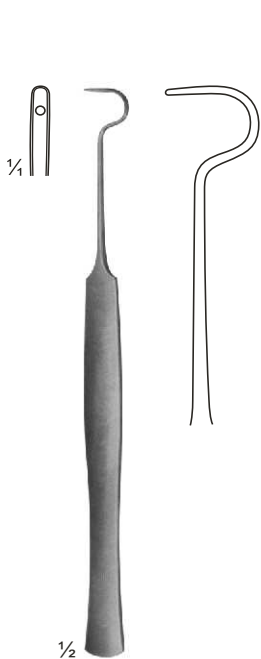

07-207
150 mm

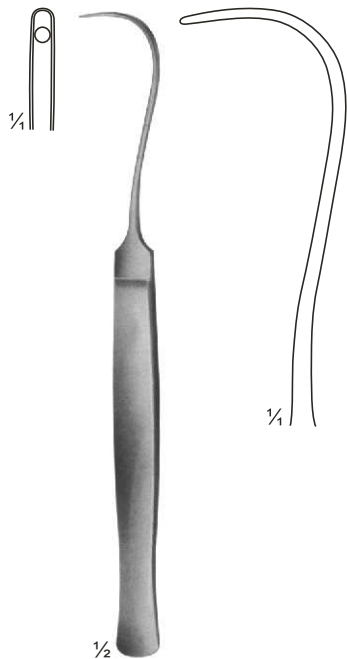

07-208
SYME
170 mm

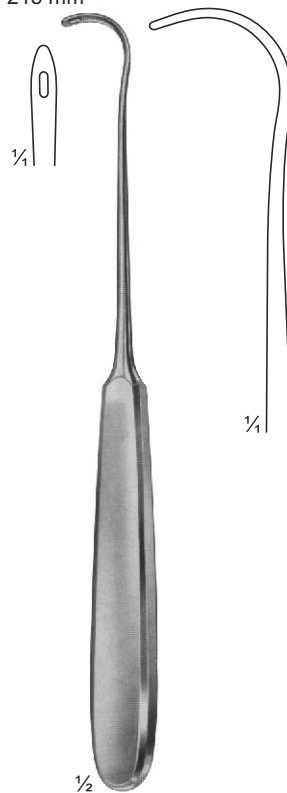

07-209
COOPER
205 mm

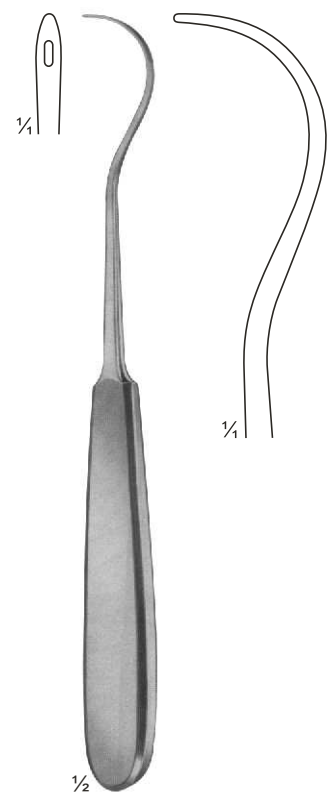

07-210
KOCHER
205 mm

Ligature Needles

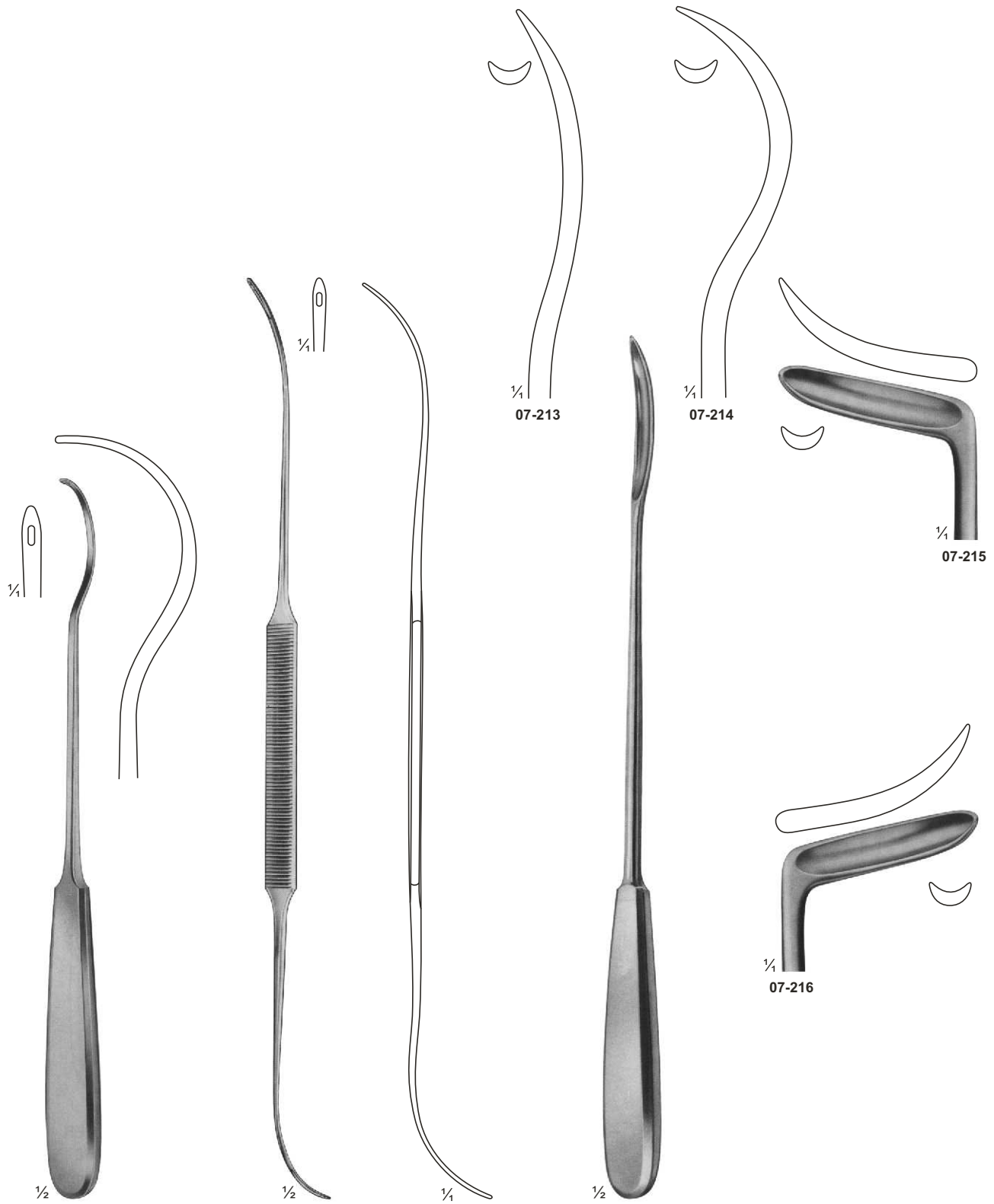

07-211
BRUNNER
240 mm

07-212
SCHMIEDEN-DICK
320 mm

07-213 - 216
BRUNNER
Guiding Probes
300 mm

Guiding Probes

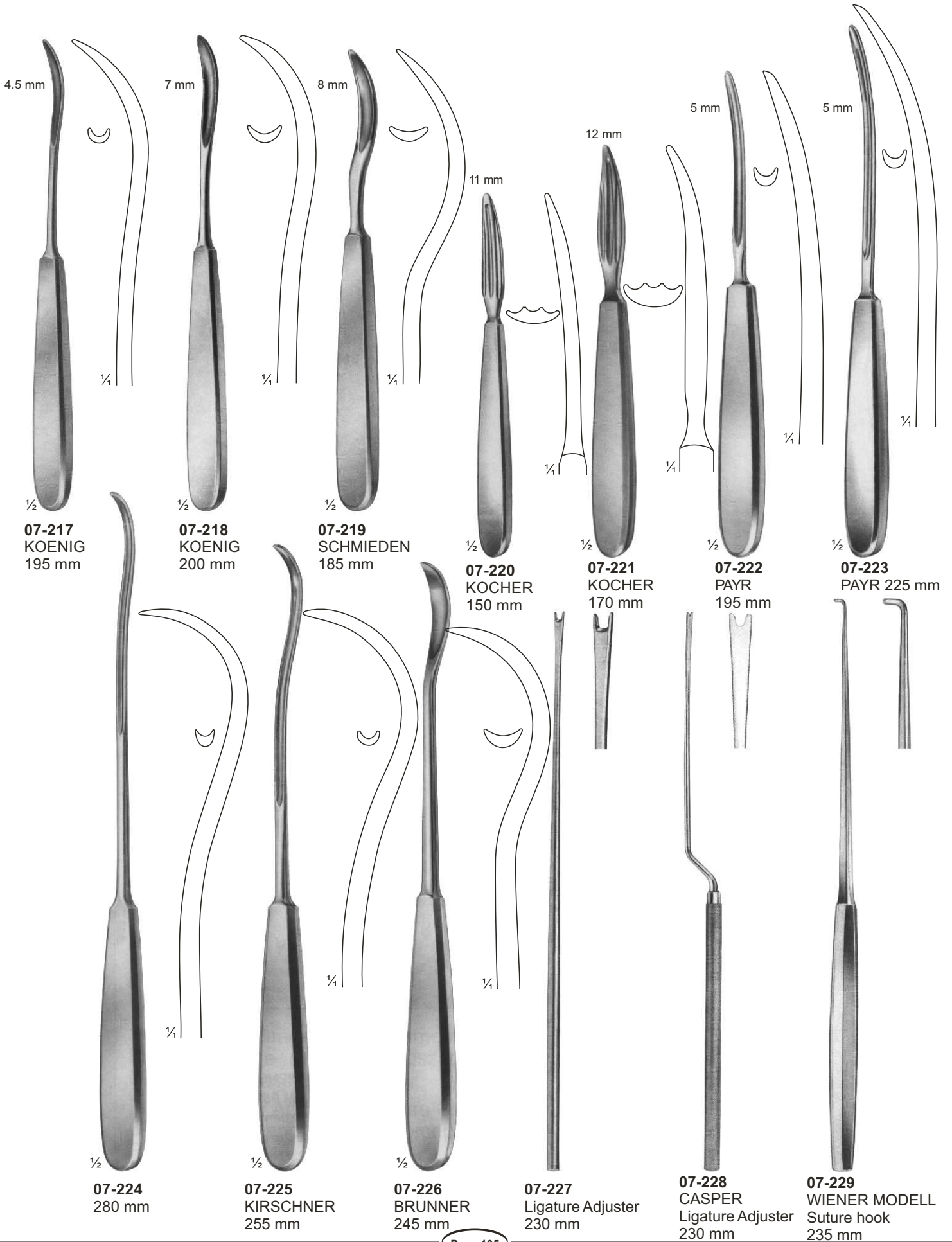

Probes



07-242 2,5 mm
07-243 2,5 mm
07-244 3,0 mm

1/2

07-242 145 mm
07-243 160 mm
07-244 200 mm
 Probes with eye



1,5 mm

1/2

07-245
 Myrtle leaf probe
 145 mm



2,0 mm

1/2

07-246 130 mm
07-247 145 mm
07-248 160 mm
07-249 180 mm
07-250 200 mm



1/2

07-251
 Probes



1/2

07-252
 Double ended probe,
 malleable, diam. of tips
 3 mm with hole
 190 mm



07-253
 Double ended probes,
 tin, malleable,
 diam. of tips
 3,5 mm with hole
 250 mm, 300 mm



1/4

07-254
 Double ended probes,
 tin, malleable,
 diam. of tips 4 mm
 400 mm



1/3

07-255 1,5 mm
07-256 2,0 mm
07-257 2,5 mm
 300 mm

Probes



07-242 2,5 mm
07-243 2,5 mm
07-244 3,0 mm

07-242 145 mm
07-243 160 mm
07-244 200 mm
 Probes with eye



07-245 145 mm
 Myrtle leaf probe



07-246 130 mm
07-247 145 mm
07-248 160 mm
07-249 180 mm
07-250 200 mm



07-251 Probes



07-252 190 mm
 Double ended probe,
 malleable, diam. of tips
 3 mm with hole



07-253 250 mm, 300 mm
 Double ended probes,
 tin, malleable,
 diam. of tips
 3,5 mm with hole



07-254 400 mm
 Double ended probes,
 tin, malleable,
 diam. of tips 4 mm



07-255 300 mm 1,5 mm
07-256 2,0 mm
07-257 2,5 mm

Probes - Spatulas - Cotton Applicators



07-258
STACKE
100 mm



07-259
KILLIAN
165 mm



07-260
160 mm



07-261
SEIFFERT
180 mm



German Silver

07-262
BOWMAN
130 mm



07-263
SPATULA
145 mm



07-264
SPATULA
145 mm



07-265
Modell PICCOLO
Round Serrated
110 mm



07-266
Modell PICCOLO
Triangular Serrated end
110 mm



07-267
FARRELL
Round Serrated end
110 mm



07-268
LATHBURY-FARREL
Triangular Serrated end
110 mm



Cotton Applicators



07-269
BUCK
Rough, spiral end
120 mm

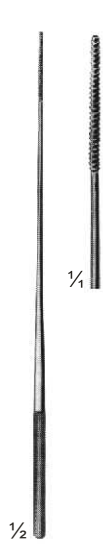

07-270
Triangular
serrated end
140 mm



07-271
Rough, spiral end
140 mm



07-272
Rough, spiral end
140 mm



07-273
Rough, spiral end
140 mm



07-274
FARRELL
Round,
serrated end
140 mm



07-275
LATHBURY-FARRELL
Triangular,
serrated end
140 mm

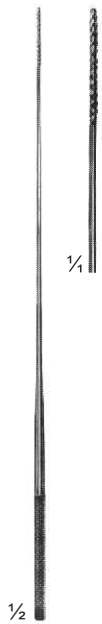

07-276
FARRELL
Rough,
spiral end
160 mm

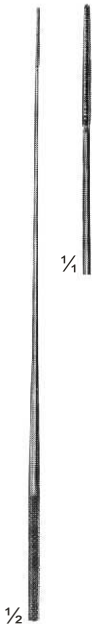

07-277
LATHBURY-FARRELL
Triangular,
serrated end
160 mm



07-278
Triangular,
serrated end
160 mm

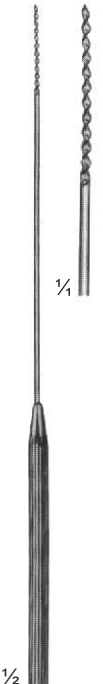

07-279
Rough,
spiral end
180 mm



07-280
Rough,
spiral end
180 mm

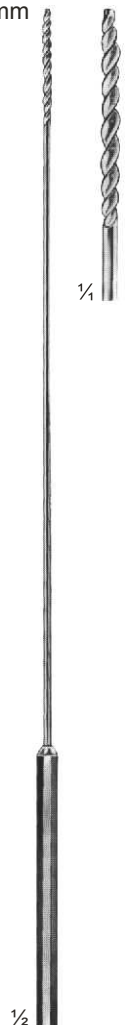

07-281
Rough,
spiral end
270 mm

Clip Applying Forceps - Suture Set



½
07-282
MICHEL
125 mm



½
07-283
HEGENBARTH
120 mm



½
07-284
WACHENFELDT
120 mm



½
07-285
WACHENFELDT
120 mm



½
07-286
MICHEL
125 mm



½
07-287
MICHEL modif.
130 mm



½
07-288
HEATH
135 mm

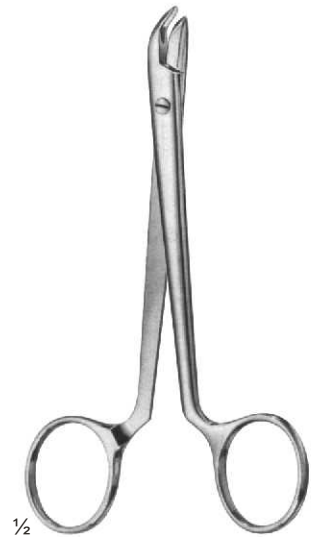

½
07-289
COLLIN
135 mm

Clip Applying Forceps - Suture Set



07-290

Suturing instruments set, in metal case consisting of: Scissors, curved, sharp/sharp, 115mm
25 MICHEL clip, 16 x 3mm
1 Delicate tissue forceps, 130mm
1 Scalpel, bellied
1 MATHIEU needle holder, 140mm
1 Perforated metal case, stainless containing:
1 Suture needle
1 item 1 item



07-291

Pocket instrument set, in metal case consisting of:

Bottom tray

1 MATHIEU needle holder, 140mm
1 MICHEL clip forceps, combined
1 Myrtle leaf probe, 130mm
1 Sharp double curette
1 Skin hook
1 Detachable scalpel handle, no.4
1 Perforated metal case, containing
6 Scalpel blades BB 520
1 Perforated metal case, stainless, containing
1 Suture needle
1 item
1 item

Top tray

1 Tissue forceps, 130mm
1 KOCHER haemostatic forceps, 130mm
1 Straight surgical scissors, 130mm
1 Dissecting forceps, 130mm
1 FEILCHENFELD splinter forceps, 115mm
25 MICHEL clip, 16 x 3mm
1 Flacon of suture skin, sterile in alcohol

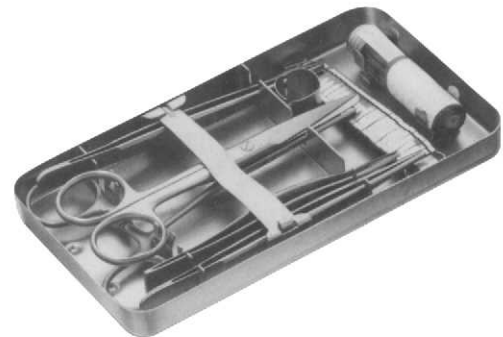

07-292

Pocket instrument set, in metal case consisting of:

Bottom tray

1 MAYO-HEGER needle holder, 150mm
1 MICHEL clip forceps, combined
1 Myrtle leaf probe, 130mm
1 Sharp double curette
1 Skin hook
1 Detachable scalpel handle, no. 4
1 Perforated metal case, consisting
6 Scalpel blades BB 520
1 Perforated metal case, stainless, consisting:
1 Suture needle
1 item, & 1 item

Bottom tray

1 Tissue forceps, 130mm
1 CRILE haemostatic forceps, 140mm
1 Straight surgical scissors, 130mm
1 Dissecting forceps, 130mm
1 FEILCHENFELD splinter forceps, 115mm
25 MICHEL clip, 16 x 3mm
1 Flacon of suture silk, sterile in alcohol

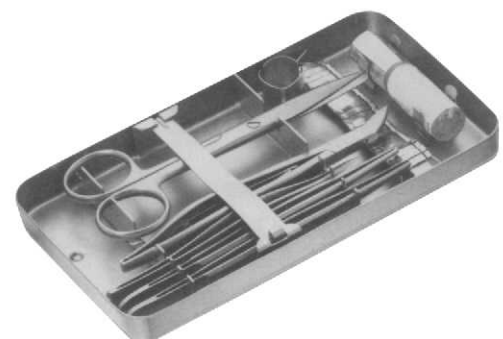

Clip Applying Forceps - Suture Set

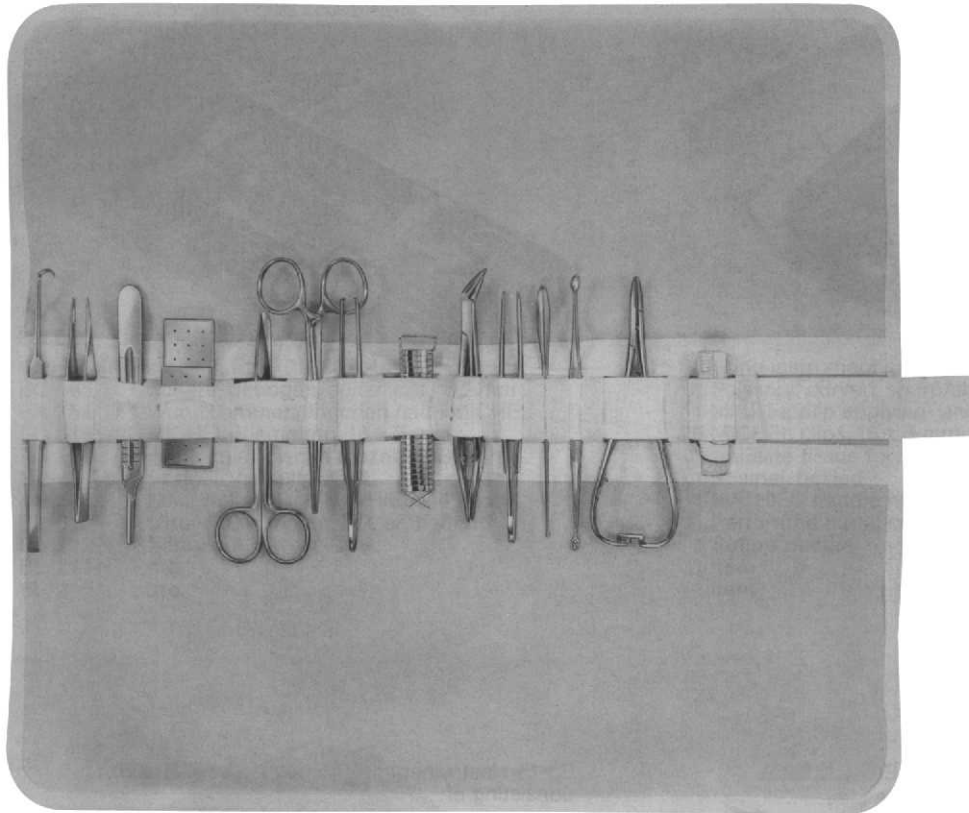

07-293

Pocket instrument set in metal case 170 x 90mm with sterilizable canvas roll consisting of:

- 1 Myrtle leaf probe, 130mm
- 1 Sharp double curette
- 1 FEILCHENFELD splinter forceps, 115mm
- 1 Dissecting forceps, 130mm
- 1 Tissue forceps, 130mm

- 1 Straight surgical scissors, 130mm
- 1 Scalpel handle no. 4
- 1 Perforated metal case, consisting of 6 scalpel blades BB 520
- 1 KOCHER haemostatic forceps, 130mm
- 1 Skin hook
- 1 MATHIEU needle holder, 140mm
- 1 Tube of suture skin, sterile in alcohol
- 1 MICHEL clip forceps, 120mm

- 25 MICHEL clip, 16 x 3mm**
- 1 Perforated metal case, stainless, consisting:**
- 1 Suture needle**
- 1 item**
- 1 item**

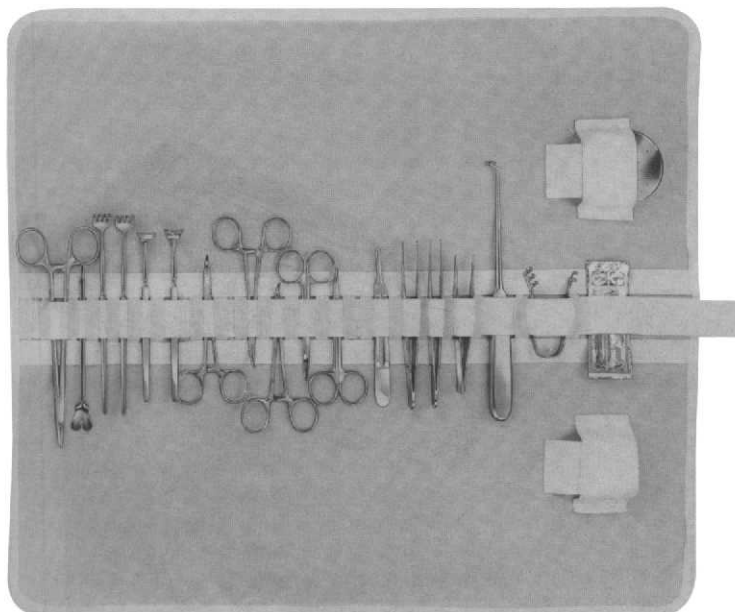

07-294

Venae sectio set, in sterilizable canvas roll consisting of:

- 1 Tissue forceps, 1 x 2 teeth, 140mm
- 1 Dissecting forceps, 145mm
- 1 FEILCHENFELD straight scissors, sharp, 110mm
- 1 curved scissors, blunt, 115mm
- 1 HALSTED mosquito forceps, curved on flat, 125mm

- 1 DESCHAMPS needle, blunt, 210mm
- 1 DOYEN Director, curved, 140mm
- 2 Wound retractors, 4 blunt prongs, 160mm
- 2 DESMARRES wound retractors, 135mm
- 1 FINSEN retractors, 2 x3 blunt prongs, 80mm

- 1 Scalpel handle no. 4
- 4 Sterile scalpel blades, no 18, single peel pack
- 1 Needle box, perforated, round, diam. 65mm
- 1 HEGAR-MAYO DUROGRIP needle holder, 180mm

Clip Applying Forceps - Suture Set

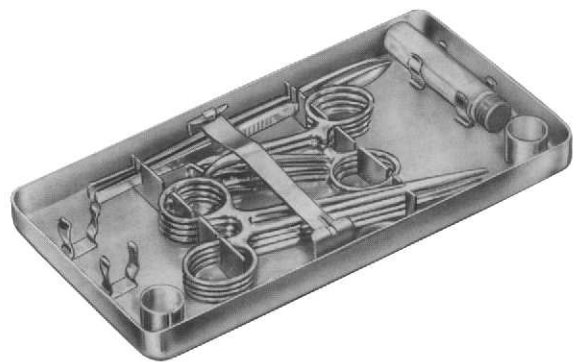
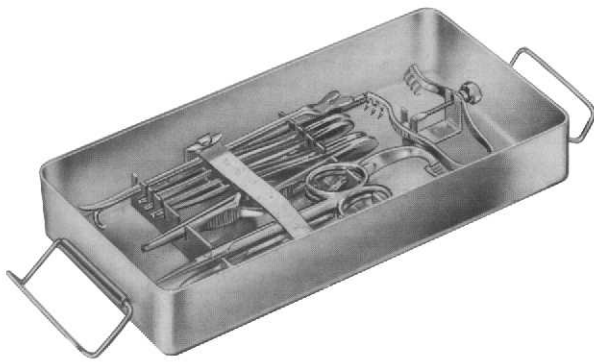

07-295

Venae sectio set, in metal case
consisting of:

Bottom tray

- 1 MATHIEU needle holder, fine pattern 140mm
- 1 Ligature needle, fine short pattern
- 1 DOYEN director, curved
- 1 HEGENBARTH clip forceps,
- 1 ELSCHNIG tissue forceps, 1 x 2 teeth fine, 150mm
- 1 Dressing forceps, fine 105mm
- 1 Tissue forceps, 1 x 2 teeth, 110mm
- 1 Vessel scissors, straight, with 1 ball point, 110mm
- 1 Vessel scissors, curved, pointed 105mm
- 1 FINSEN retractor
- 1 Perforated needle case

Top tray

- 1 Scalpel, pointed
- 1 Scalpel, bellied
- 2 HALSTED mosquito forceps, curved, 125mm
- 2 HALSTED mosquito forceps, straight, 1x 2 teeth, 125mm
- 3 BACKHAUS towel forceps, 90mm
- 2 Flacon holder

Nerve - and Vessel Hooks

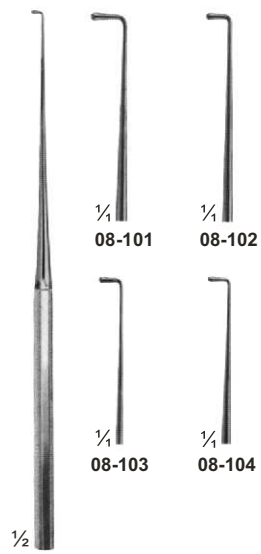

08-101 - 104
WAGENER
150 mm

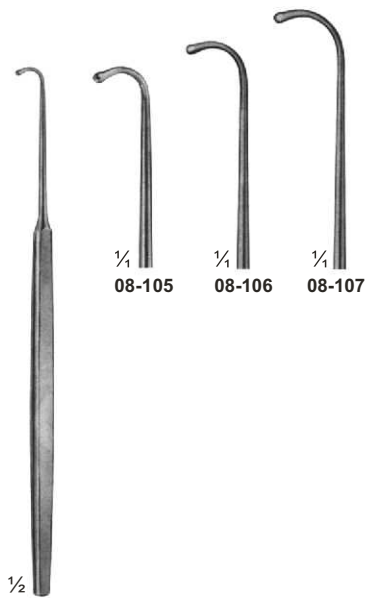

08-105 - 107
GRAEFE
140 mm



08-108
BROM
Vein hook
170 mm

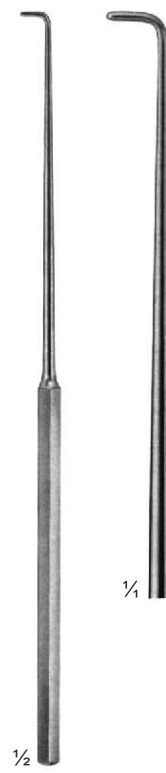

08-109
CRILE
200 mm



08-110 - 111
CUSHING
190 mm

Nerve - and Vessel Hooks

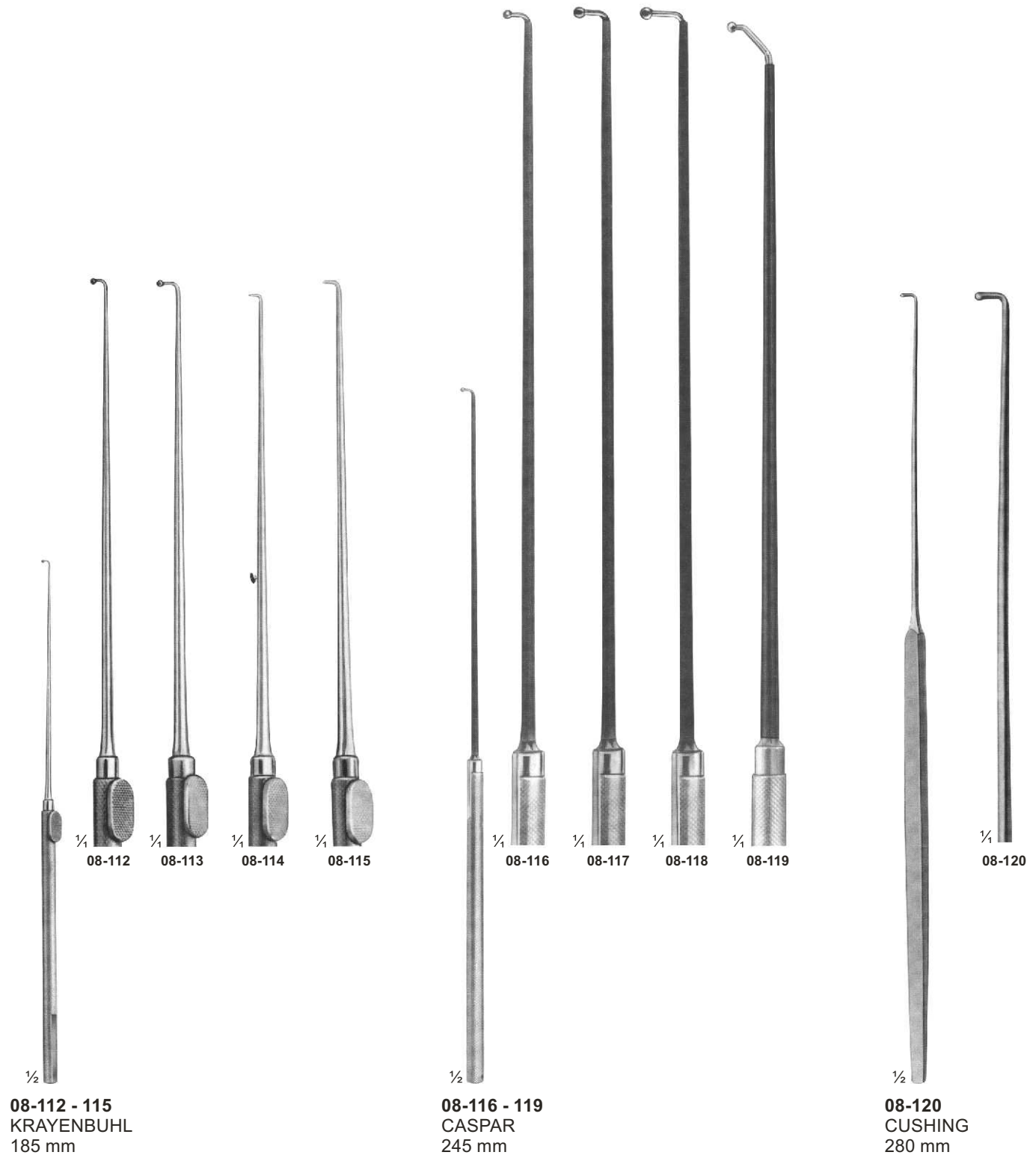

Fine Wound Retractors (Dura- and Skin Retractors)

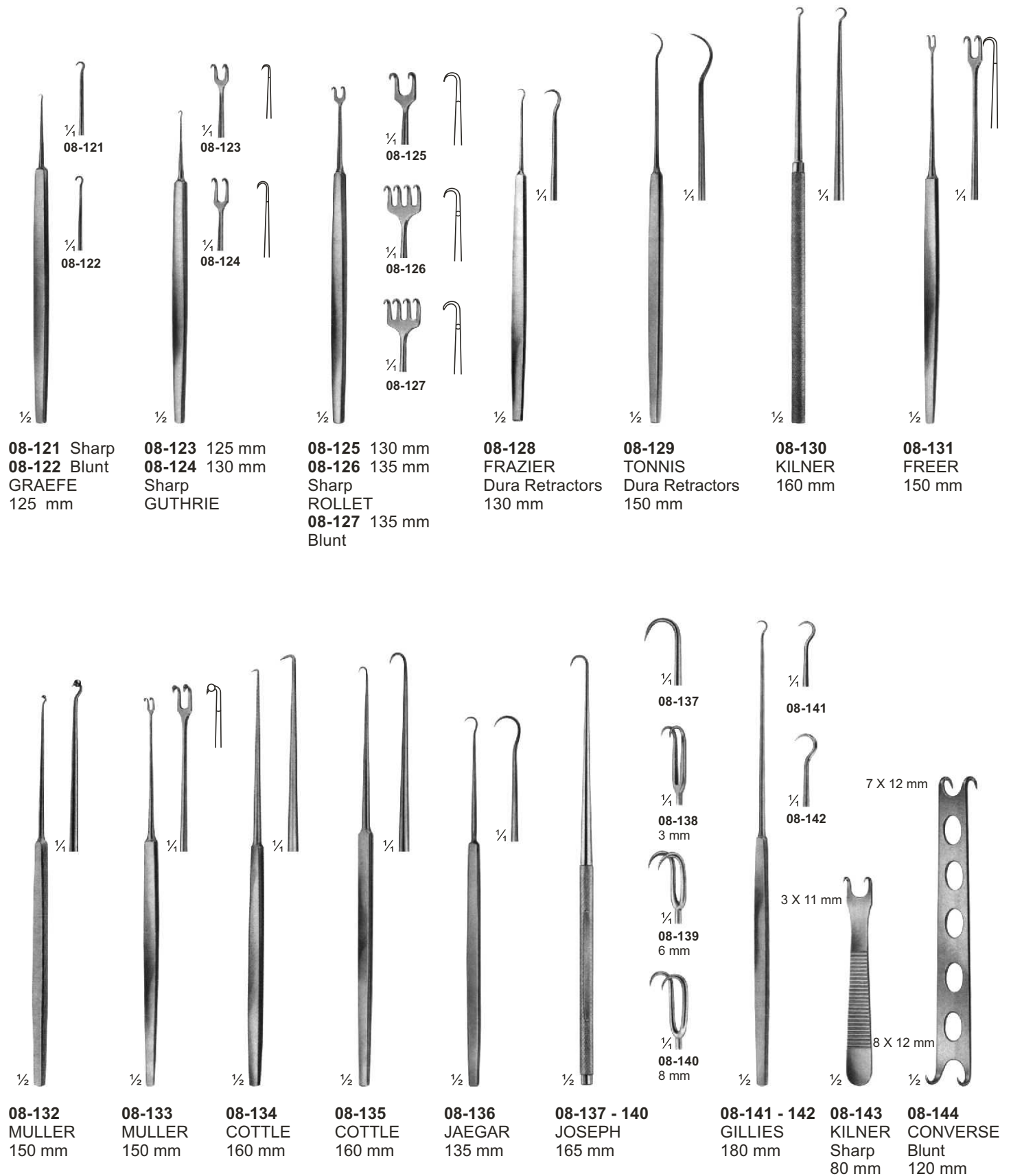

Wound - Trachea Retractors

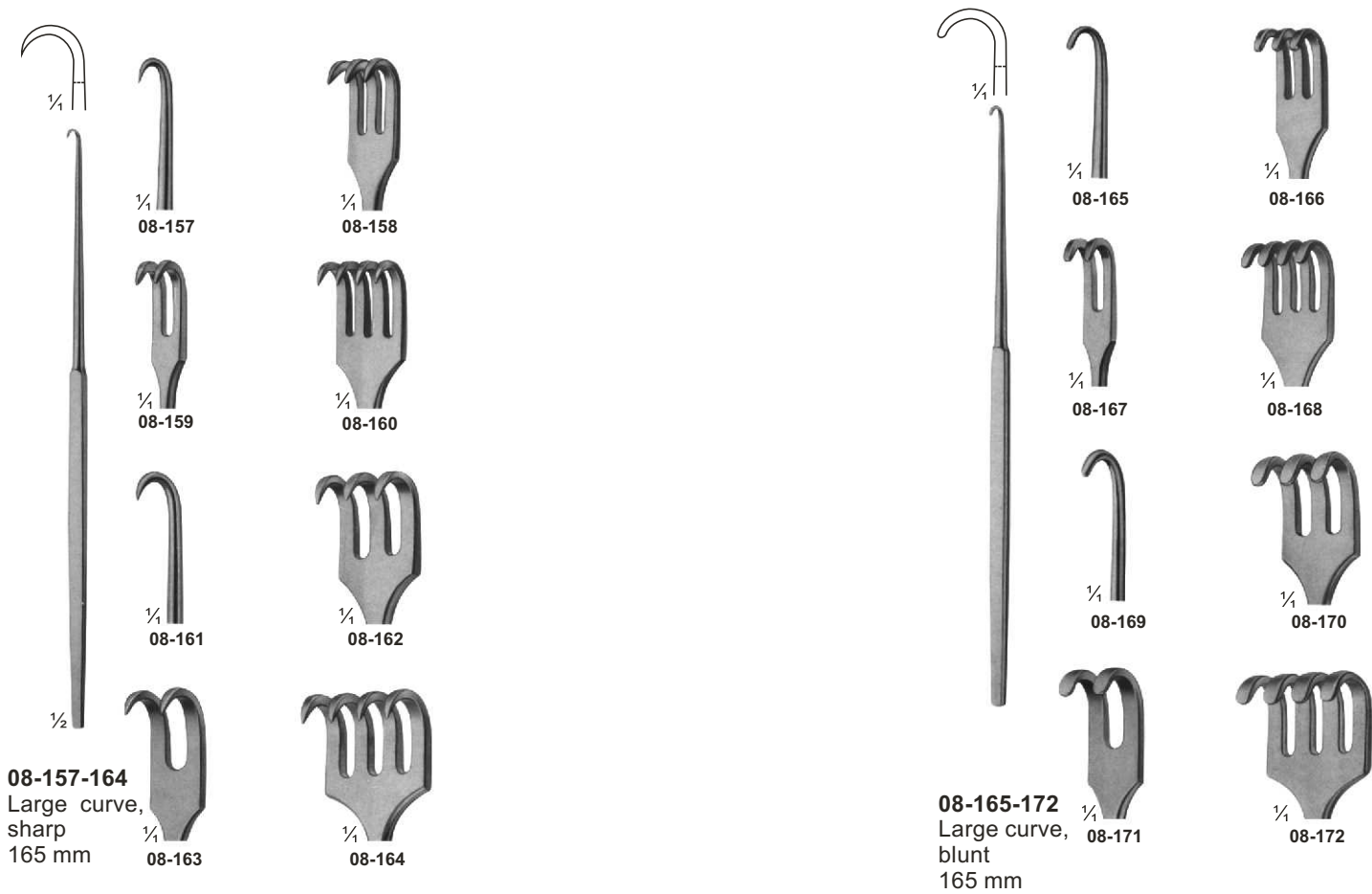
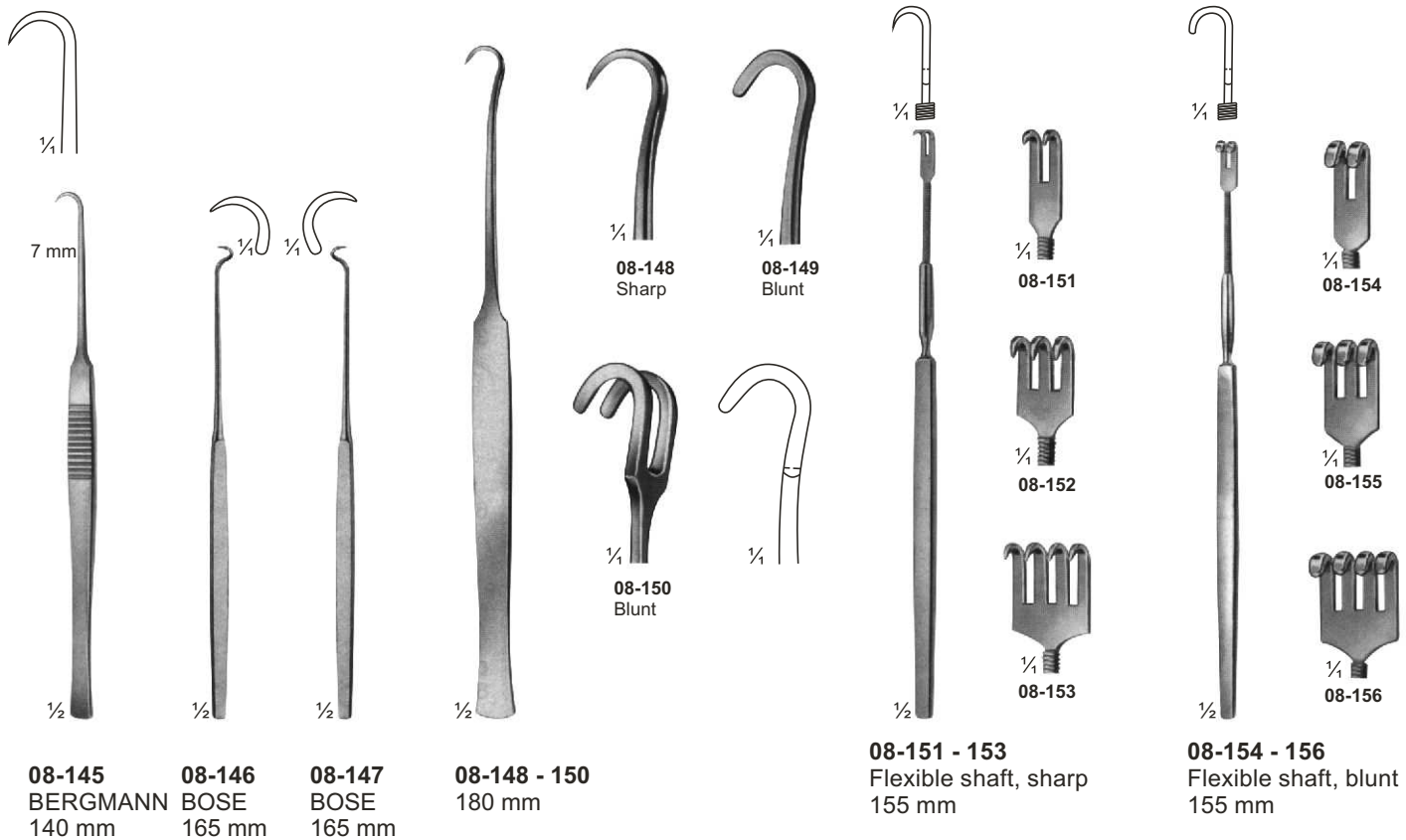

Retractors With Treangle Handle

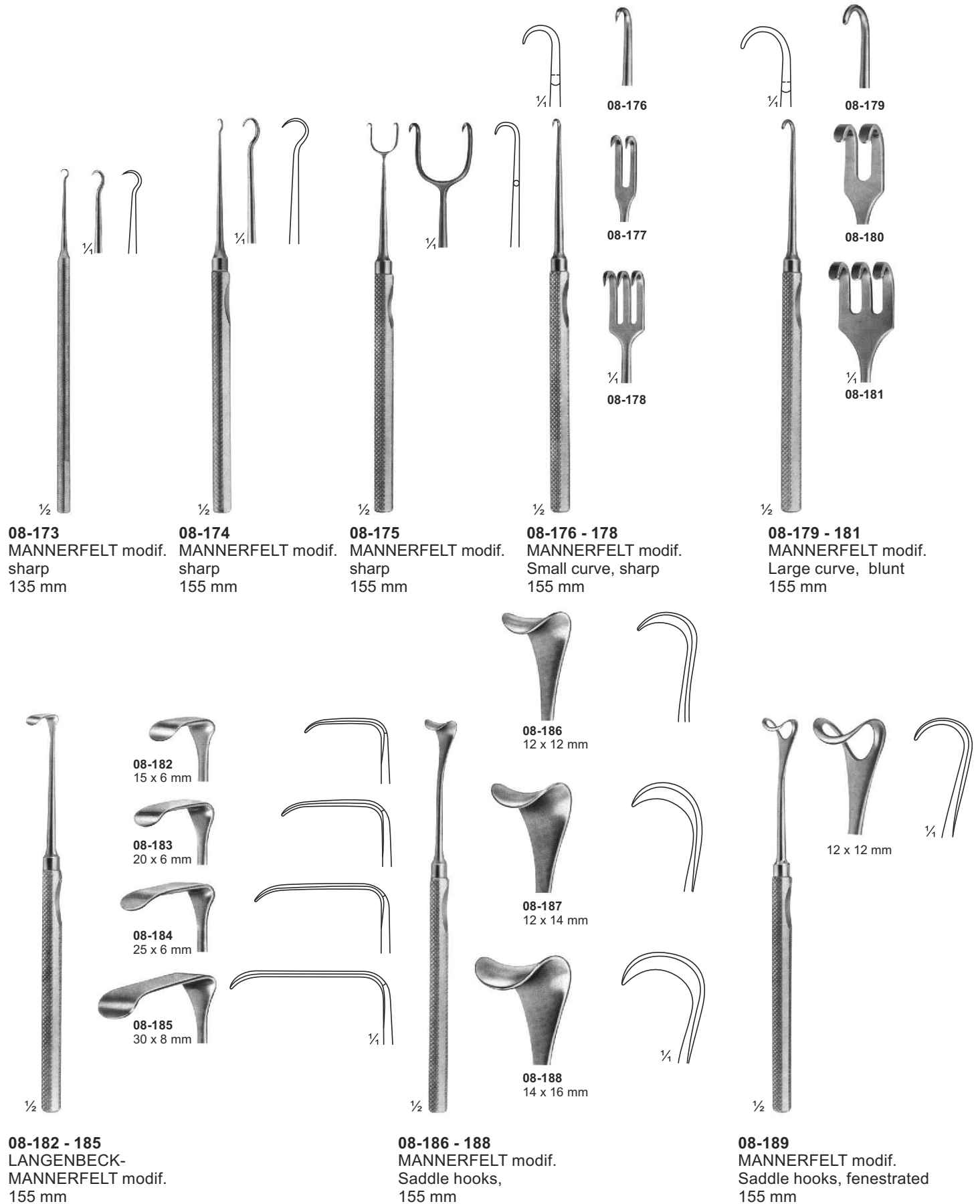

Retractors

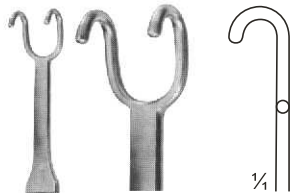

08-190
FOMON
145 mm

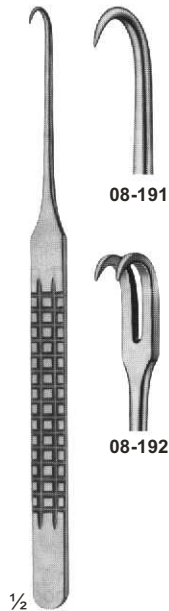

08-191 - 192
160 mm



08-193 - 194
LANGENBECK-GREEN
160 mm

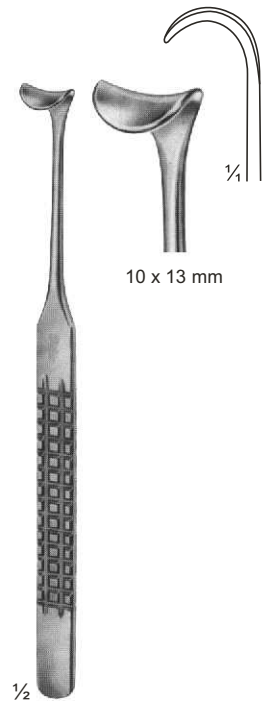

08-195
160 mm



08-196 - 201
MEYERDING
Fig. A - Fig. F
180 mm

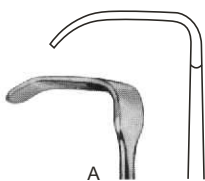

A
08-196
18 x 7 mm

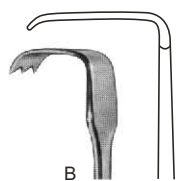

B
08-197
16 x 5 mm

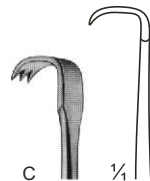

C
08-198
7 x 4 mm



D
08-199
5 x 10 mm

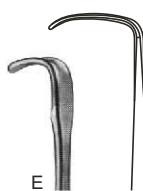

E
08-200
11 x 4 mm



F
08-201
6 x 4 mm

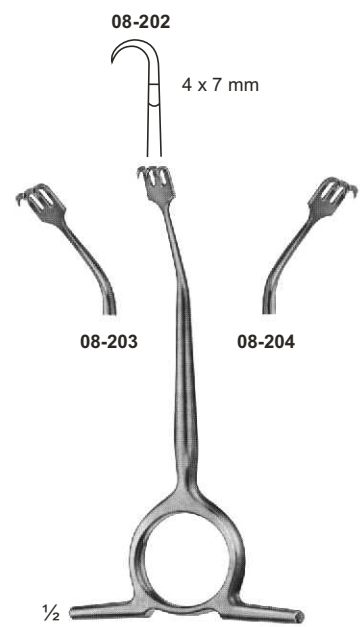

08-202 - 204
WILLIGER
120 mm

Retractors



08-205
EMMET
Fistula hook
220 mm



08-206
SIMON
Fistula hook
220 mm

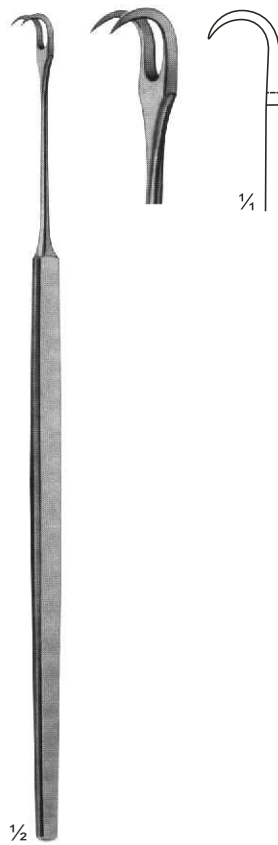

08-207
SIMON
Fistula hook
220 mm



08-208
LANGE
Fistula hook
230 mm

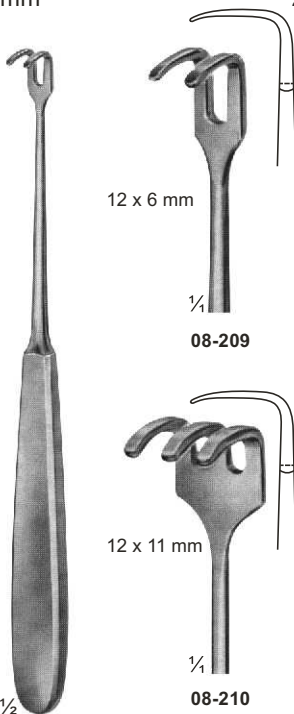

08-209 - 210
Tendon hooks
175 mm

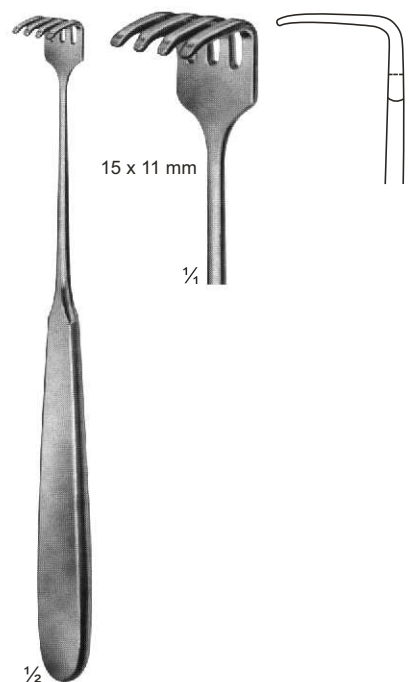

08-211
KLAPP
Tendon hooks
175 mm

Retractors

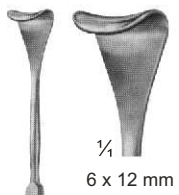

1/4
6 x 12 mm

1/2
08-212
MASING
140 mm

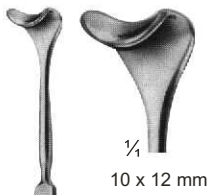

1/4
10 x 12 mm

1/2
08-213
COTTLE
140 mm



08-214
9 x 9 mm



08-215
9 x 12 mm

1/2
08-214 - 218
DESMARRES
140 mm



1/4
08-216
11 x 14 mm



1/4
08-217
12 x 16 mm



1/4
08-218
13 x 18 mm

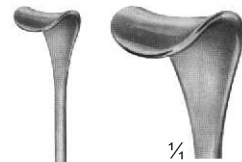

1/4
08-219
13 x 13 mm



1/4
10 x 10 mm

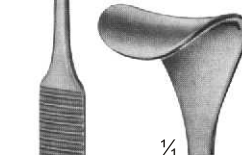

1/4
08-220
12 x 16 mm

1/2
08-219 - 220
KONIG
180 mm

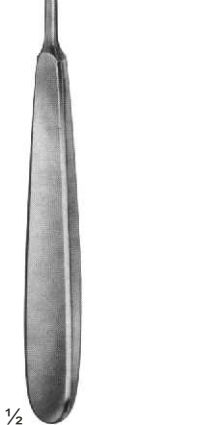

1/2
08-221
CUSHING-KOCHER
175 mm



1/4
08-222
20 x 12 mm

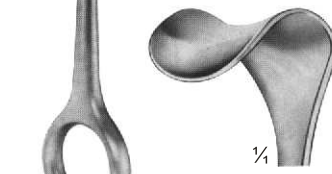

1/4
08-223
20 x 15 mm

1/2
08-222 - 223
KOCHER
205 mm



1/4
13 x 6 mm

1/2
08-224
SCHOENBORN
200 mm

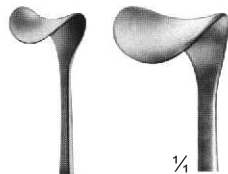

1/4
08-225
10 x 13 mm



1/4
08-226
14 x 18 mm

1/2
08-225 - 226
CUSHING
205 mm



20 x 15 mm

1/2
08-227
205 mm

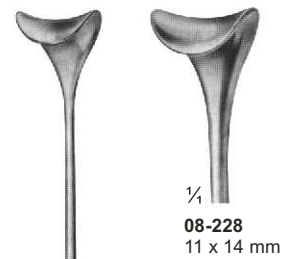

1/4
08-228
11 x 14 mm



1/4
08-229
13 x 18 mm

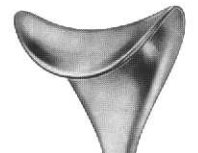

1/4
08-230
15 x 22 mm

1/2
08-228 - 230
CUSHING
250 mm

Retractors

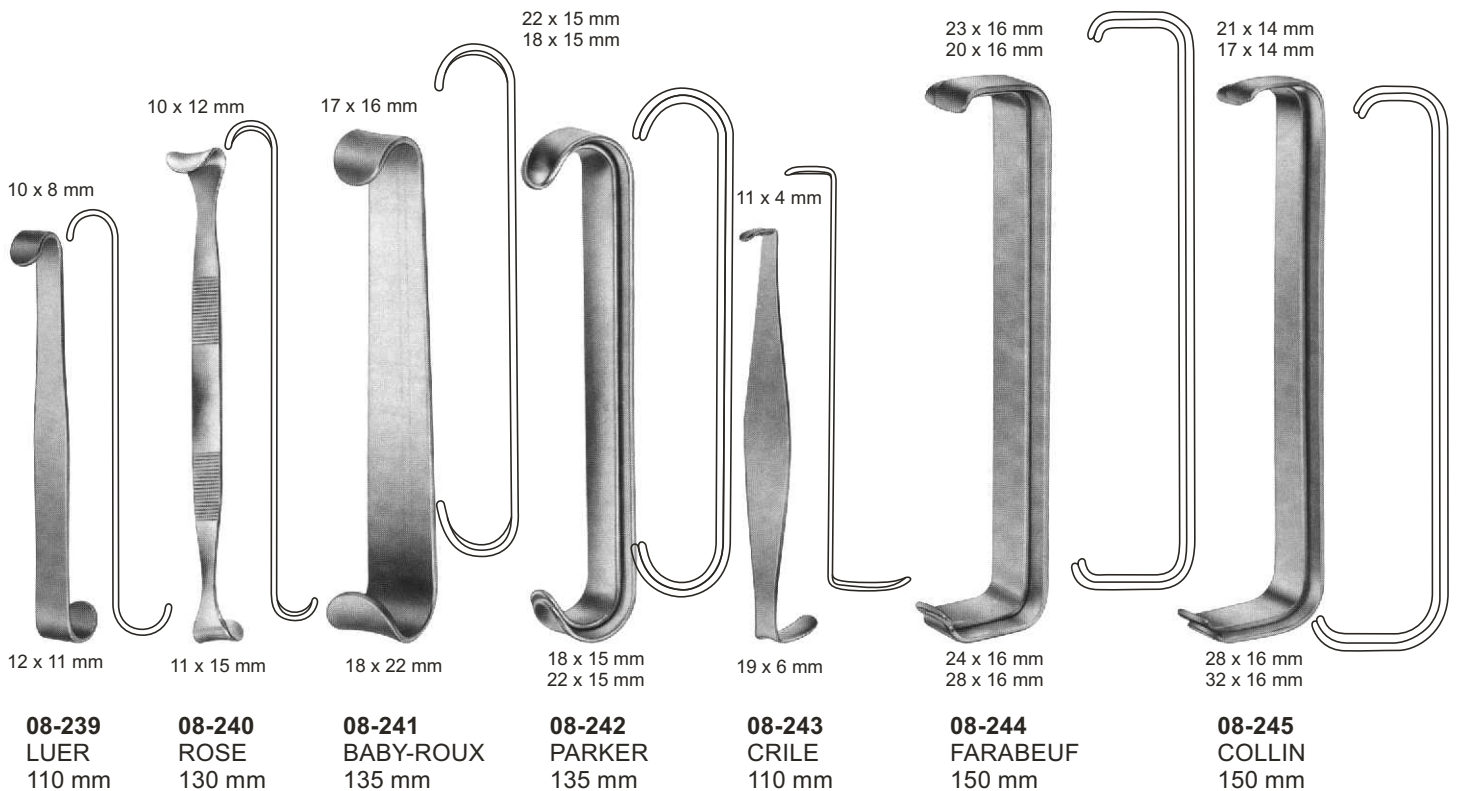

Retractors

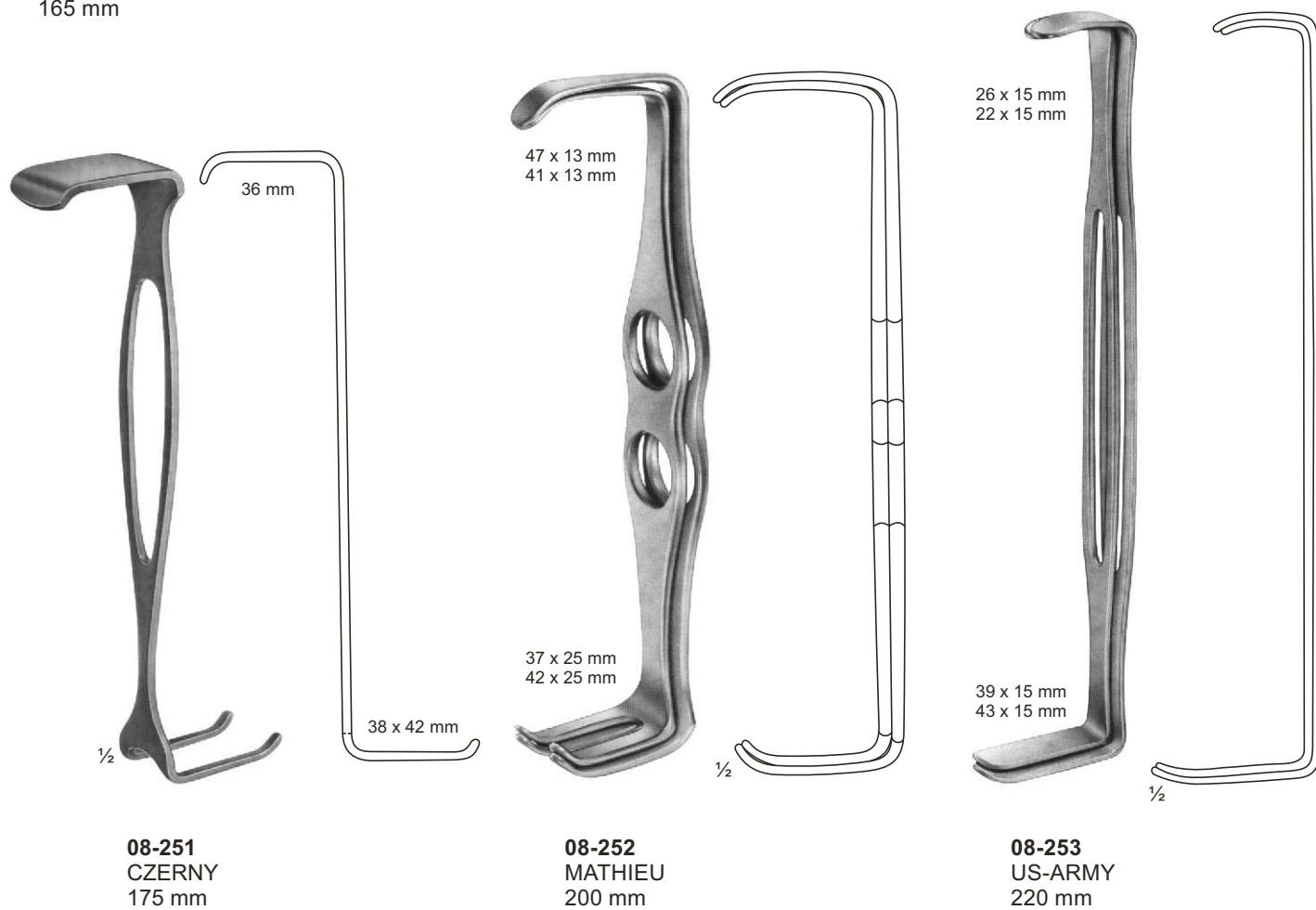
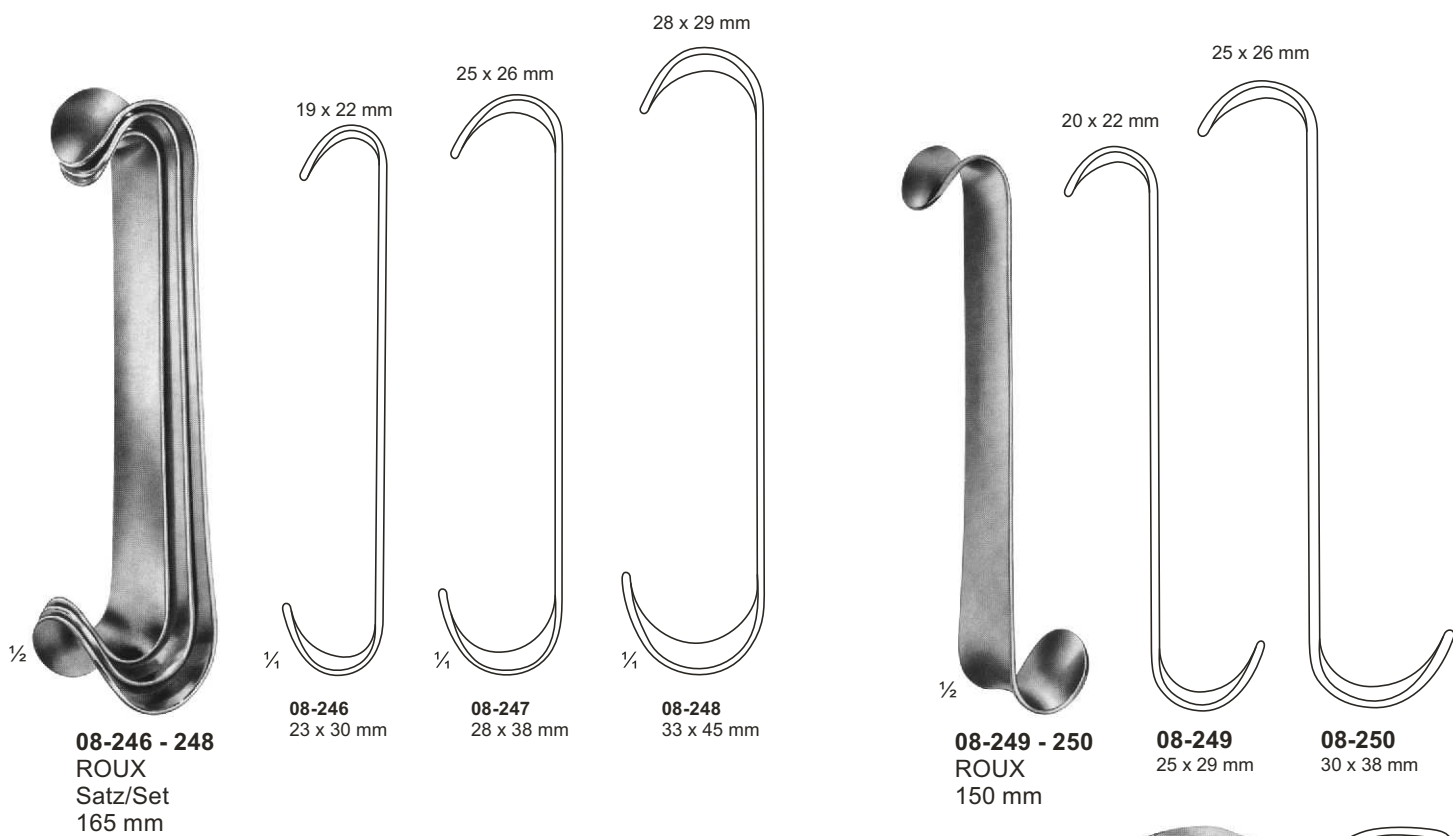

Bone Retractors and Retractors



08-254
KOCHER
Sharp
205 mm



08-255
KOCHER
Sharp
220 mm



08-256
KOCHER
Blunt
220 mm



08-257
VOLKMANN
Sharp
220 mm

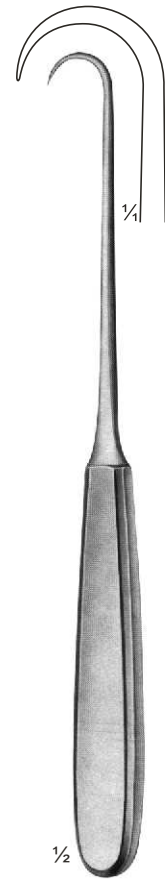

08-258
VOLKMANN
Sharp
220 mm



08-259 - 266
VOLKMANN
225 mm

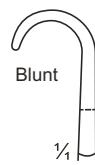
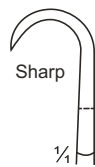

08-259
9 x 8 mm



08-260
9 x 13 mm



08-261
9 x 19 mm



08-262
9 x 29 mm



08-263
8,5 x 8 mm



08-264
8,5 x 13 mm



08-265
8,5 x 19 mm

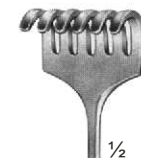

08-266
8,5 x 29 mm

Retractors

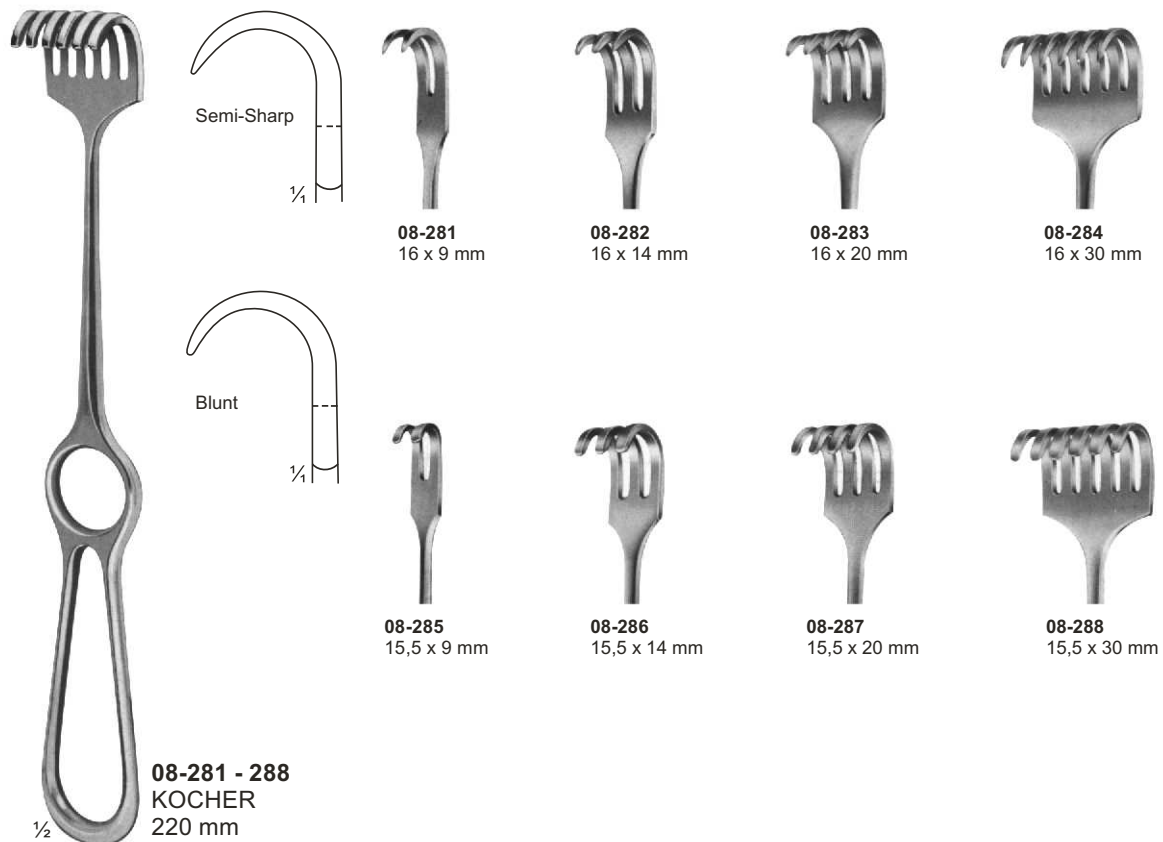
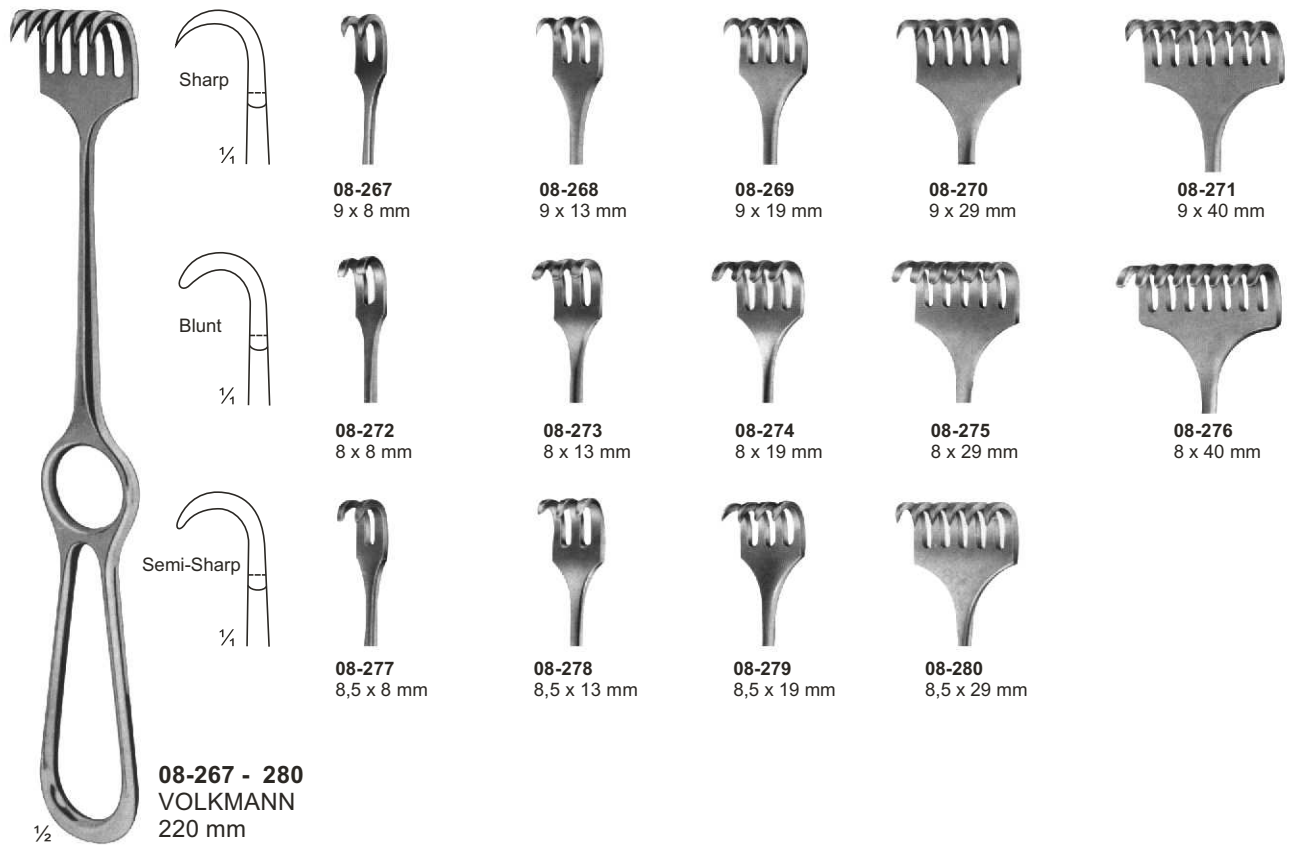

Retractors, Deep form

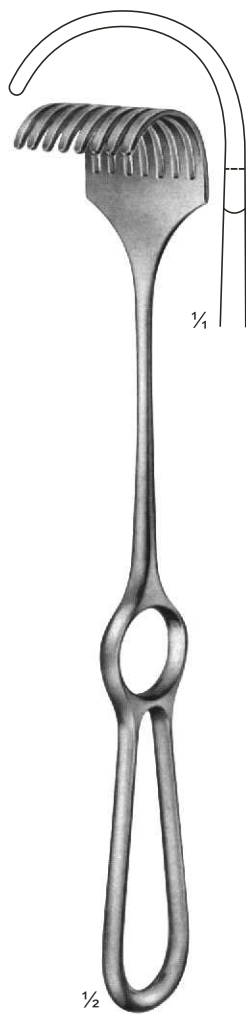

08-289 - 290
KORTE
240 mm



08-289
8 Prongs, blunt



08-290
8 Prongs, sharp

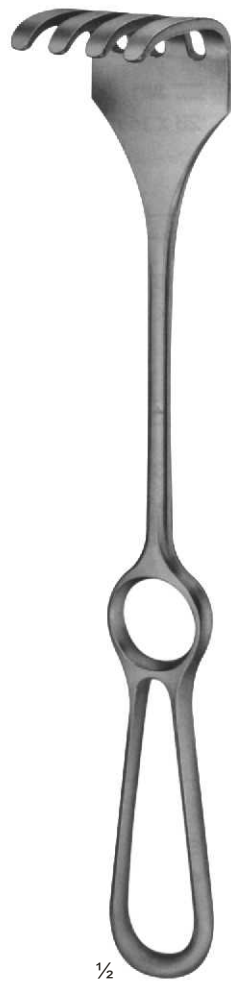

08-291 - 294
ISRAEL
255 mm

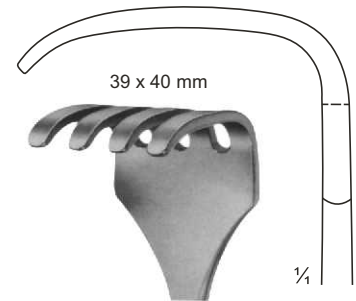

08-291
4 Prongs, blunt

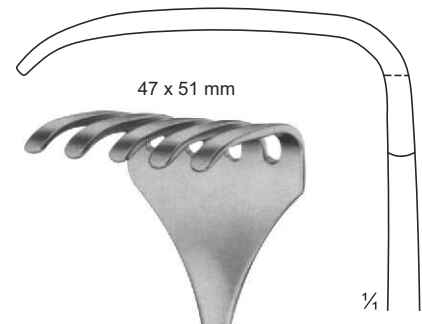

08-292
5 Prongs, blunt

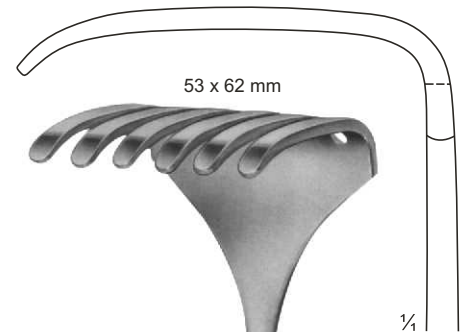

08-293
6 Prongs, blunt



08-294
6 Prongs, blunt

Retractors



08-294

1/2

08-295 - 300
LANGENBECK
210 mm

08-295 28 x 10 mm
08-296 28 x 14 mm
08-297 33 x 14 mm
08-298 28 x 16 mm
08-299 40 x 10 mm
08-300 40 x 13 mm



08-300

1/2

08-301 - 307
KOCHER-LANGENBECK
215 mm

08-301 25 x 6 mm
08-302 35 x 8 mm
08-303 35 x 11 mm
08-304 35 x 15 mm
08-305 41 x 11 mm
08-306 55 x 11 mm
08-307 70 x 14 mm



83 x 15 mm

1/4

Handle vertical to the Blade

1/2

08-308
LANGENBECK
215 mm

Retractors



08-309 - 313
KOCHER
230 mm

1/2

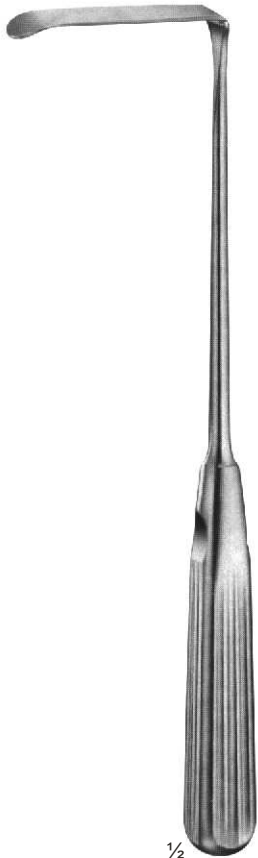

08-314 - 316
SAUERBRUCH
225 mm

1/2

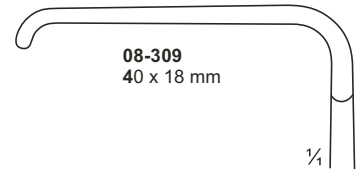

08-309
40 x 18 mm

1/4

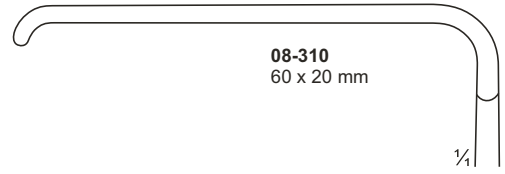

08-310
60 x 20 mm

1/4

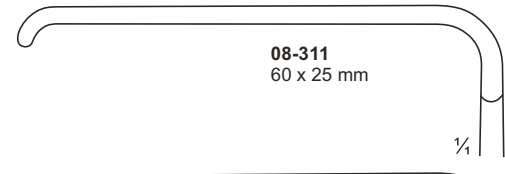

08-311
60 x 25 mm

1/4

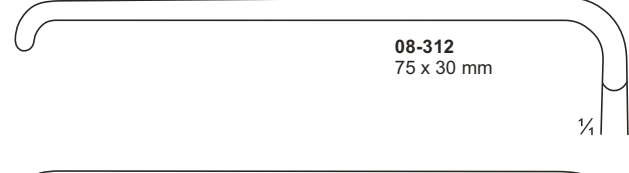

08-312
75 x 30 mm

1/4

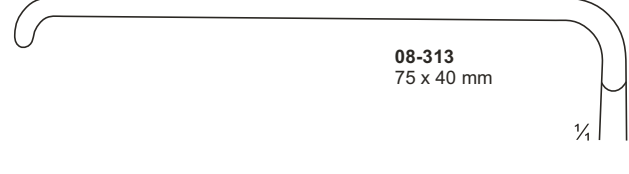

08-313
75 x 40 mm

1/4

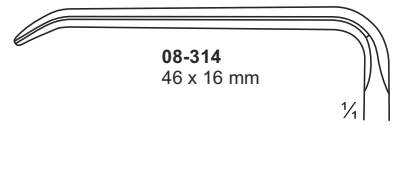

08-314
46 x 16 mm

1/4

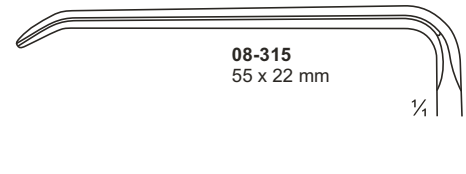

08-315
55 x 22 mm

1/4

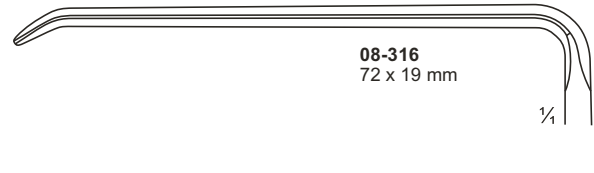

08-316
72 x 19 mm

1/4

Retractors



1/2
08-317
15 x 15 mm
220 mm

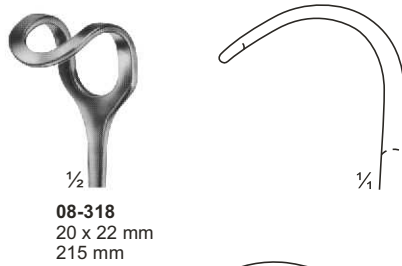

1/2
08-318
20 x 22 mm
215 mm

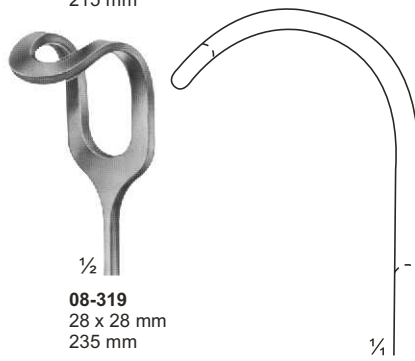

1/2
08-319
28 x 28 mm
235 mm

1/2
08-317 - 319
MIDDELDORPF



38 x 18 mm

1/2
08-320
BUCHS
205 mm

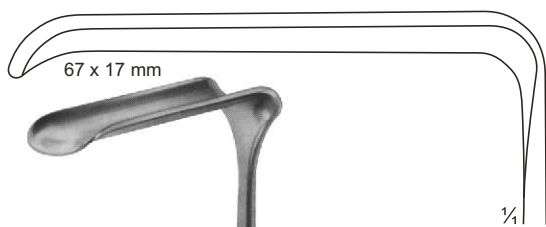

67 x 17 mm

1/2
08-321
CASPAR
210 mm

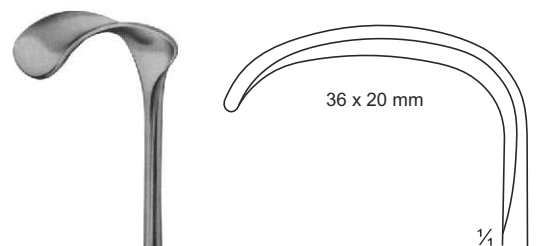

36 x 20 mm

1/2
08-322
KOCHER
230 mm

Retractors



½
08-323 - 328
HOSEL
250 mm

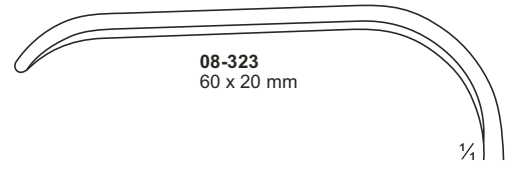

08-323
60 x 20 mm

¼

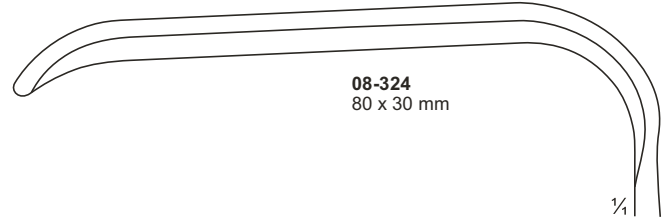

08-324
80 x 30 mm

¼

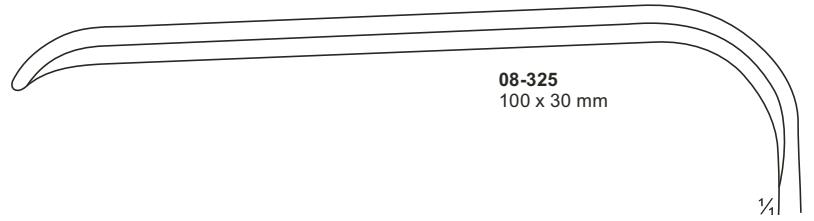

08-325
100 x 30 mm

¼

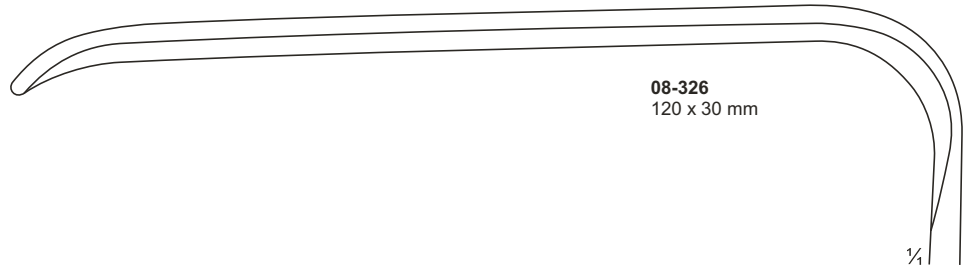

08-326
120 x 30 mm

¼

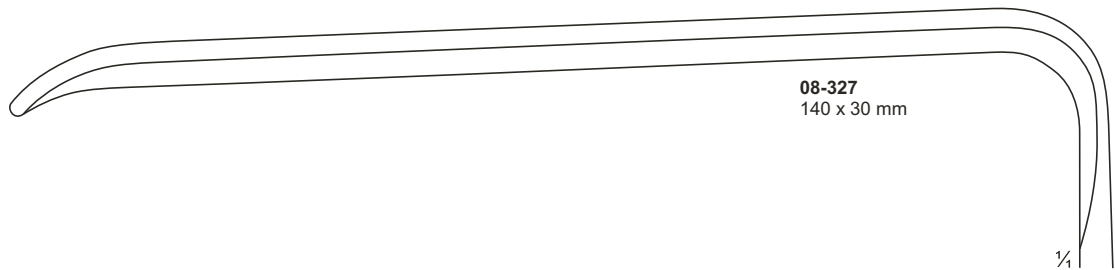

08-327
140 x 30 mm

¼

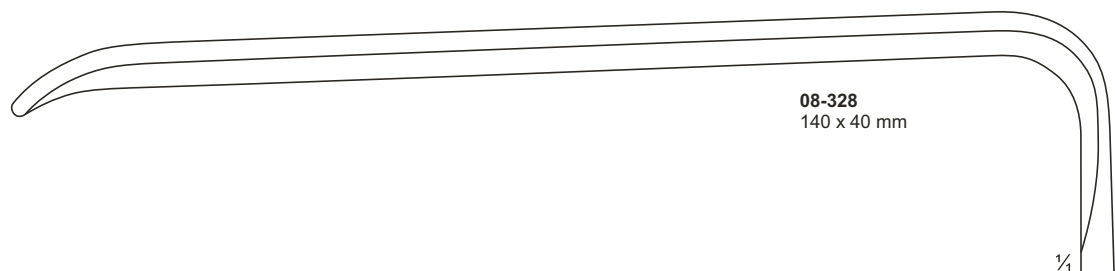

08-328
140 x 40 mm

¼

Retractors

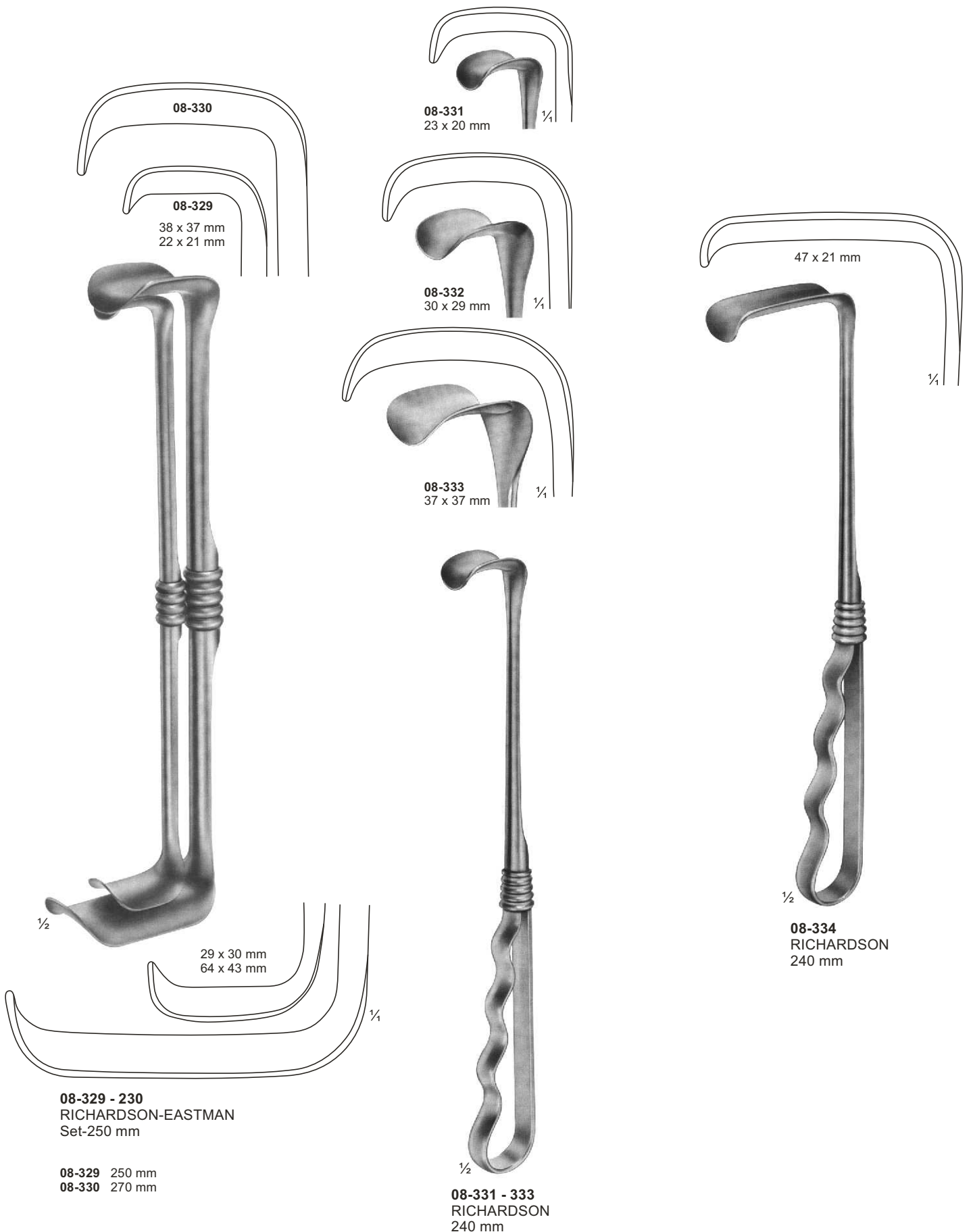

Retractors

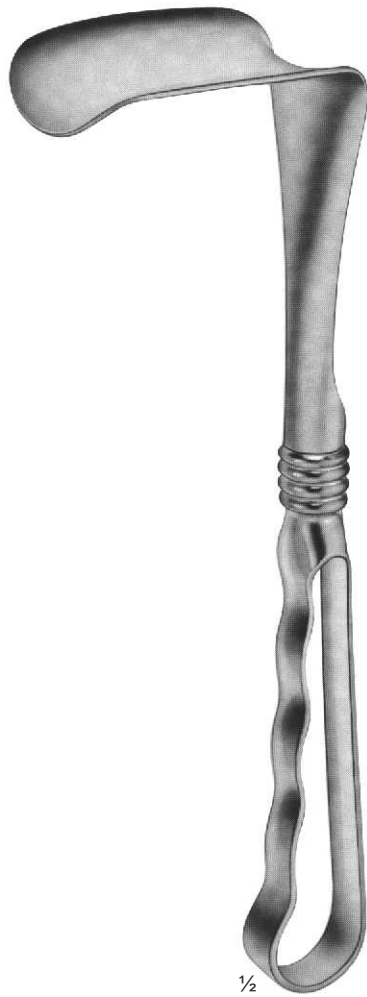
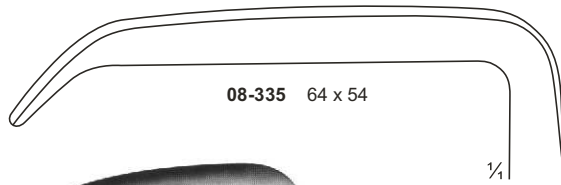
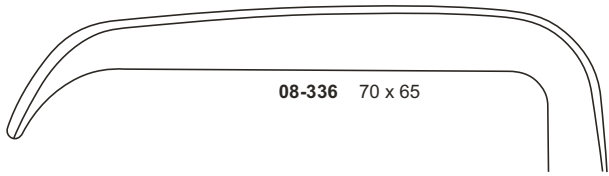

08-335 - 336
KELLY
260 mm

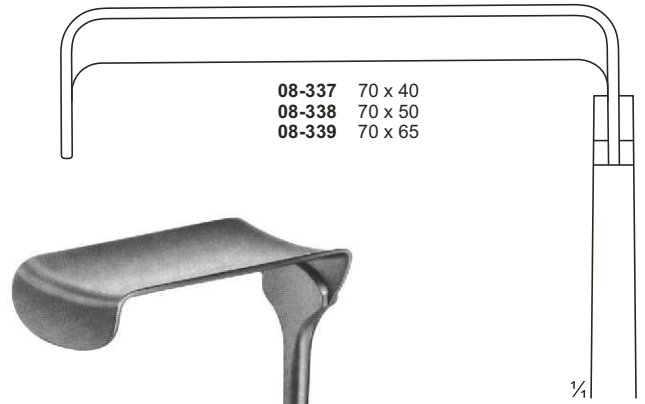

08-337 - 339
MORRIS
245 mm

Retractors For Deep Surgery



Retractors For Deep Surgery

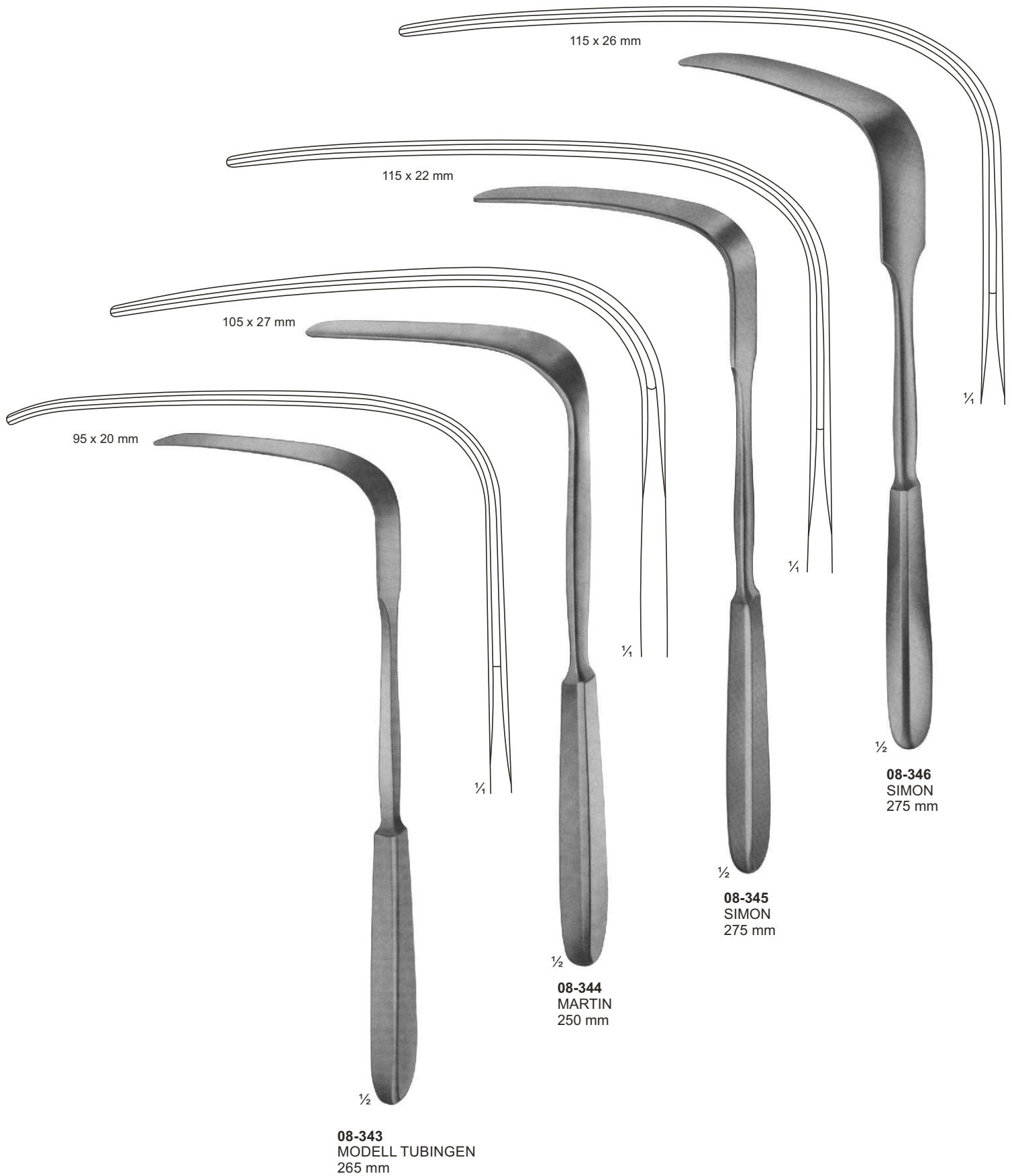

**Vario Retractor System, Germ. Fed. Patent,
Germ. Fed. Regd.Des.**



- 08-347 - 353**
BRUNNER
275 mm
- 08-347** 80 x 20
 - 08-348** 100 x 25
 - 08-349** 120 x 25
 - 08-350** 130 x 30
 - 08-351** 140 x 30
 - 08-352** 160 x 30
 - 08-353** 180 x 30

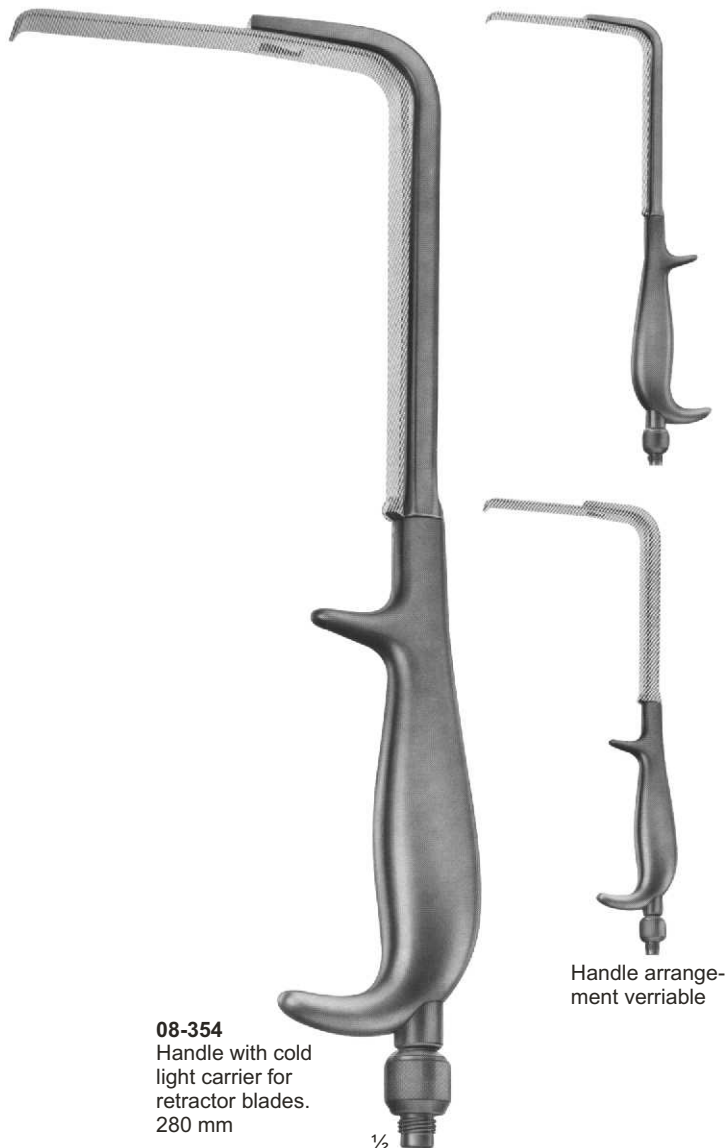

Retractors, Lung Spatulas

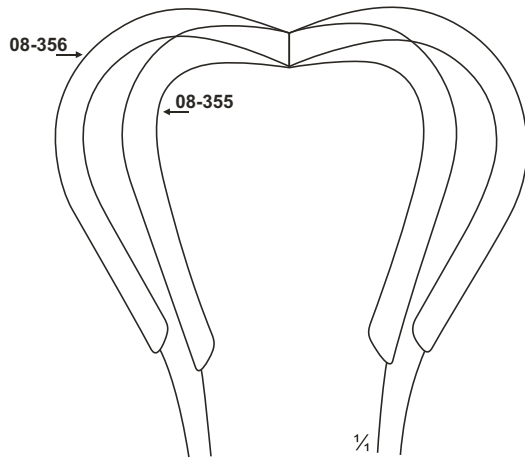

08-355 - 356
HARRINGTON
08-355 123 x 45 mm
08-356 123 x 64 mm
 Flexible
 295 mm



08-357
ALLISON
 255 mm

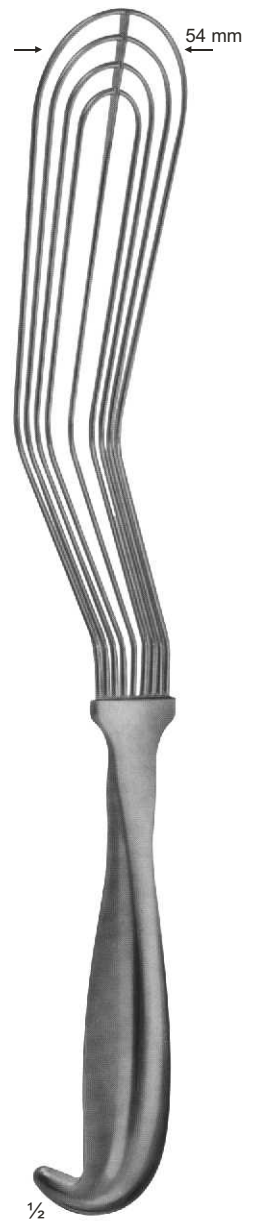

08-358
ALLISON
 320 mm

Retractors, Lung Spatulas



Retractors, Lung Spatulas



08-364
DEAVER
300 mm
Fig. 1

08-365
DEAVER
315 mm
Fig. 2

08-366
DEAVER
365 mm
Fig. 2

Retractors, Lung Spatulas



08-367
DEAVER
300 mm
Fig. 3

08-368
DEAVER
310 mm
Fig. 4

08-369
DEAVER
320 mm
Fig. 5

Retractors, Lung Spatulas

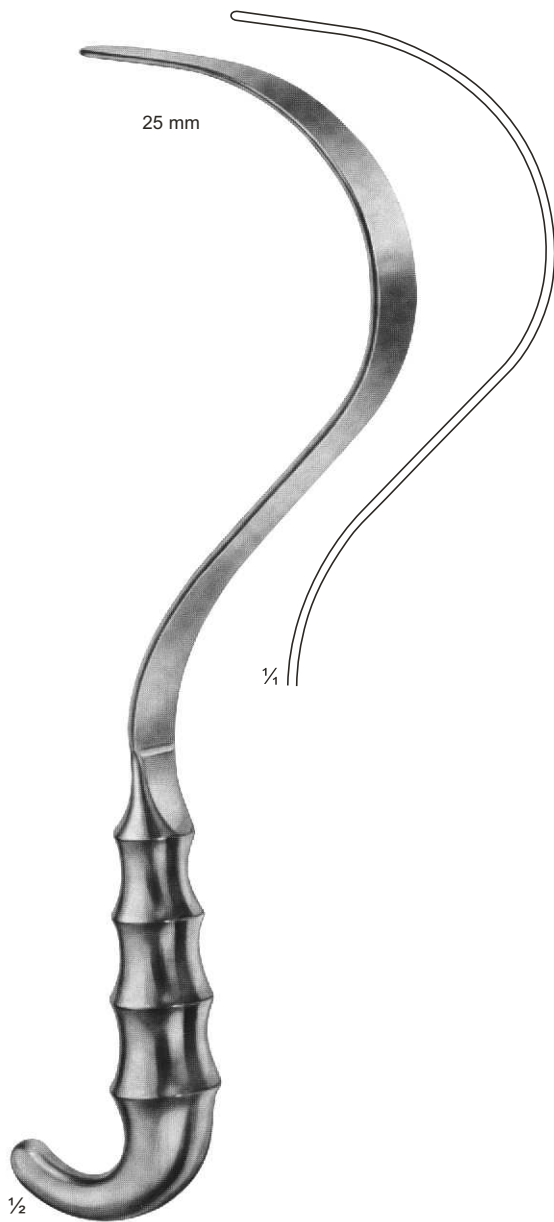

08-370
DEAVER
310 mm
Fig. 1



08-371
DEAVER
310 mm
Fig. 3

Retractors, Lung Spatulas



08-372
DEAVER
305 mm
Fig. 3



08-373
DEAVER
310 mm
Fig. 4

Retractors For Deep Surgery (Abdominal Retractors)



08-374
MIKULICZ
255 mm

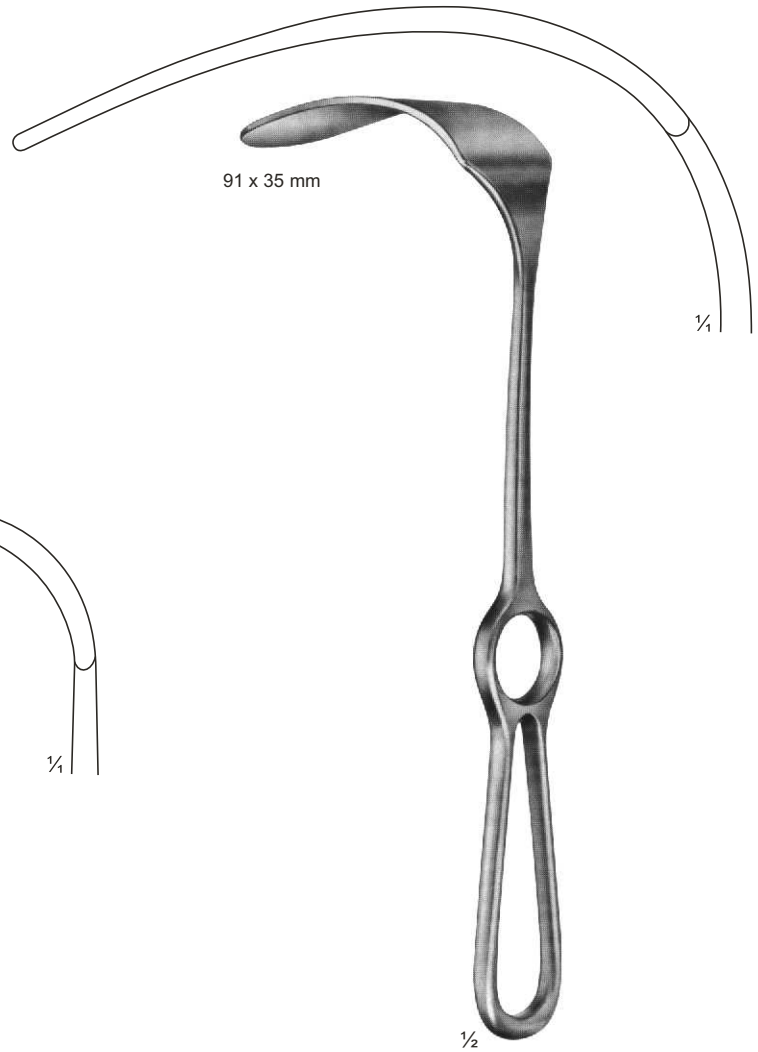

08-375
MIKULICZ
250 mm

Retractors For Deep Surgery (Abdominal Retractors)

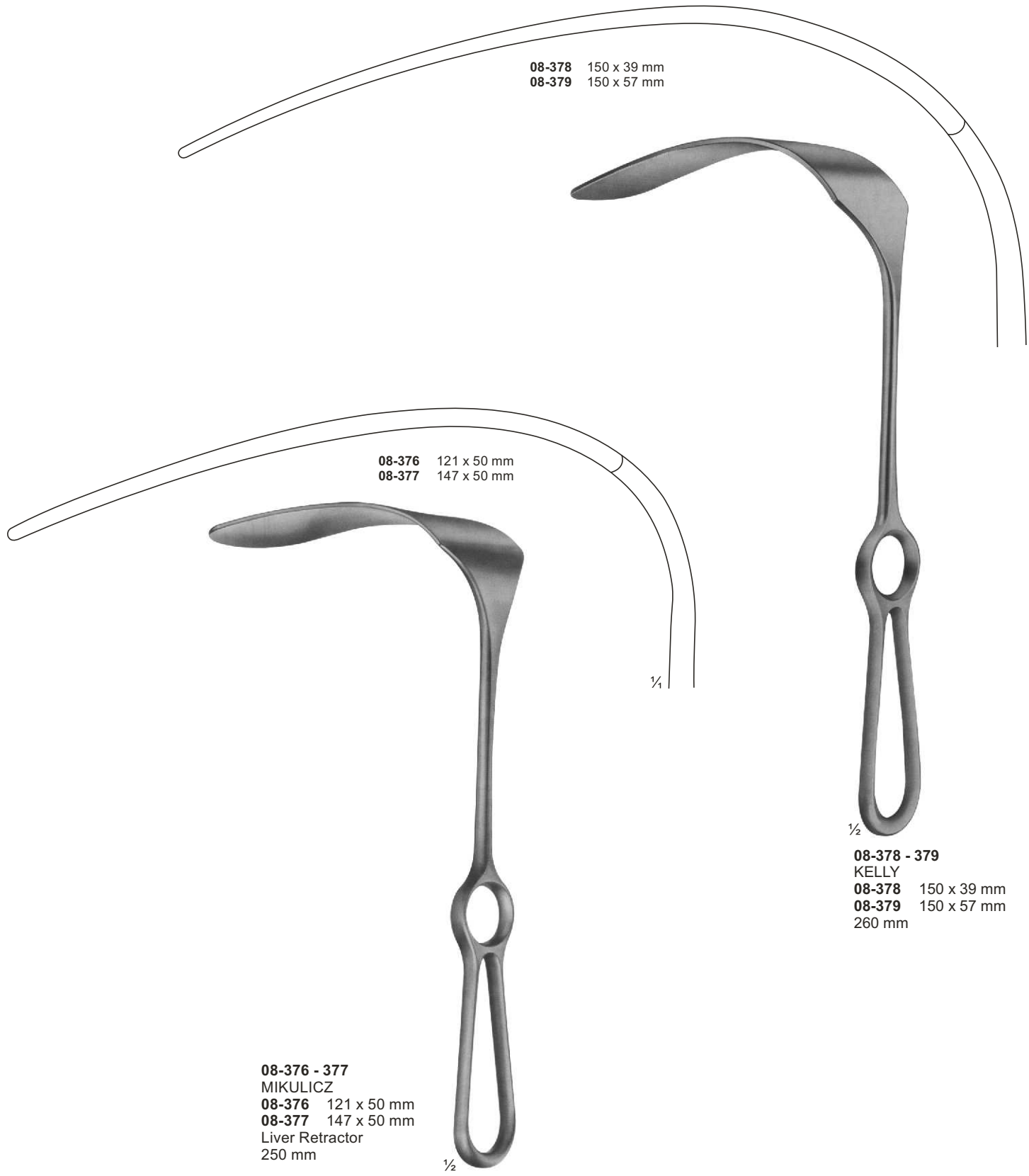

08-378 150 x 39 mm
 08-379 150 x 57 mm

08-376 121 x 50 mm
 08-377 147 x 50 mm

08-378 - 379
 KELLY
 08-378 150 x 39 mm
 08-379 150 x 57 mm
 260 mm

08-376 - 377
 MIKULICZ
 08-376 121 x 50 mm
 08-377 147 x 50 mm
 Liver Retractor
 250 mm

Retractors, Abdominal Retractors

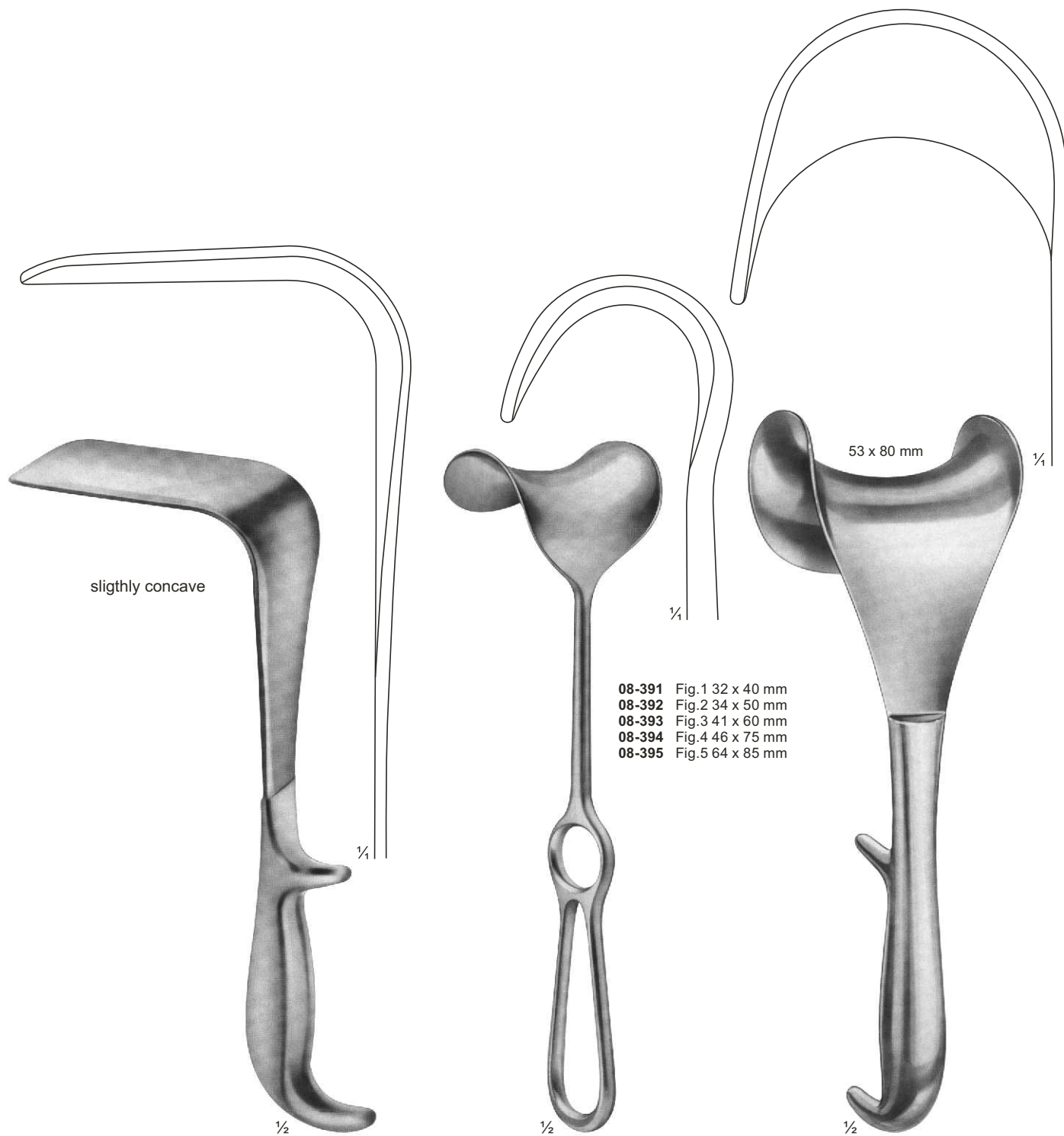

08-380 - 390
DOYEN
240 mm

08-391 - 395
FRITSCH
240 mm

08-396
DOYEN
250 mm

- 08-391 Fig.1 32 x 40 mm
- 08-392 Fig.2 34 x 50 mm
- 08-393 Fig.3 41 x 60 mm
- 08-394 Fig.4 46 x 75 mm
- 08-395 Fig.5 64 x 85 mm

Width of Blades
35 mm, 45 mm, 60 mm

Length of Blades
62 mm 08-380, 08-381, 08-382
92 mm 08-383, 08-384, 08-385
122 mm 08-386, 08-387, 08-388
160 mm 08-389, 08-390

Abdominal Retractors

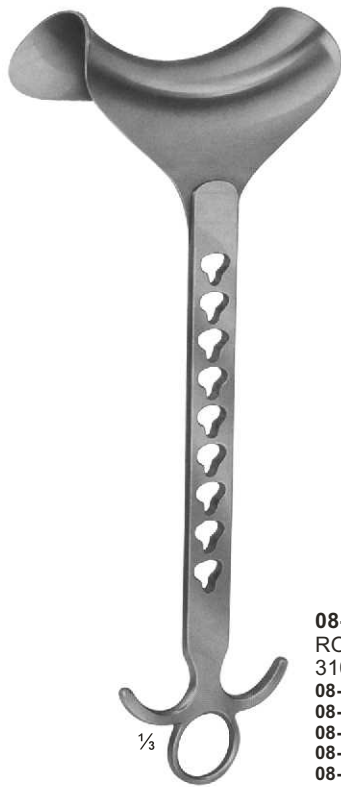

08-397 - 401
ROCHARD
 310 mm
08-397 48 x 90 mm
08-398 48 x 105 mm
08-399 48 x 120 mm
08-400 48 x 135 mm
08-401 48 x 155 mm



08-402



08-403 - 406
DOYEN
 280 mm
08-403 48 x 90 mm
08-404 48 x 105 mm
08-405 48 x 120 mm
08-406 48 x 135 mm



08-407
DOYEN-CHILD
 Fixation device
 220 mm



08-408
 Chain with
 weight (747 / 645g)
 790 mm

Pelvis Retractors

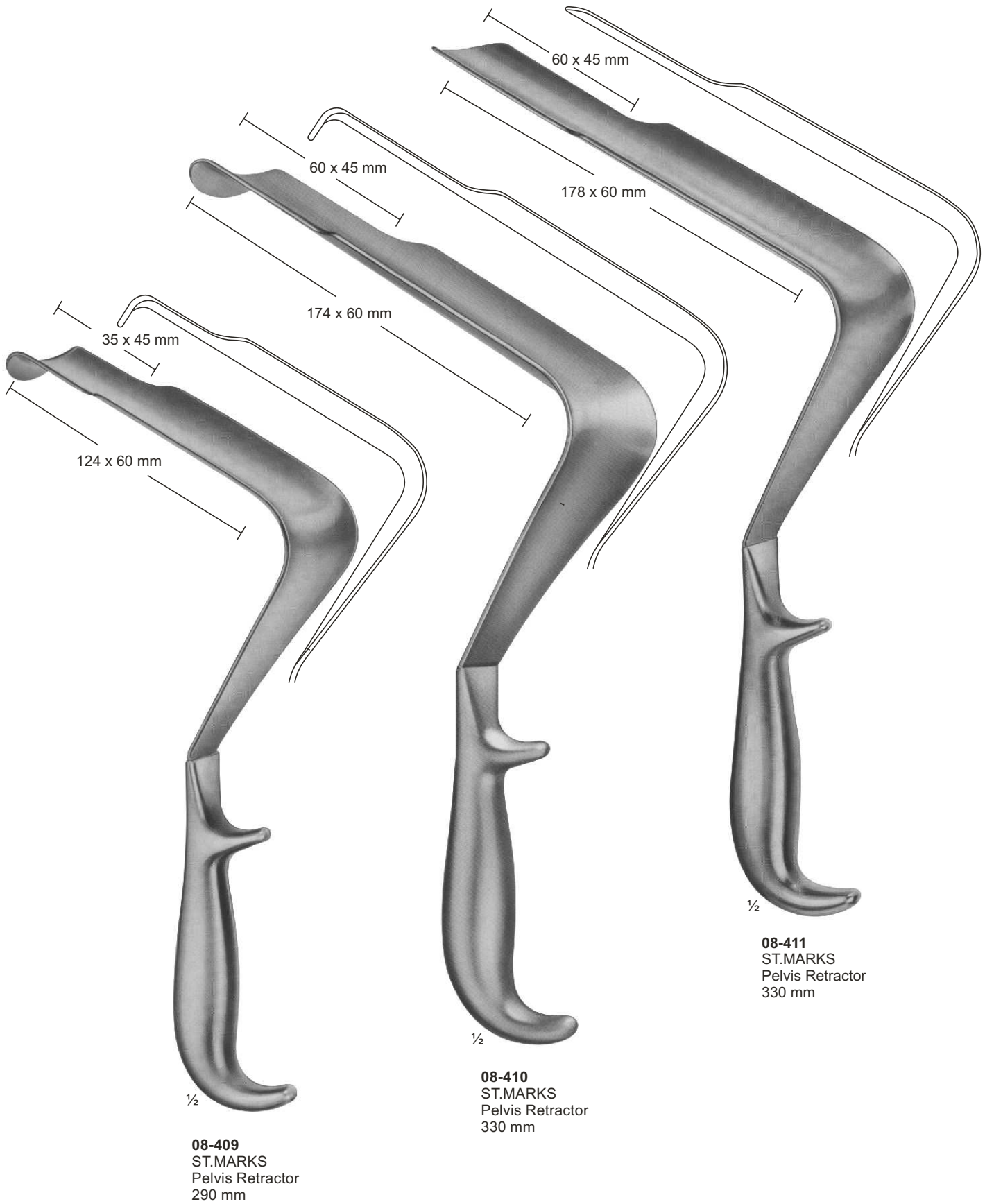

Abdominal- and Intestinal Spatulas



08-412
LERICHE
255 mm

08-413
KUMMEL
Melleable
285 mm

08-414
MIKULICZ
29 mm
250 mm

08-415 - 416
KADER
08-415 30 mm
08-416 40 mm
270 mm

Abdominal- and Intestinal Spatulas



08-417
REVERDIN
285 mm



08-418
HABERER
Malleable
305 mm



08-419 30 mm
08-420 40 mm
08-421 50 mm
Malleable
330 mm



08-422
TUFFIER
Malleable
200 mm

Self-Retaining Retractors



08-423
BOSE
60 mm



08-424
FINSEN
50 mm



08-425
FINSEN
70 mm



08-426
FINSEN modif.
75 mm



08-427
45 mm



08-428
55 mm



08-429
MUELLER
65 mm



08-430
100 mm



08-431



08-432



08-431 - 432
ALM
08-431 70 mm
08-432 100 mm

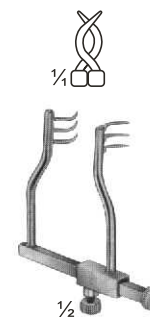

08-433
LOGAN
modif. REILL
50 mm

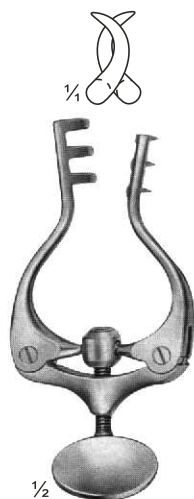

08-434
JANSEN
100 mm

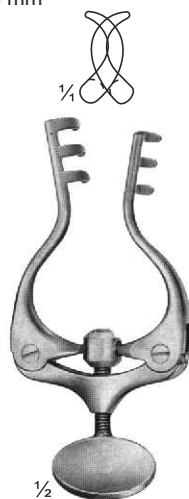

08-435
JANSEN
100 mm

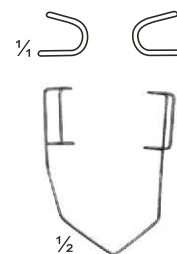

08-436
BARRAQUER
45 mm

Self-Retaining Retractors



08-437
WEITLANER
Sharp
110 mm

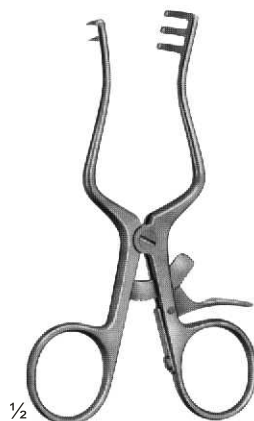

08-438
WEITLANER
Semi-Sharp
110 mm

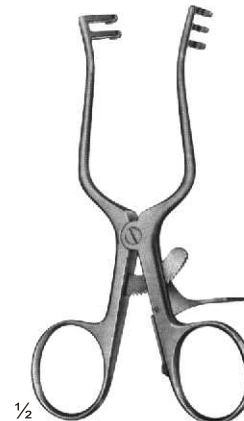

08-439
WEITLANER
Blunt
110 mm



08-440
WEITLANER
Sharp
130 mm



08-441
WEITLANER
Semi-Sharp
130 mm

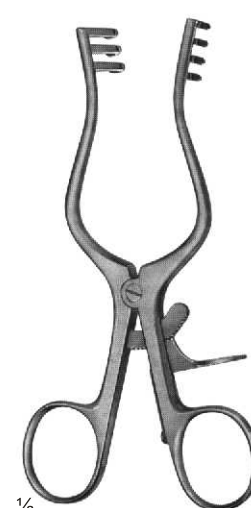

08-442
WEITLANER
Blunt
130 mm

Self-Retaining Retractors

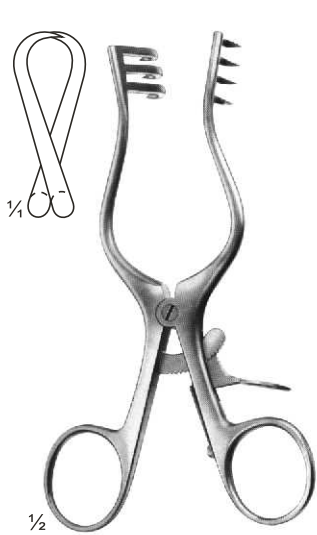

08-443
WEITLANER
Sharp
130 mm

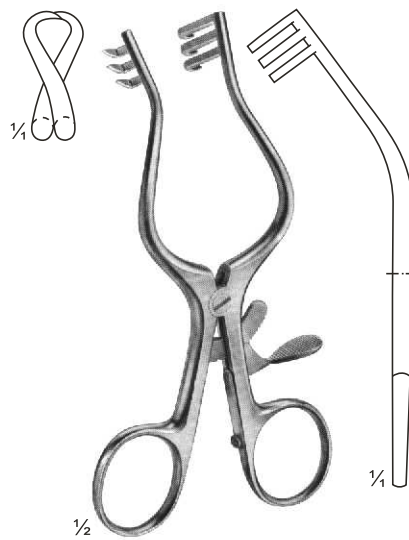

08-444
WULLSTEIN
Sharp
130 mm

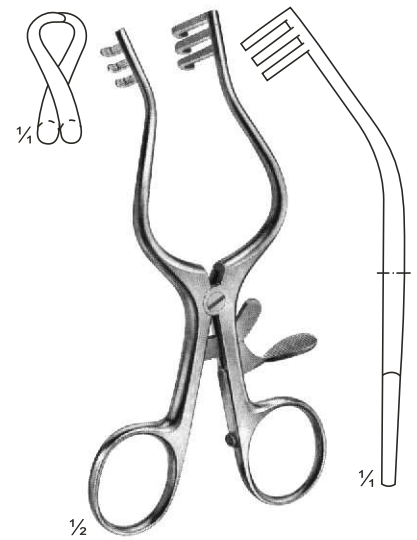

08-445
WULLSTEIN
Blunt
130 mm

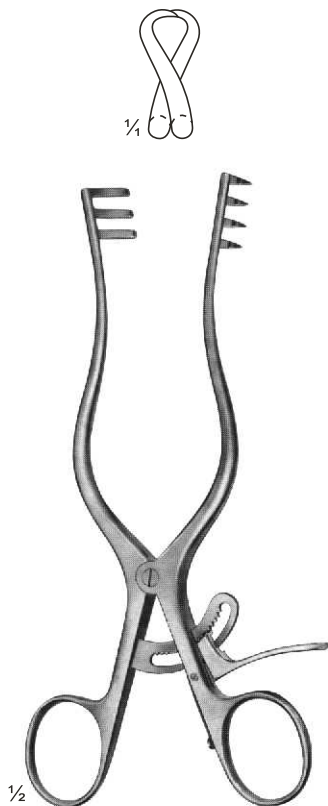

08-446
WEITLANER
Sharp
165 mm



08-447
PLESTER
Blunt
110 mm

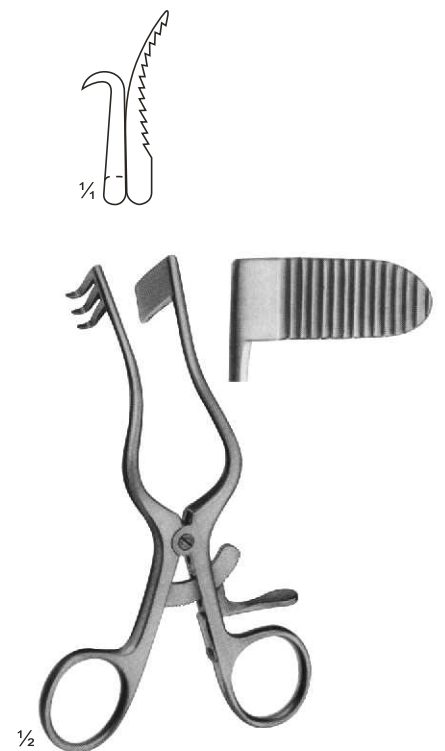

08-448
PERKINS
130 mm

Self-Retaining Retractors



08-449
ADSON-BABY
Blunt
140 mm

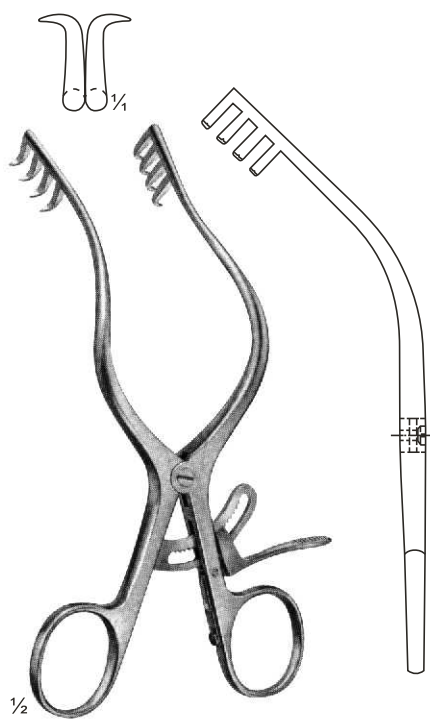

08-450
MOLLISON
Sharp
155 mm



08-451
MAYO-ADAMS
165 mm

Self-Retaining Laminectomy Retractors

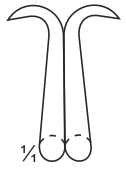

08-452
ANDERSON-ADSON
Sharp
190 mm



08-453
NORFOLK and
NORWICH
Blunt
220 mm



08-454
ADSON
Sharp
265 mm

Self-Retaining Laminectomy Retractors

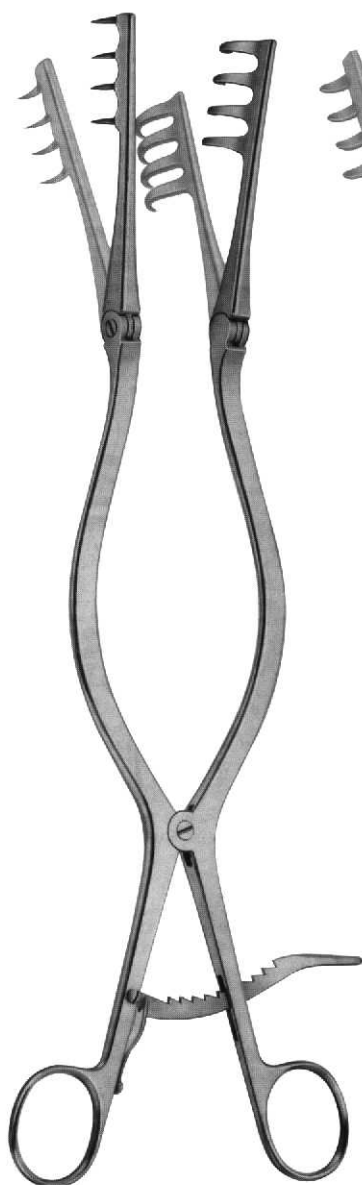
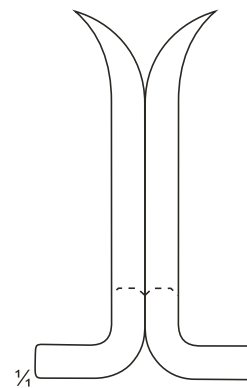
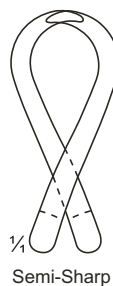
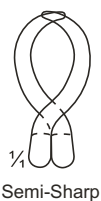
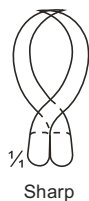

08-455 - 456
BECKMANN-ADSON
Sharp
310 mm



08-456
BECKMANN-ADSON
Semi-Sharp
310 mm



08-457
ADSON
Semi-Sharp
320 mm



08-458
BECKMANN-EATON
Sharp
320 mm

Special Retractors



1/2

08-459
JOLL (FRIEDMAN)
Thyroid- and Vaginal Retractor
155 mm

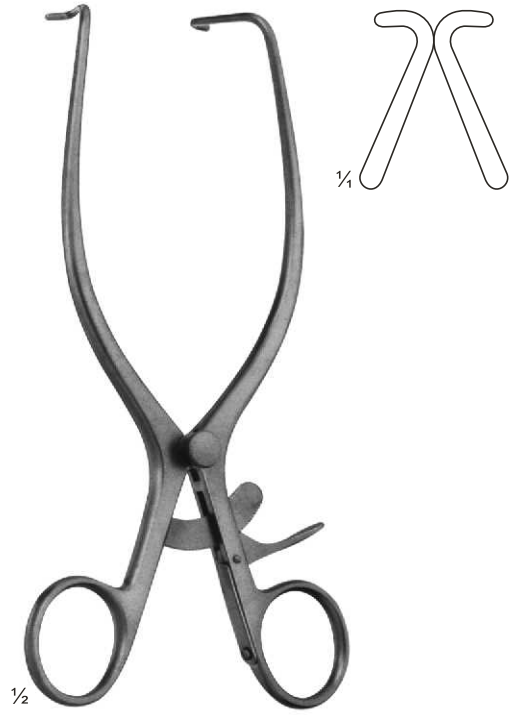

1/2

08-460
JACKSON BURROWS
Retractor, blunt
185 mm

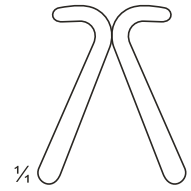

1/4

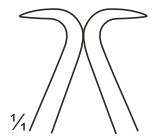

1/4



1/2

08-461
GELPI
Vaginal Retractor
135 mm

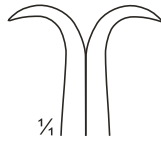

1/4



1/2

08-462
GELPI
Skin- and Vaginal Retractor
175 mm

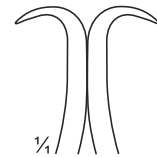

1/4



1/2

08-463
DE BAKEY
Femur Retractor
145 mm

Self Retaining Retractors for Laminectomy and other Operations

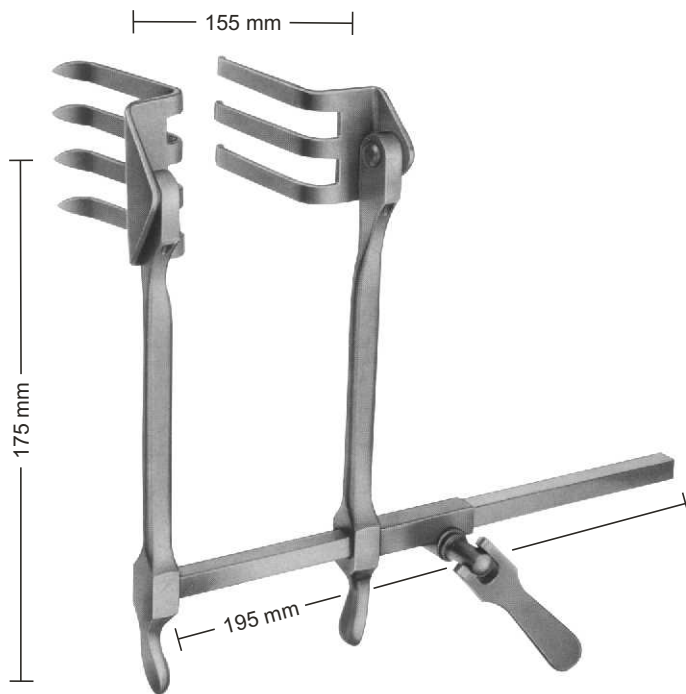

08-464 - 468
SCOVILLE-RICHTER
 Retractor with 1 pair
 blades reversible type.
 The Retractor bar and
 shanks may be easily
 rotated 180° when
 blades are in situ.



08-465
 62 x 52 mm 62 x 37 mm
 PR= Pair



08-466
 47 x 51 mm



08-467
 30 x 40 mm



08-468
 37 x 62 mm

Retractors for Cervical Spine



08-469
CLOWARD modif.
Spreader Only



16 mm
08-470

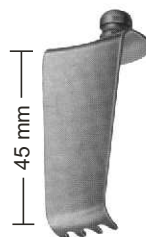

16 mm
08-471



16 mm
08-475



16 mm
08-476

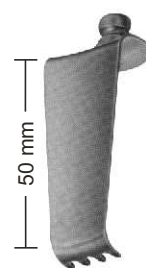

16 mm
08-472

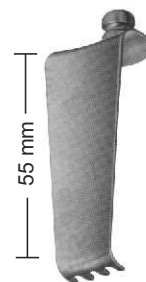

16 mm
08-473

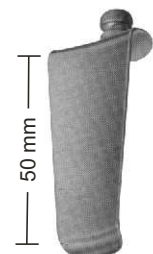

16 mm
08-477

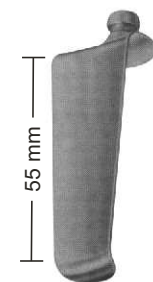

16 mm
08-478

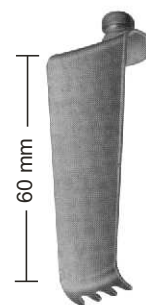

16 mm
08-474

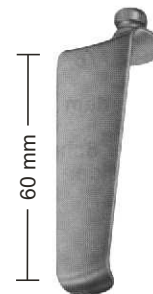

16 mm
08-479

08-470 blade
08-471 blade
08-472 blade
08-473 blade
08-474 blade

08-475 blade
08-476 blade
08-477 blade
08-478 blade
08-479 blade

Retractors for Cervical Vertebral Column

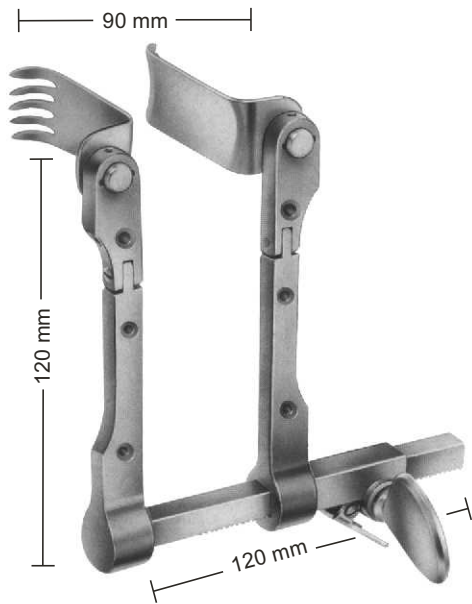

08-480
CASPAR
Retractor, adjustable,
consisting of: 5 medial
blades, 5 Lateral blades.

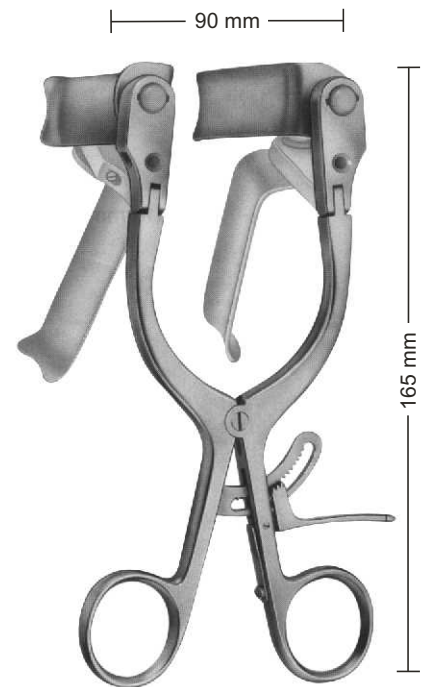

08-480 A
CASPAR
Counter retractor, adjustable,
consisting of: 5 blades.



08-481 40 x 23 mm
08-482 45 x 23 mm
08-483 50 x 23 mm
08-484 55 x 23 mm
08-485 60 x 23 mm
Medial blades



08-486 40 x 23 mm
08-487 45 x 23 mm
08-488 50 x 23 mm
08-489 55 x 23 mm
08-490 60 x 23 mm
Lateral blades



08-491 45 x 23 mm
08-492 50 x 23 mm
08-493 55 x 23 mm
08-494 60 x 23 mm
08-495 65 x 23 mm
Blunt blades



08-496 50 x 25 mm
08-497 60 x 25 mm
Blunt blades,
for harvesting of the
fusion graft from the
iliac crest



08-498 40 x 25 mm
08-499 45 x 25 mm
08-500 50 x 25 mm
08-501 55 x 25 mm
08-502 60 x 25 mm
Medial Titan blades
semi transparent to x-ray

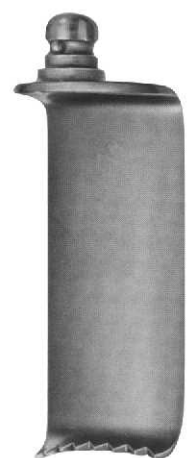

08-503 40 x 25 mm
08-504 45 x 25 mm
08-505 50 x 25 mm
08-506 55 x 25 mm
08-507 60 x 25 mm
Lateral Titan blades
semi transparent to x-ray

Lamina Spreaders



08-508
CLOWARD
155 mm



08-509
CLOWARD
135 mm

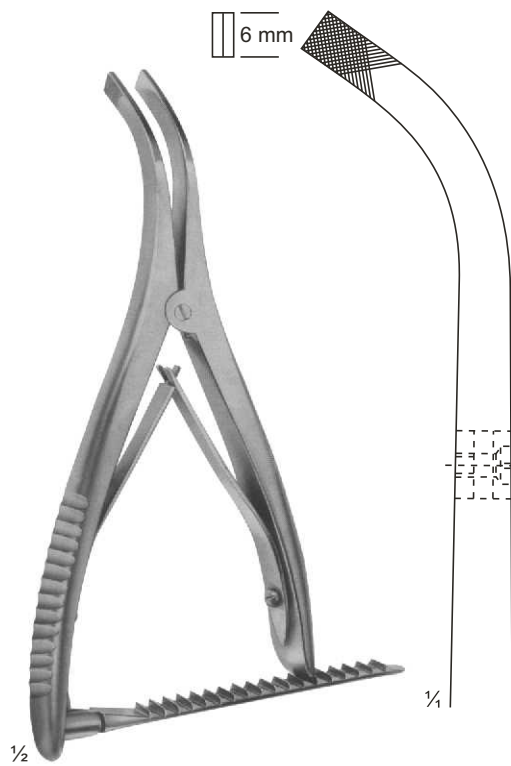

08-510
INGE
170 mm

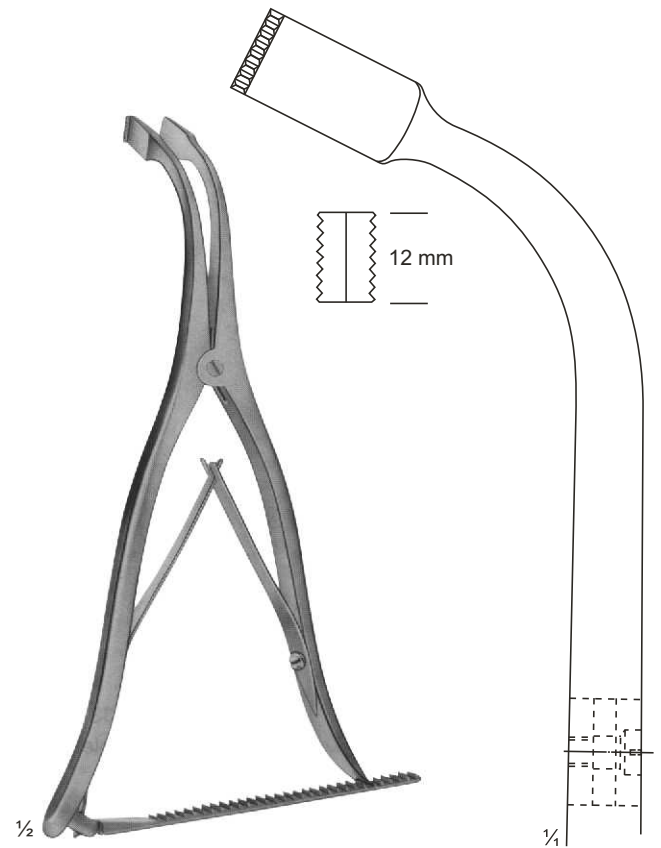

08-511
INGE
275 mm

Abdominal Retractors

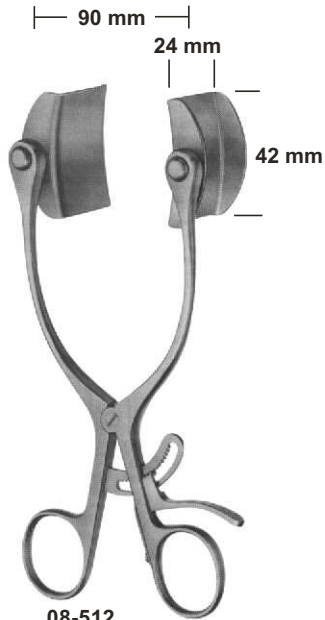

08-512
BABY-COLLIN
with 2 pair of blades

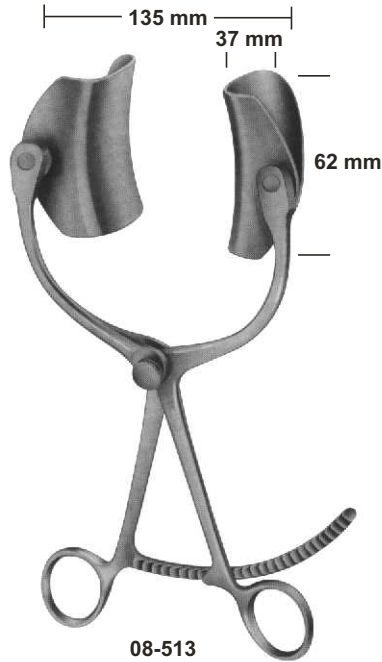

08-513
COLLIN
complete

08-817 135 mm
08-818 160 mm

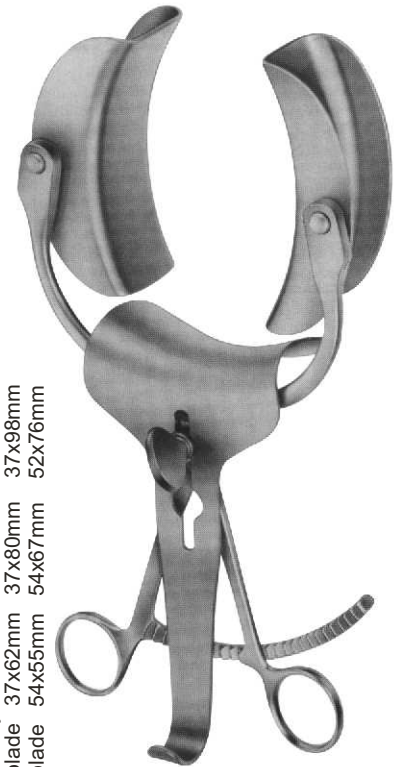

08-516 37x98mm
08-515 37x80mm
08-514 37x62mm
08-518 54x67mm
08-514 54x55mm

08-514 - 518
COLLIN
complete

210 mm



08-519 - 520
RICARD
complete

Spreader only **08-519** **08-520**
Lateral blade 58x80mm 72x84mm
Canter blade 54x70mm 72x90mm

275 mm



08-521 - 523
HOLZBACH
Complete

08-521 Spreader only
08-522 Lateral blade 59x80mm
08-523 Canter blade 74x82mm

Abdominal Baldes

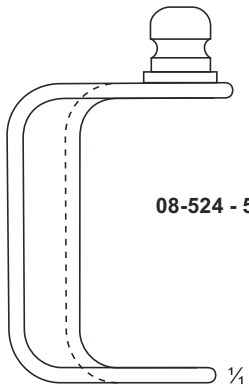

08-524 - 526

Lateral blades only
08-524 37x62 mm
08-525 37x80 mm
08-526 37x98 mm

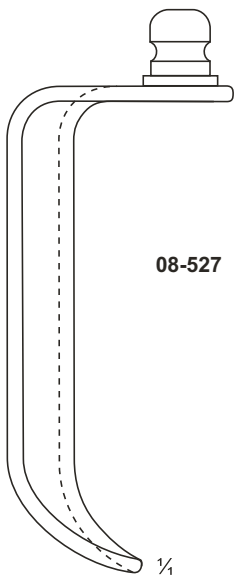

08-527

08-527 61x80 mm

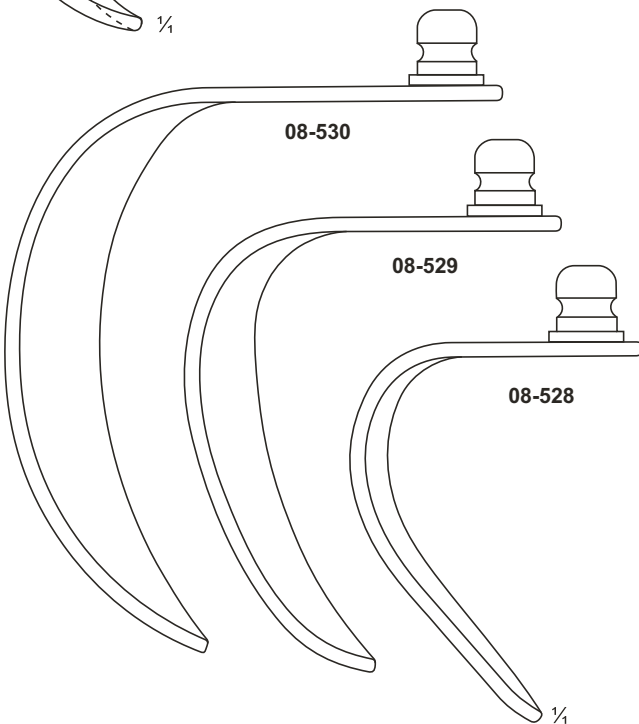

08-530

08-529

08-528

08-528 48x59 mm
08-529 58x80 mm
08-530 72x84 mm

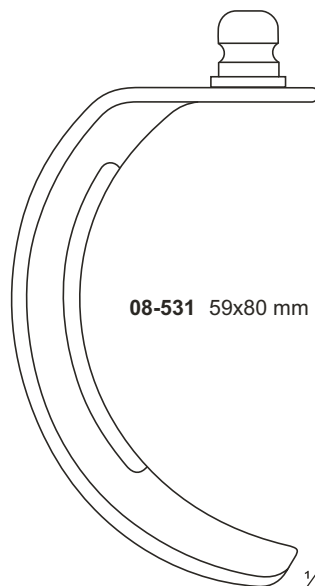

08-531 59x80 mm

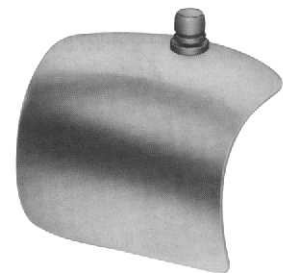

Abdominal Retractors

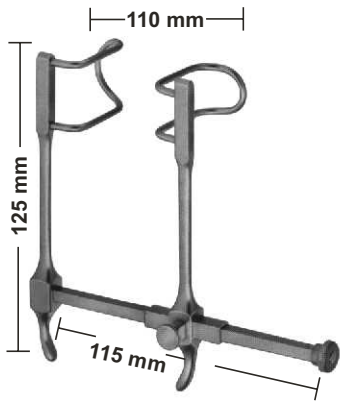

08-532
GOSSET
Blades:38 mm deep

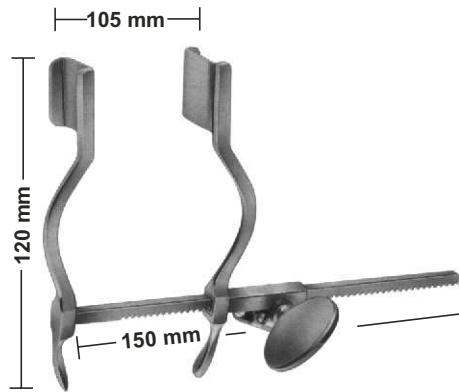

08-533
HERTZLER
Blades 20 X 25 mm

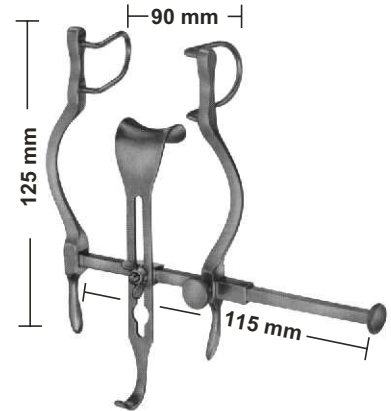

08-534
BALFOUR-BABY
Lateral blades 27 mm deep
Center blade 21x24 mm

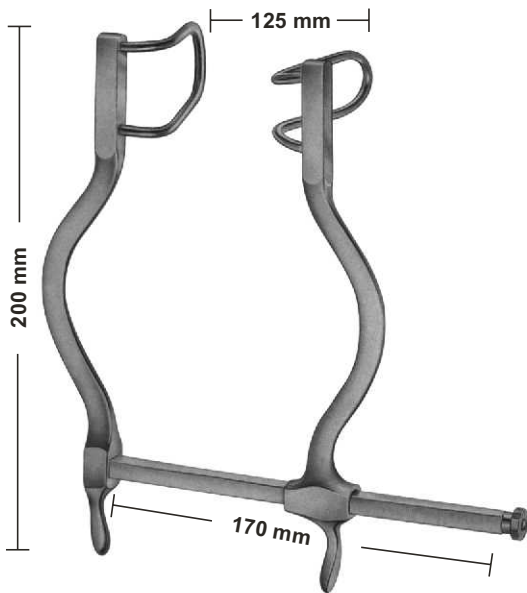

08-535
GOSSET
Blades:55mm deep

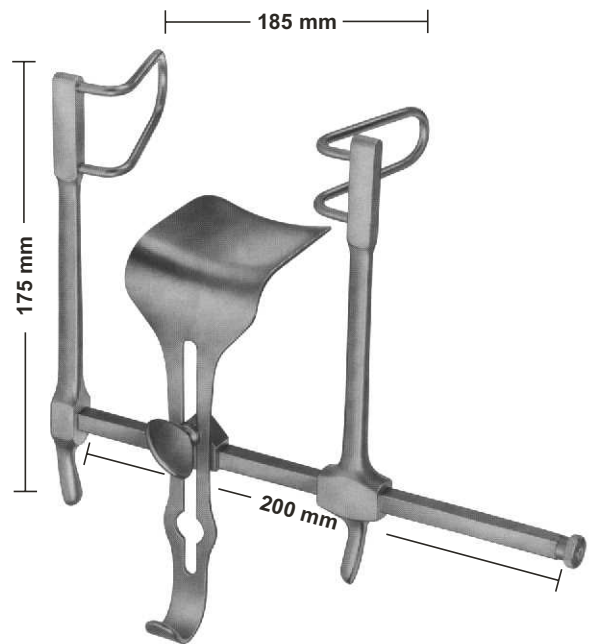

08-536
GOSSET
Lateral blades 58 mm deep
Center blade 59 x 57 mm

Abdominal Retractors

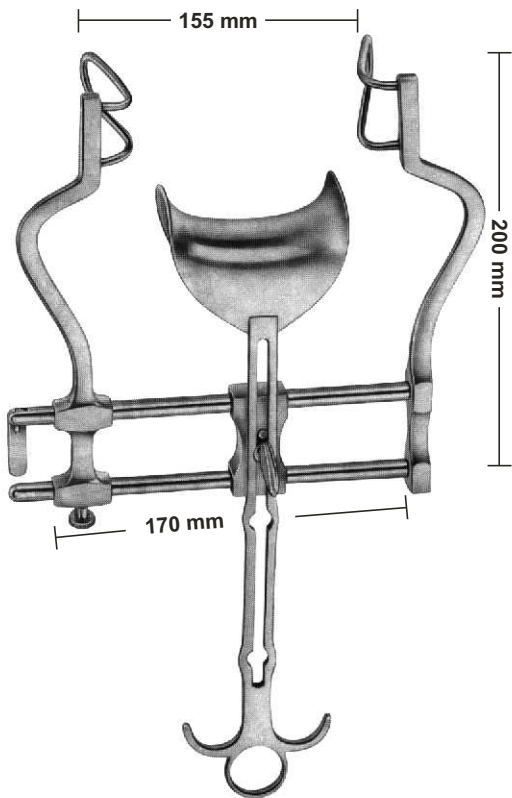

08-537
BALFOUR
Lateral blades 60 mm deep
Center blade 47 x 80 mm

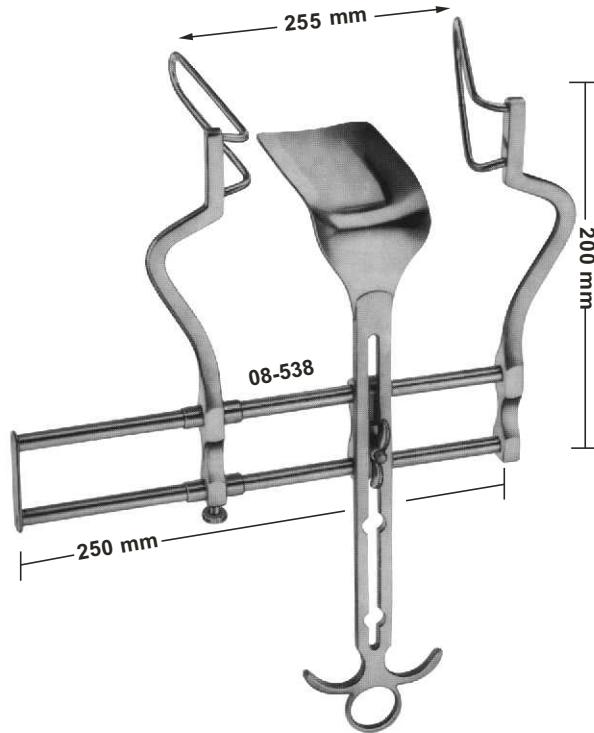

08-538
BALFOUR
Lateral blades 105 mm deep
Center blade 107x 59 mm

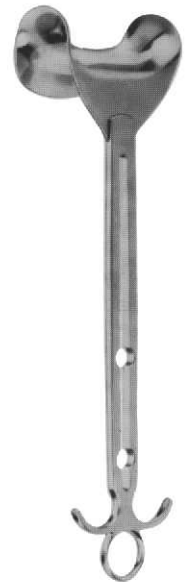

08-539
Center blade only
54x80 mm

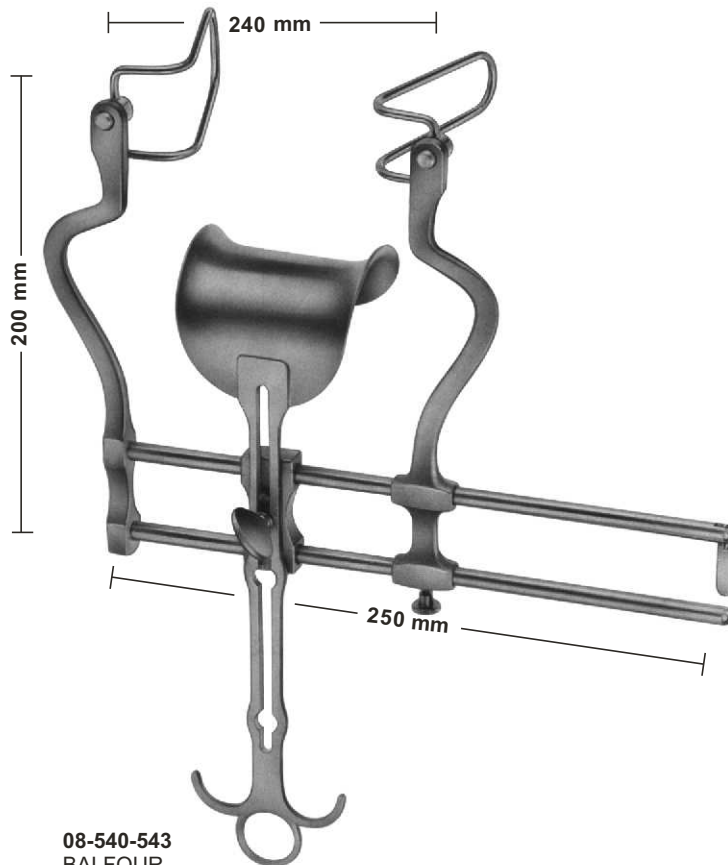

08-540-543
BALFOUR
Spreader only **08-540** **08-541** **08-542** **08-543**
Lateral blades 50 mm 60 mm 75 mm 90 mm
Center blade 47 x 80 mm 62x76 mm 80x80 mm 80x80 mm



Lateral blades
08-544 50 mm deep
08-545 60 mm deep
08-546 75 mm deep
08-547 90 mm deep
Sales Unit of blades: PR = pair

Abdominal Retractors

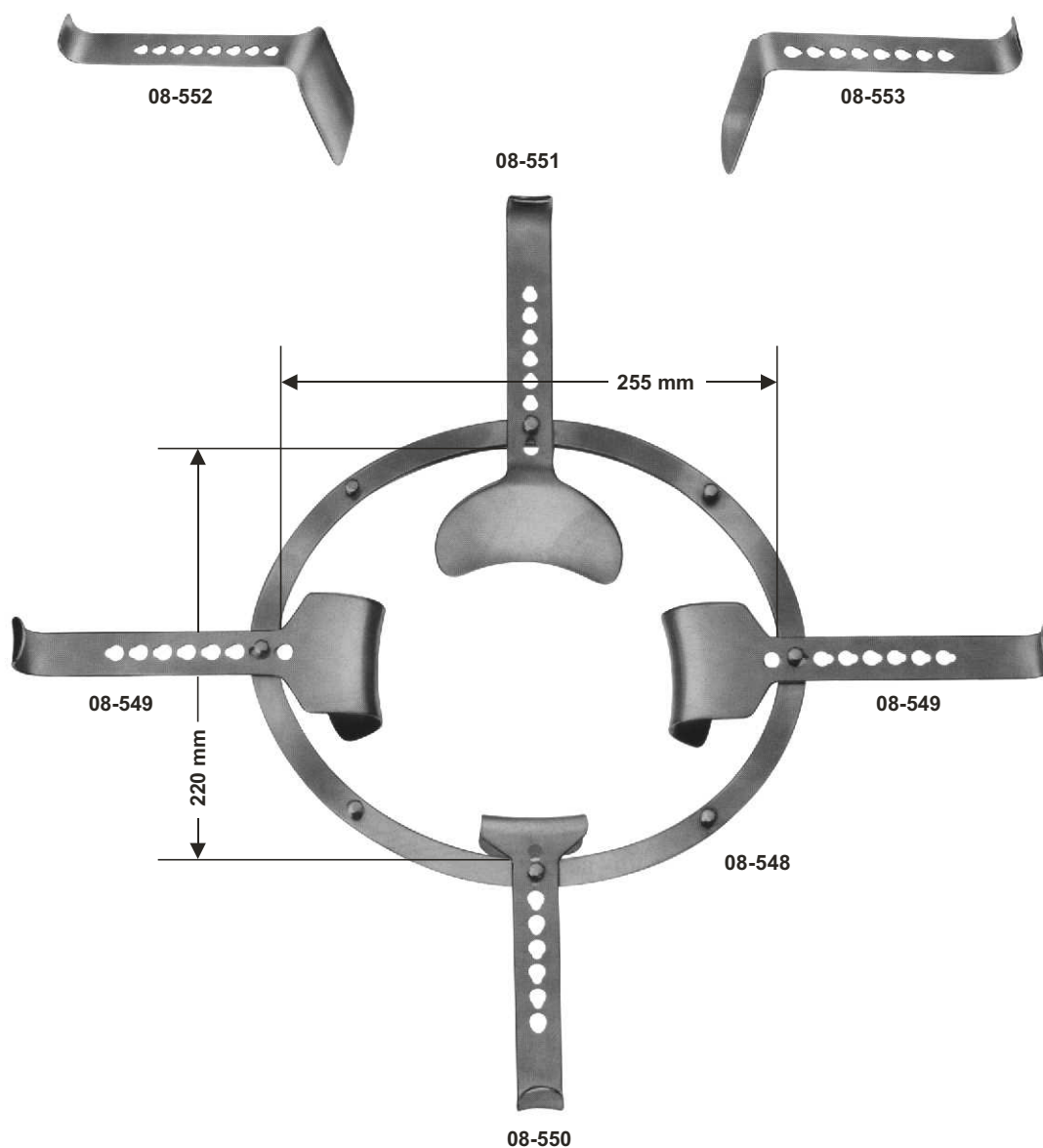

08-548 - 08-553

SEMM

consisting of:

08-548 1 frame 225 x 220 mm

08-549 2 blades 46 x 64 mm

08-550 1 blade 53 x 54 mm
(for bladder)

08-551 1 blade 82 x 97 mm
(for intestine)

08-552 1 blade 98 x 51 mm
(for intestine)

08-553 1 blade, narrow
107 x 36 mm

Abdominal Retractors

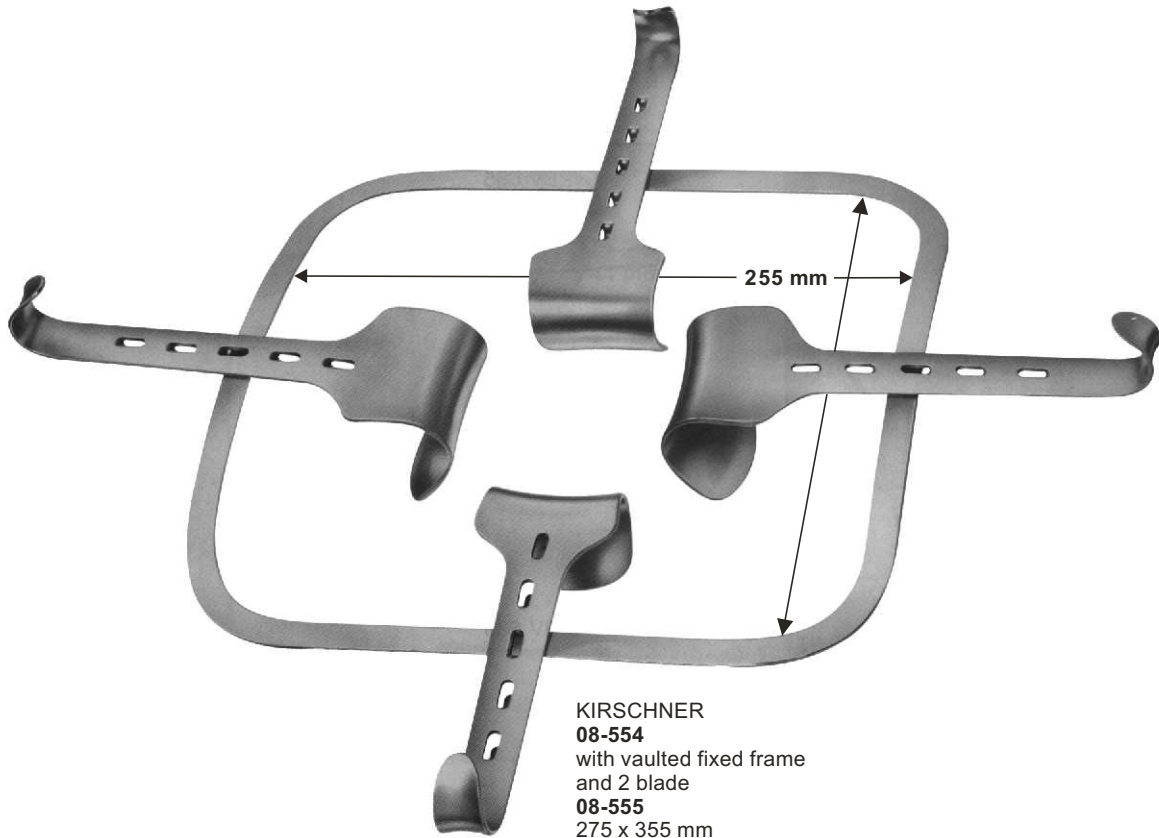

KIRSCHNER
08-554
 with vaulted fixed frame
 and 2 blade
08-555
 275 x 355 mm
 Frame only, over-sized
08-556
 295 x 275 mm
 Frame only



08-557
KIRSCHNER
 64 x 80 mm



08-558
KIRSCHNER-BALFOUR
 80x 82 mm



08-559 - 561
KIRSCHNER
08-559 90x 69mm
08-560 92x 95mm
08-561 78x 58mm



08-562 - 564
KIRSCHNER
08-562 108x42mm
08-563 91x 55mm
08-564 121x 55mm

Intestinal and Tissue Grasping Forceps

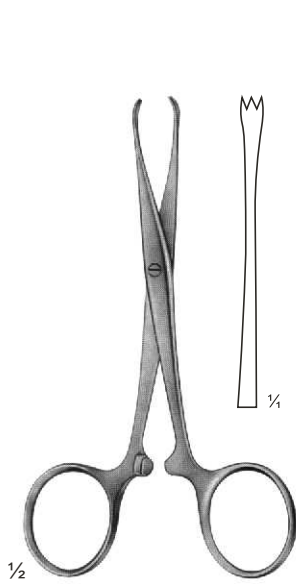

09-101
CHAPUT
 2 X 3 teeth, sharp
 125 mm,

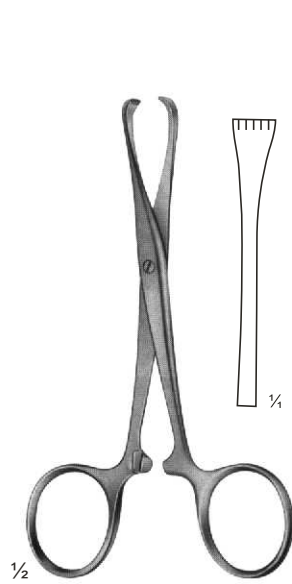

09-102
TUFFIER
 5 X 6 teeth, sharp
 125 mm,

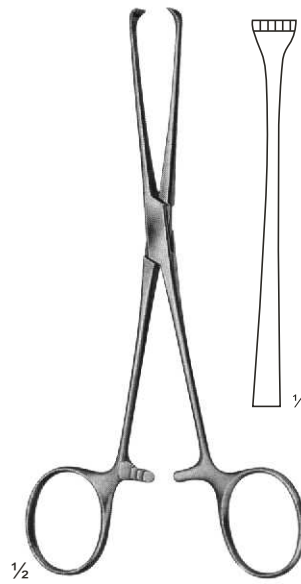

09-103
BOYS-ALLIS
 5 X 6 teeth, sharp
 155 mm,

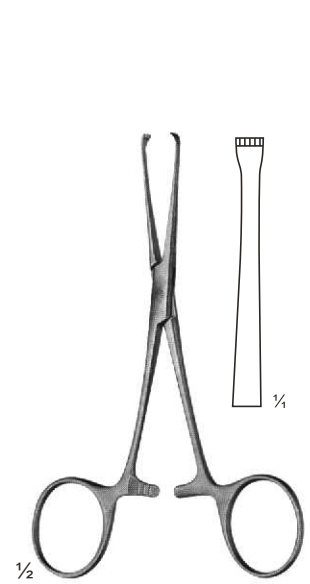

09-104
ALLIS
 4 X 5 teeth
 155 mm,

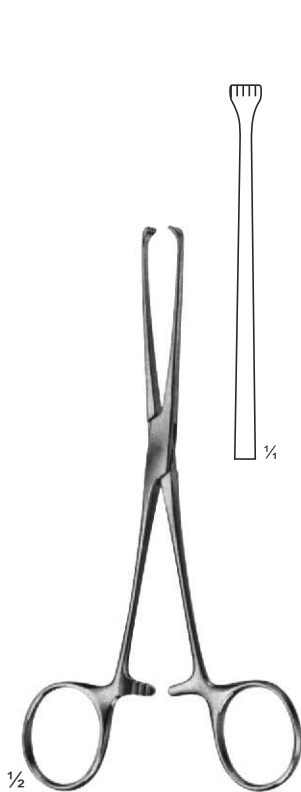

09-105
ALLIS
 155 mm,
 4 X 5 teeth

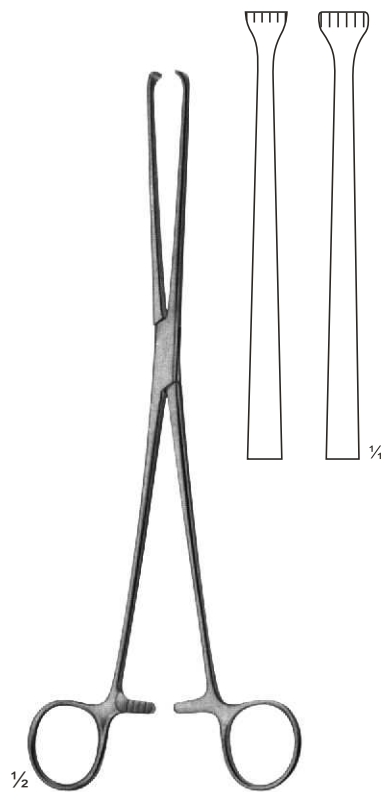

09-106
ALLIS
 190 mm,
09-107
 255 mm,
 5 X 6 teeth

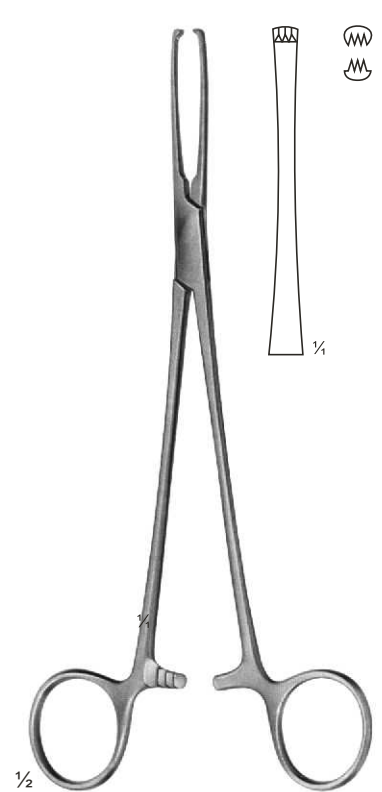

09-108
JUDD-ALLIS
 3 X 4 teeth
 195 mm,

Intestinal Grasping Forceps

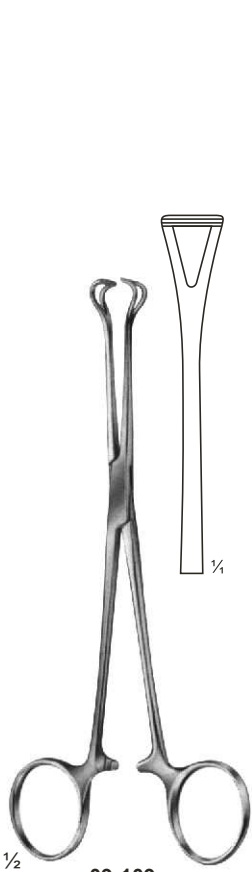

09-109
BABCOCK
155 mm

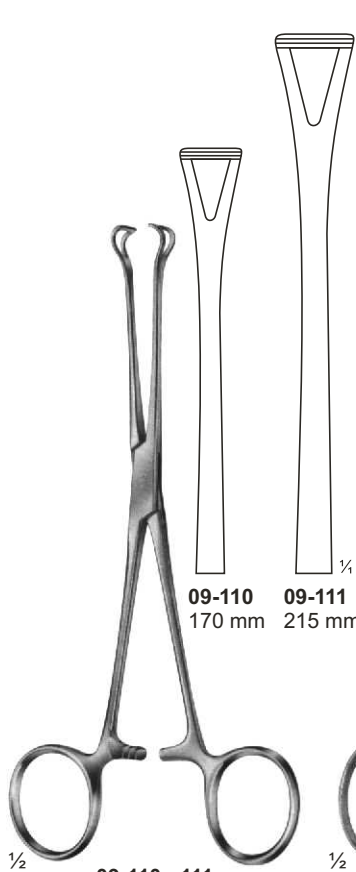

09-110 170 mm
09-111 215 mm

09-110 - 111
BABCOCK

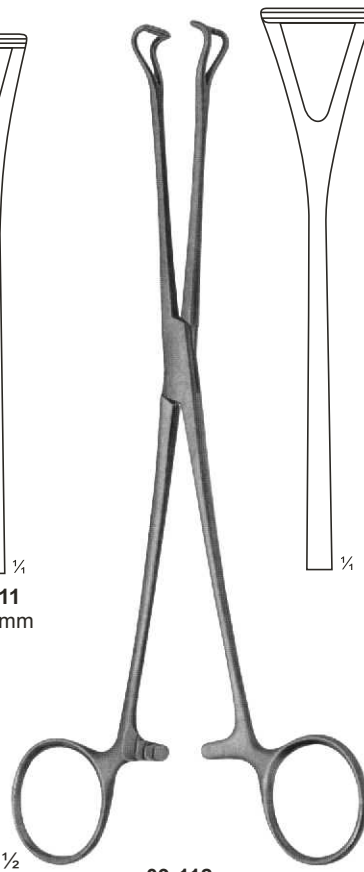

09-112
BABCOCK
220 mm

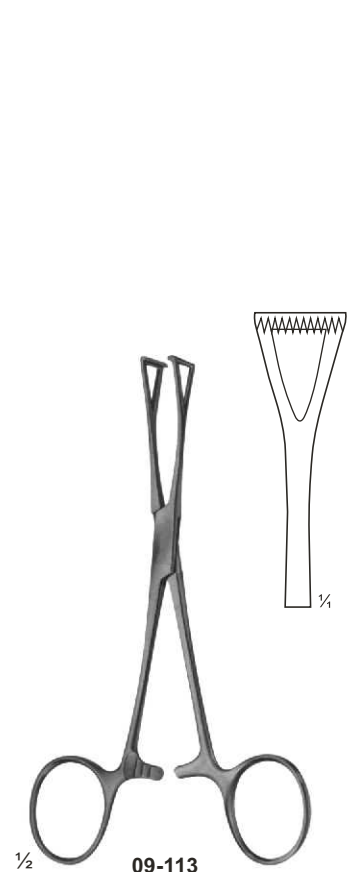

09-113
COLLIN
140 mm,

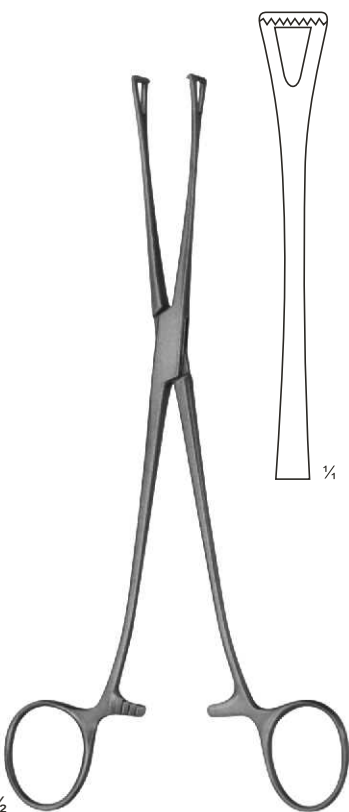

09-114
LOCKWOOD
200 mm,

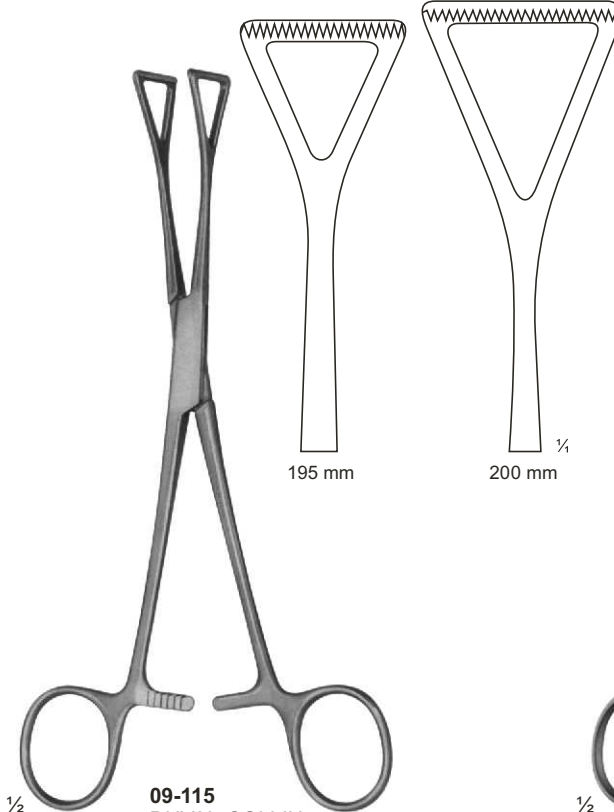

09-115 195 mm
09-116 200 mm

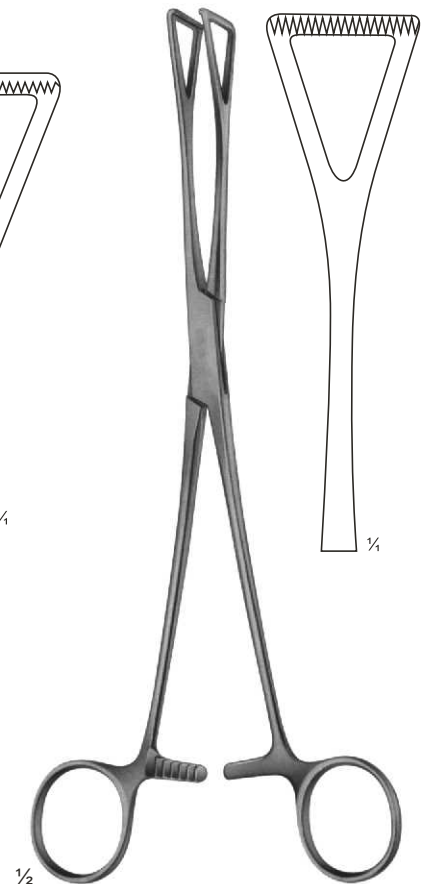

09-117
DUVAL
230 mm,

Organ - Tissue Grasping, Dissecting & Intestinal Forceps

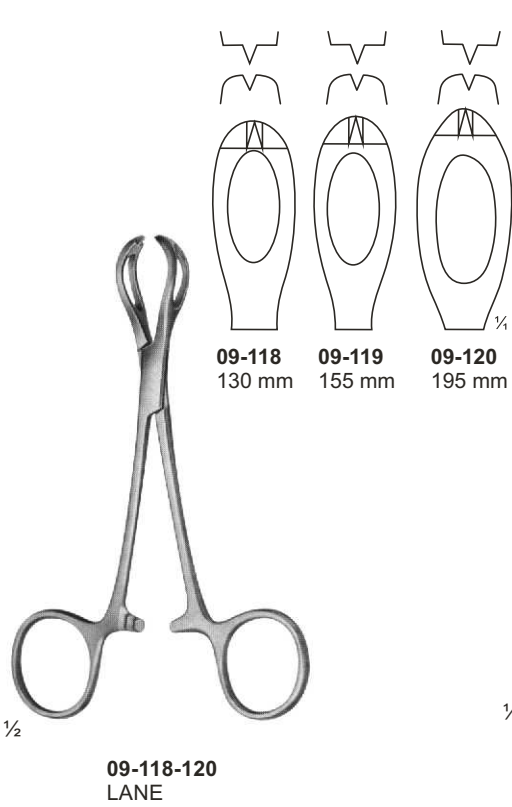

Organ - Tissue Grasping, Dissecting & Intestinal Forceps

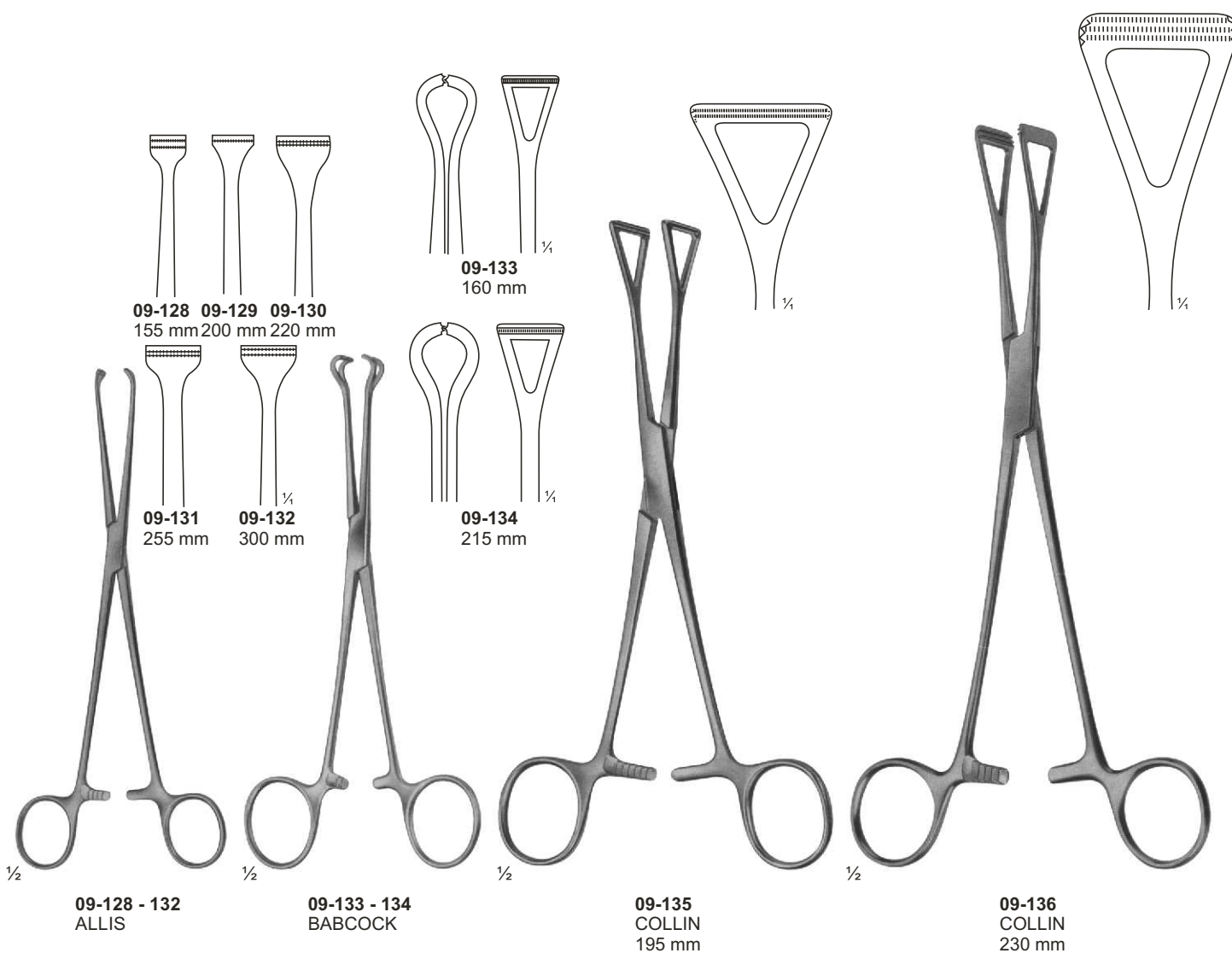

Ultra - Light - Forceps, Dissecting Forceps

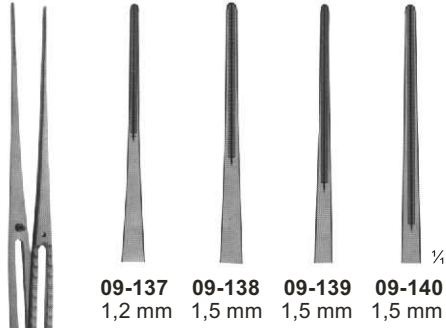

1/2

- 09-137** 150 mm
- 09-138** 200 mm
- 09-139** 240 mm
- 09-140** 300 mm

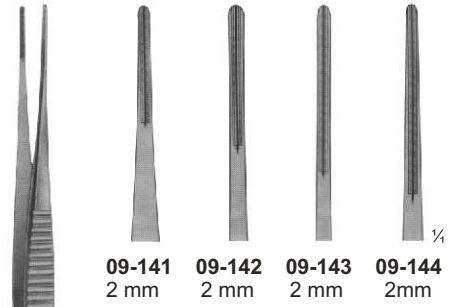

1/2

- DE BAKEY
- 09-141** 150 mm
 - 09-142** 200 mm
 - 09-143** 240 mm
 - 09-144** 300 mm

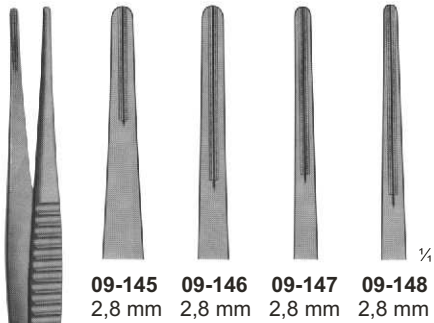

1/2

- DE BAKEY
- 09-145** 150 mm
 - 09-146** 200 mm
 - 09-147** 240 mm
 - 09-148** 300 mm

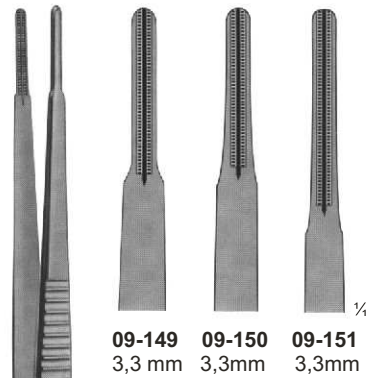

1/2

- DE BAKEY
- 09-149** 200 mm
 - 09-150** 240 mm
 - 09-151** 300 mm

Intestinal Clamps for Children

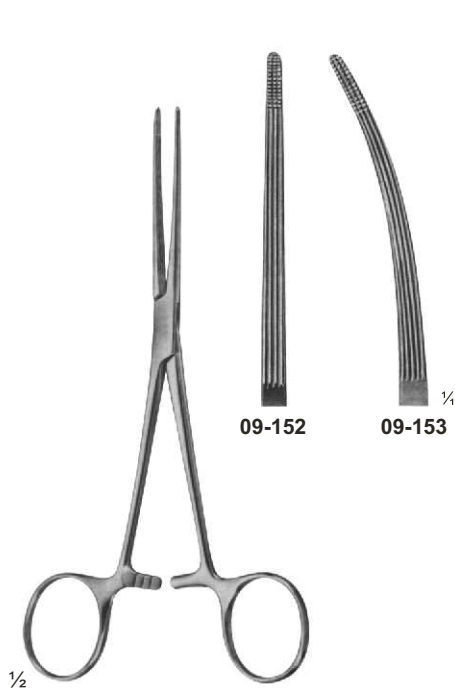

09-152 - 153
BAINBRIDGE
155 mm

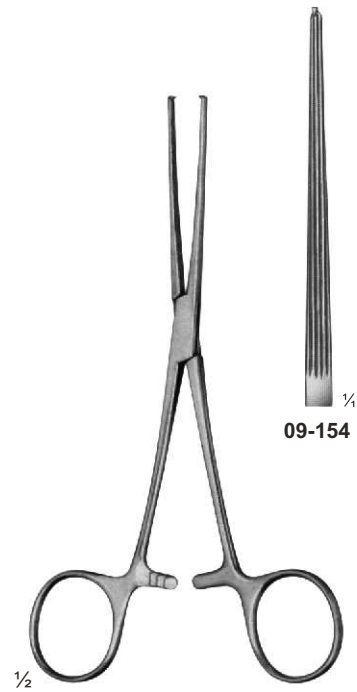

09-154
ALLEN
155 mm

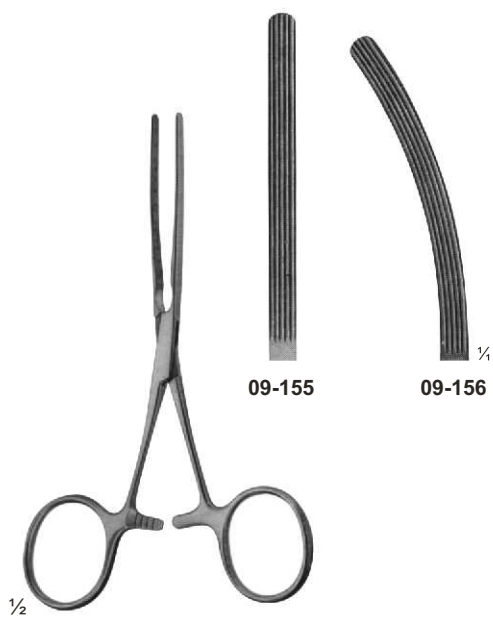

09-155 - 156
BABY-KOCHER
very elastic blades
130 mm

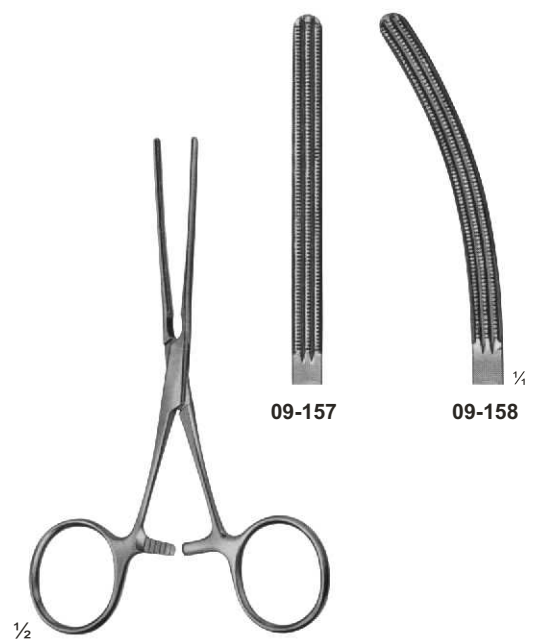

09-157 - 158
BABY-KOCHER
with elastic blades
130 mm

Intestinal Clamps, Soft Elastic

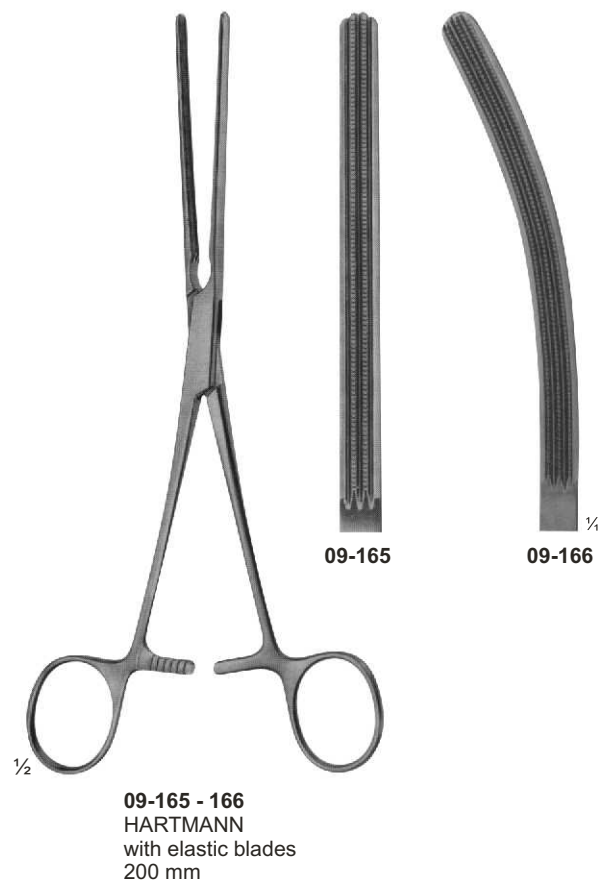
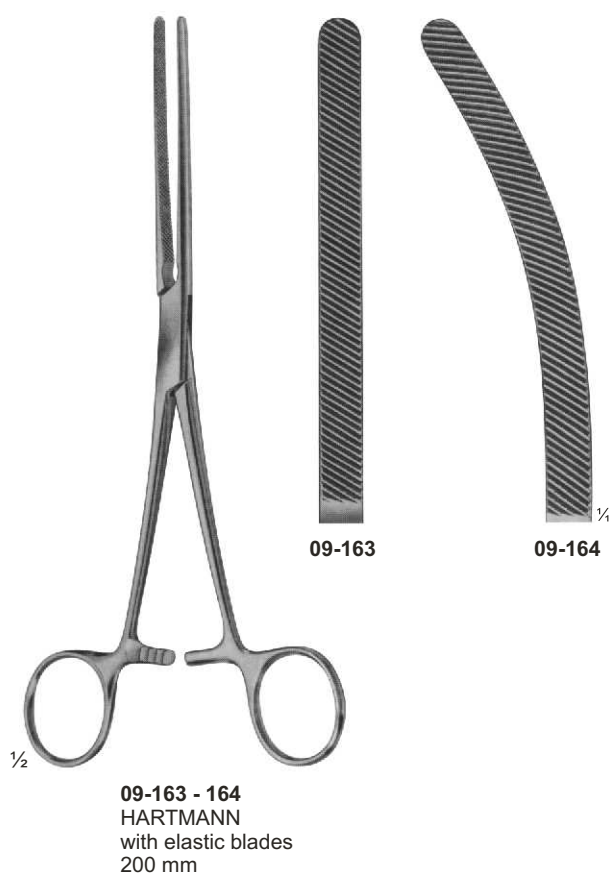
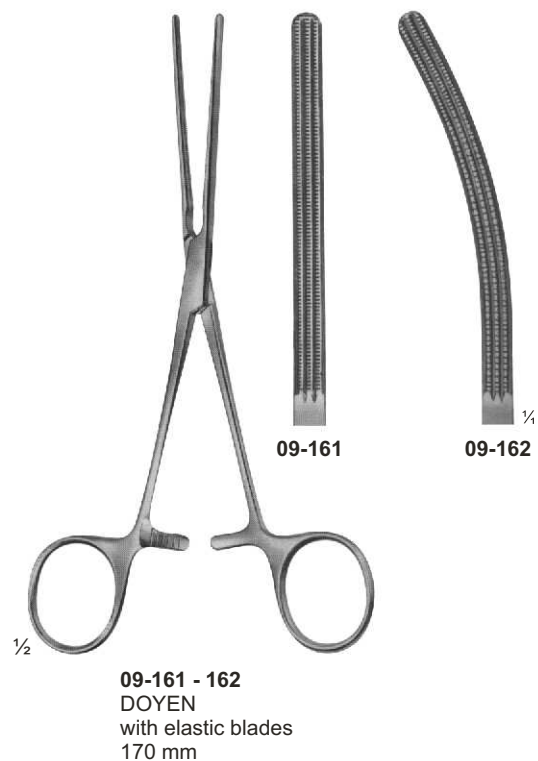
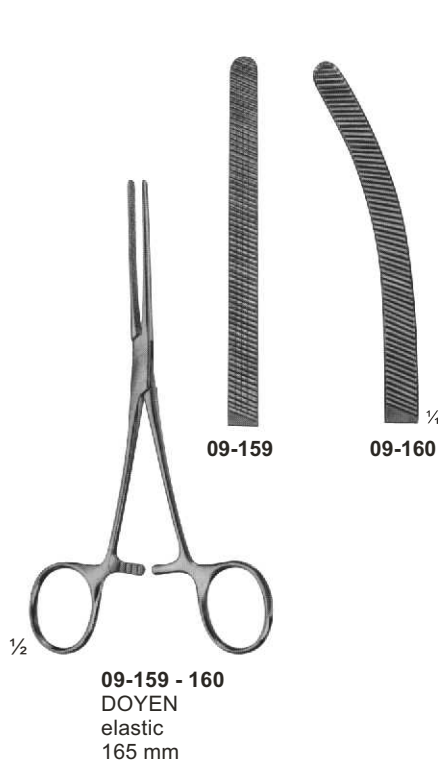

Intestinal Clamps, Soft elastic

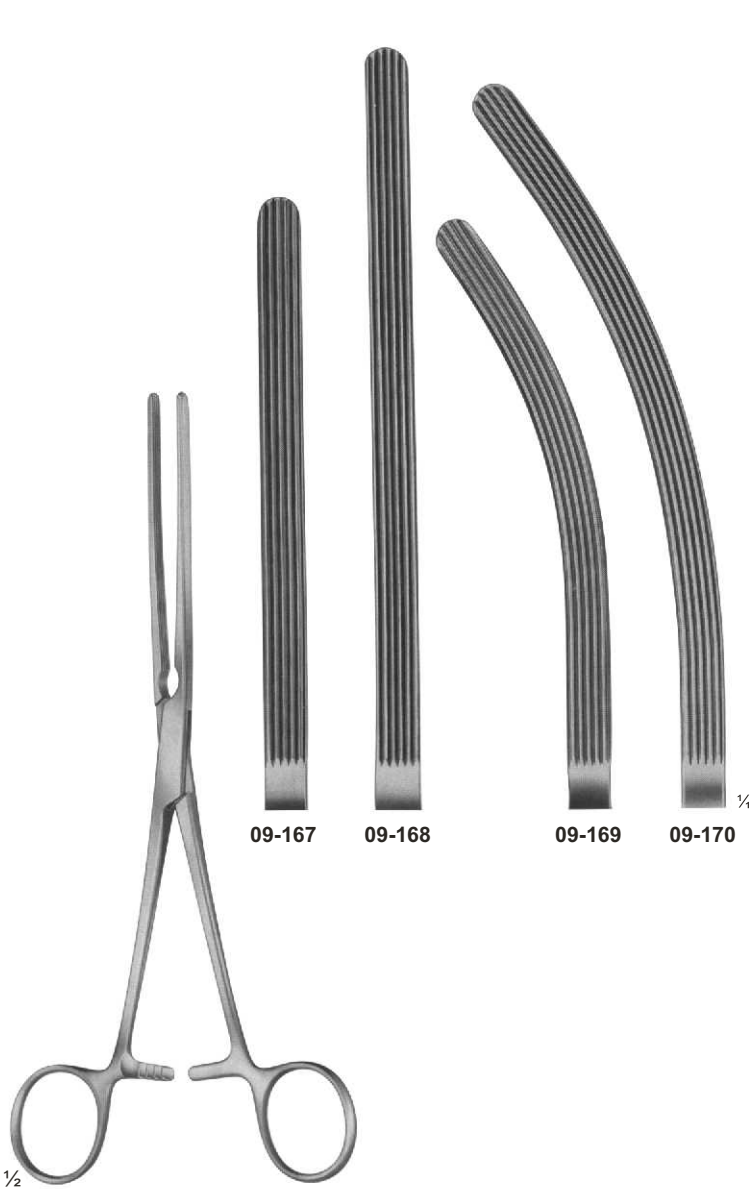

09-167 - 170
KOCHER
 with elastic blades
09-169 210 mm
09-170 230 mm

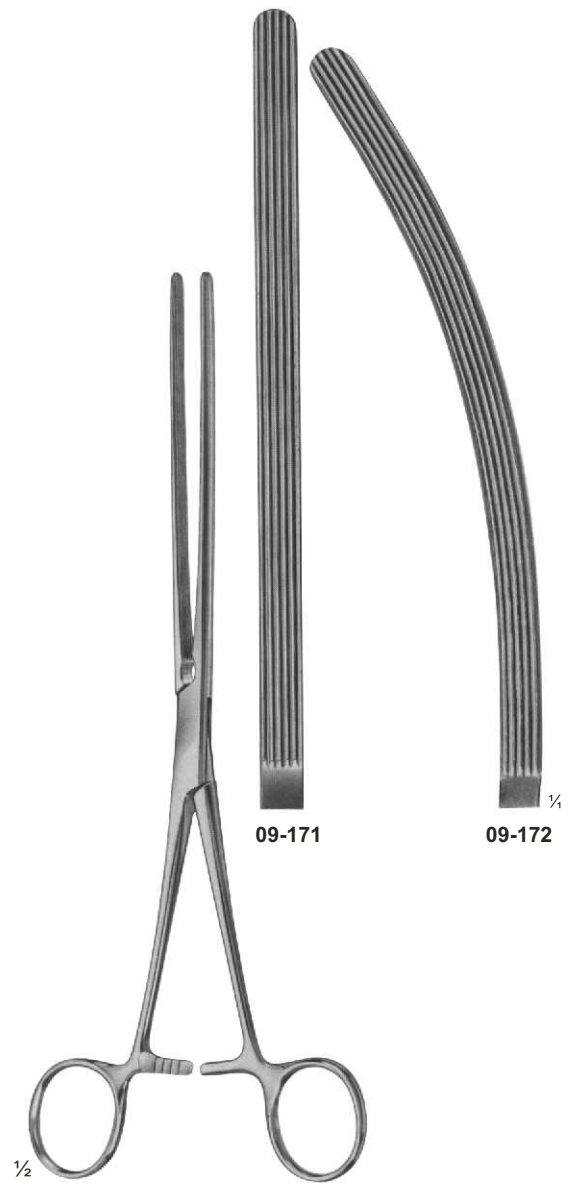

09-171 - 172
DOYEN
 with elastic blades
 210 mm

Intestinal Clamps, Soft elastic

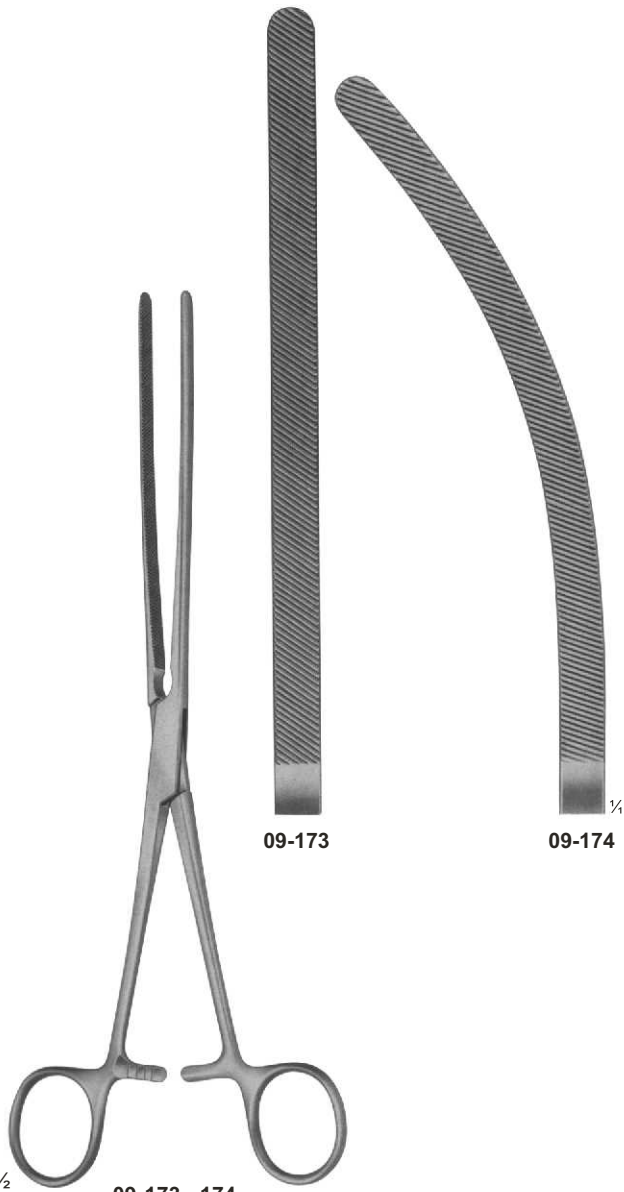

09-173 - 174
DOYEN
with elastic blades
235 mm

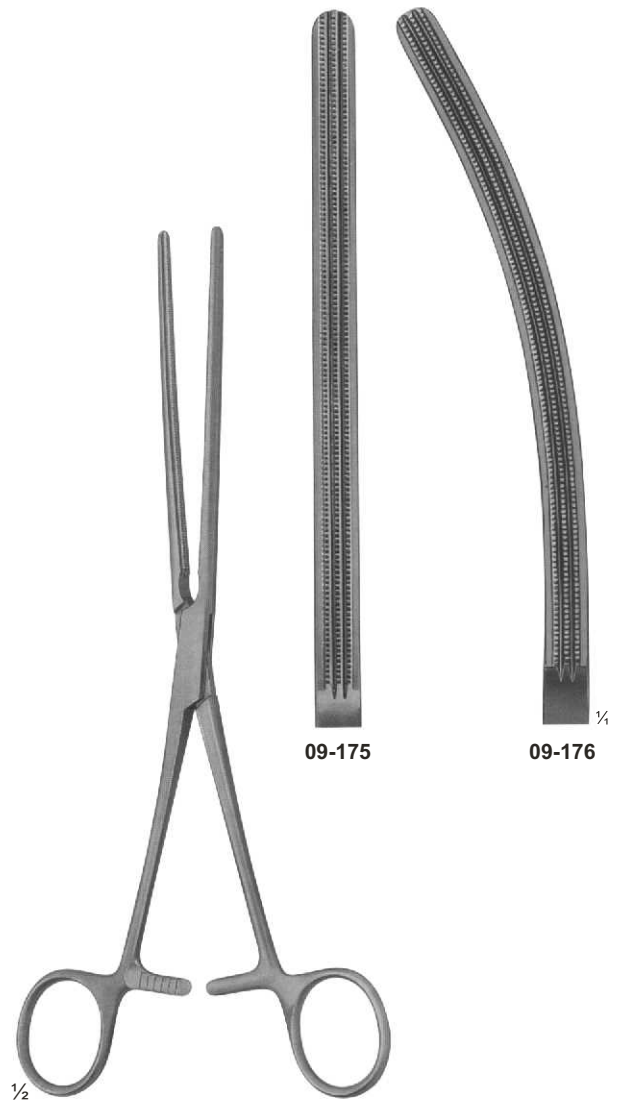

09-175 - 176
DOYEN
with elastic blades
230 mm

Intestinal Clamps, Soft elastic

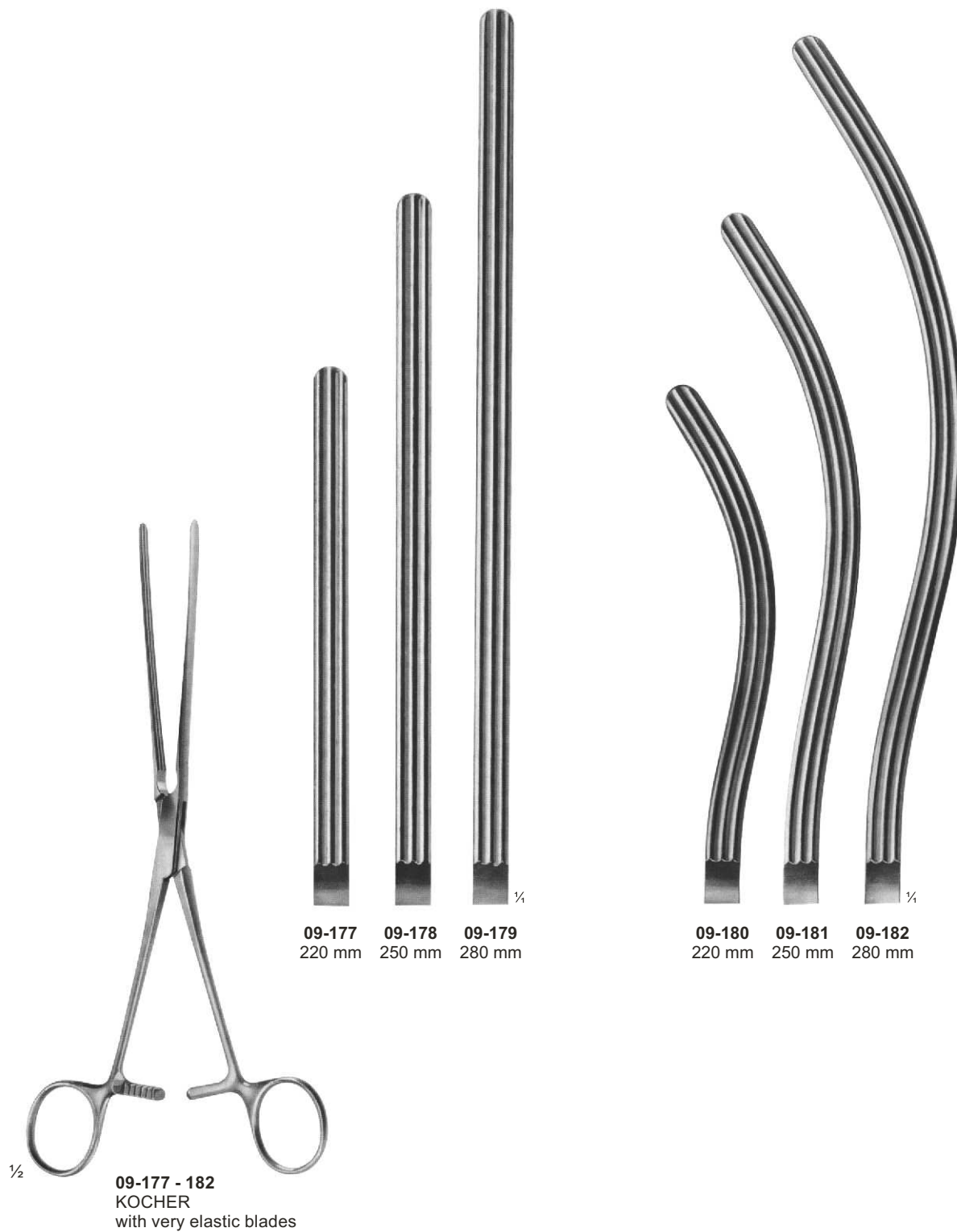

Intestinal Clamps, Soft elastic



09-183 - 188
KOCHER
with very elastic blades



09-183
220 mm



09-184
250 mm



09-185
280 mm

1/4



09-186
220 mm



09-187
250 mm



09-188
280 mm

1/4

Intestinal Clamps

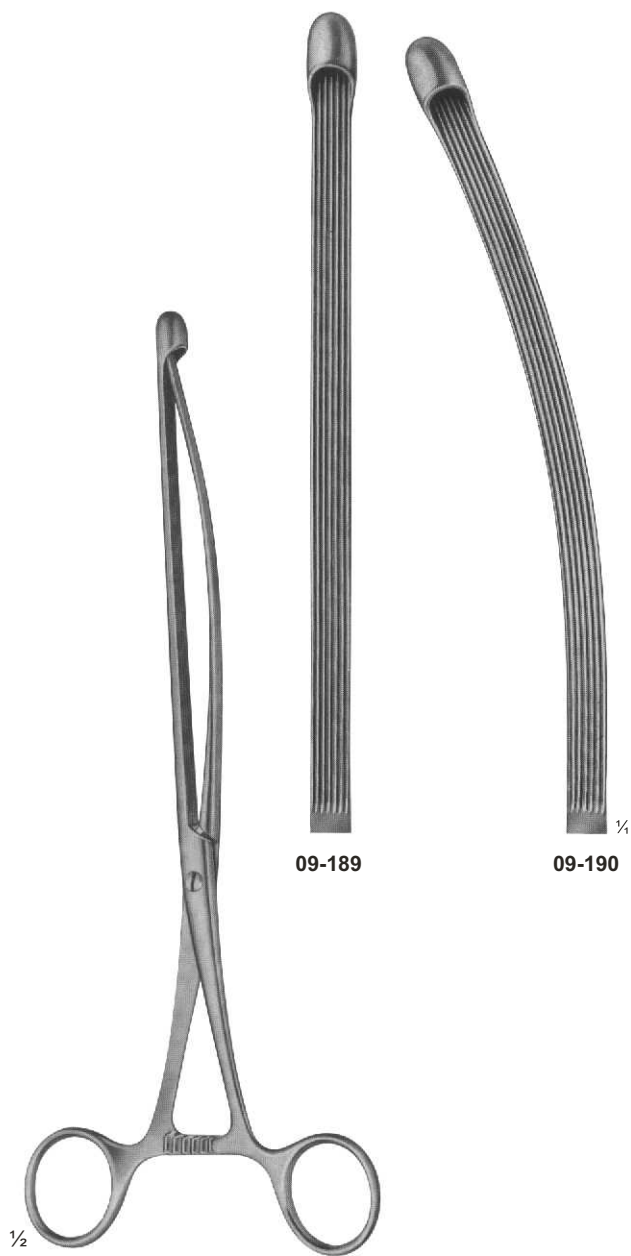

09-189 - 190
NUSSBAUM
with elastic blades
250 mm

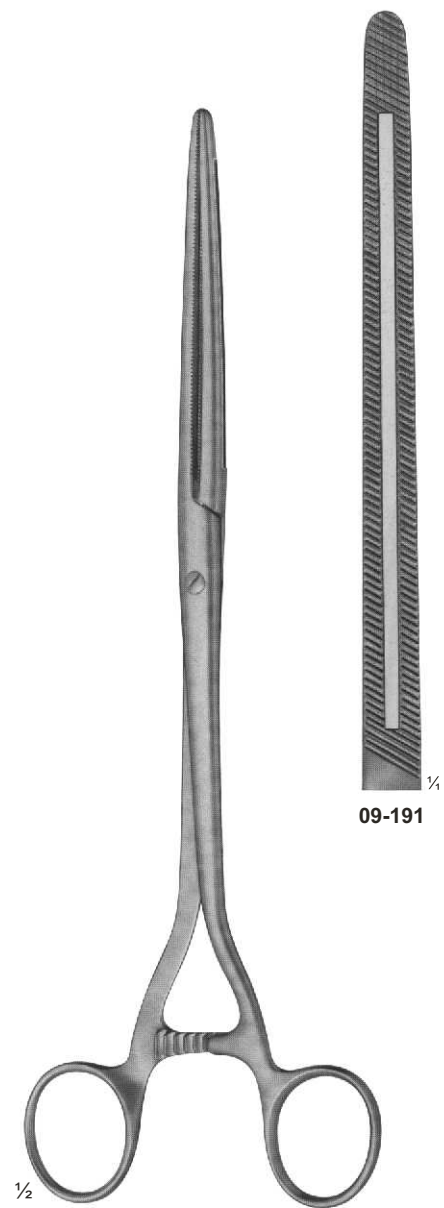

09-191
MOYNIHAN
280 mm

Intestinal Clamps

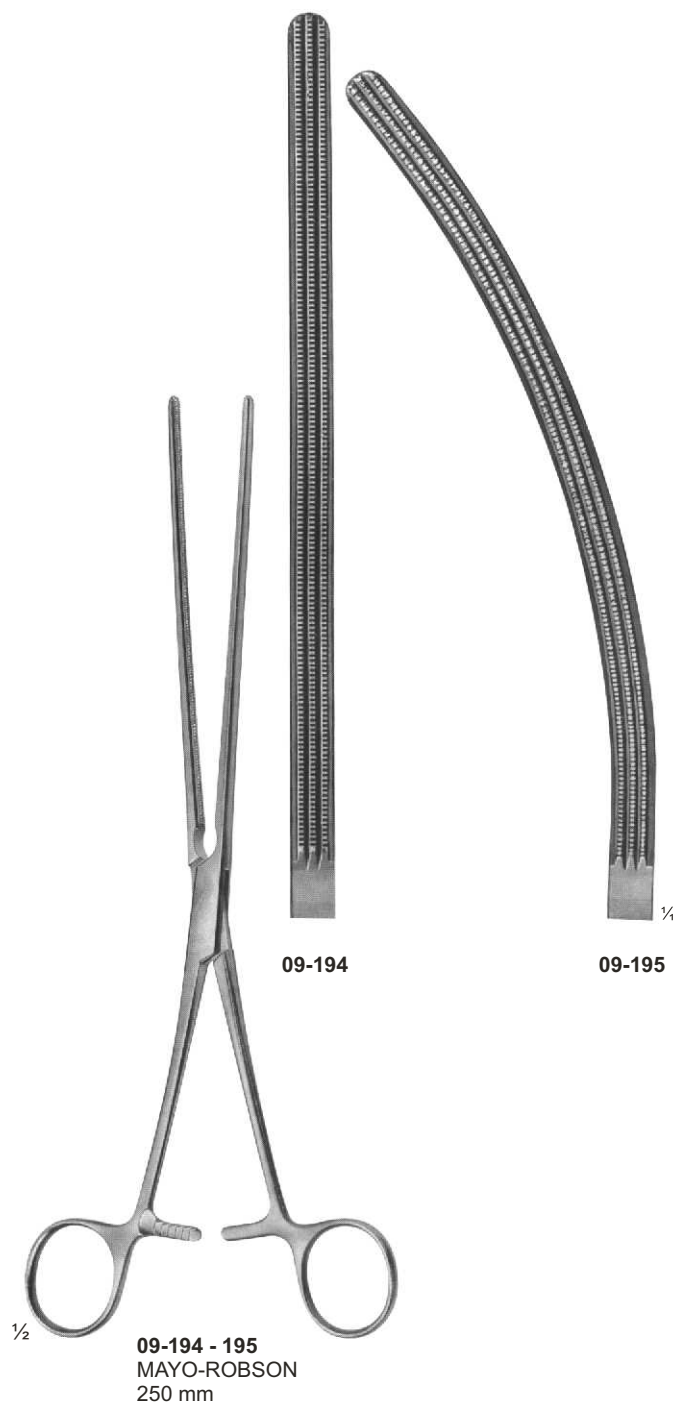
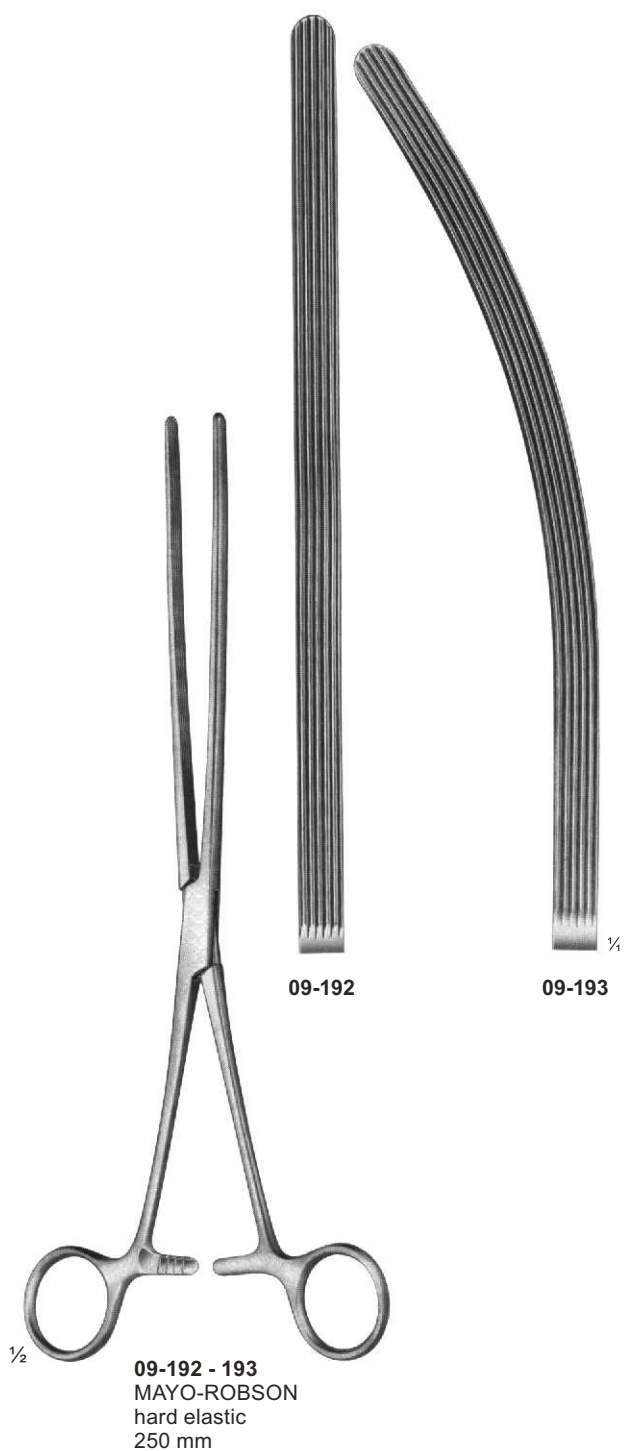

Gastro-Intestinal Forceps, twin



09-196
LANE
300 mm

09-197
LANE
300 mm

Stomach Clamps

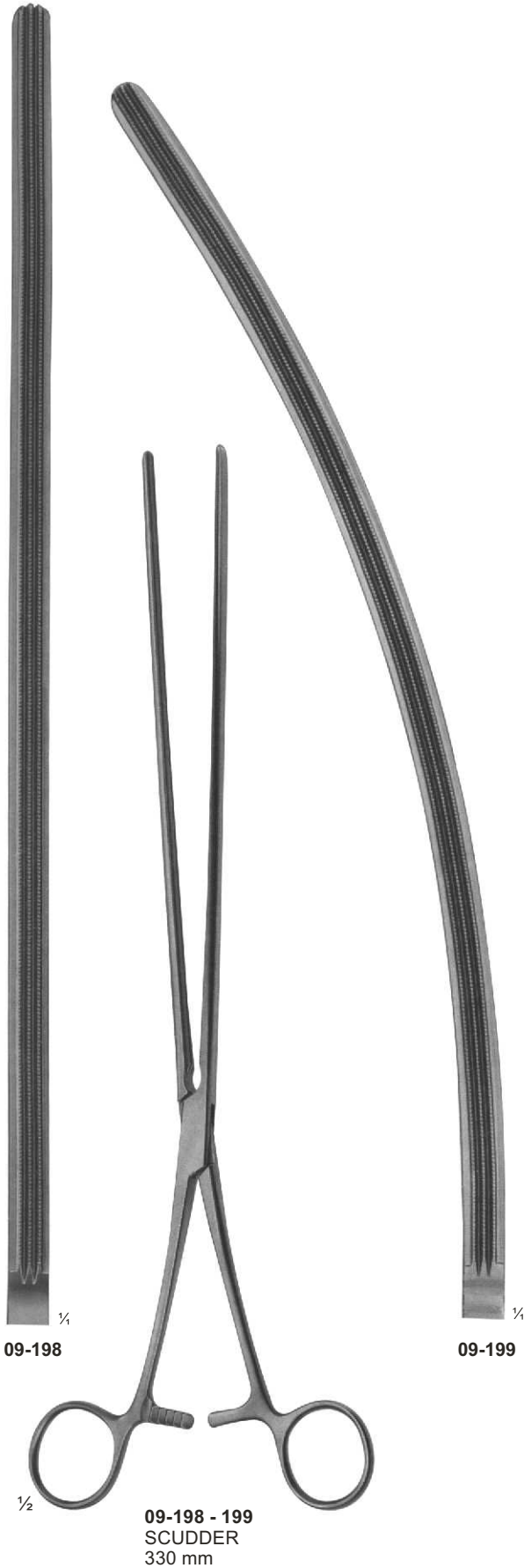

Intestinal and Pylorus Clamps



09-201
PAYR
Intestinal clamp
light pattern,
for children
180 mm

09-202
PAYR
200 mm

09-203
PAYR
275 mm

09-204
PAYR
Pylorus clamp
315 mm

Anastomosis Forceps



09-205
PARKER-KERR
anastomosis forceps
for colon resection
180 mm

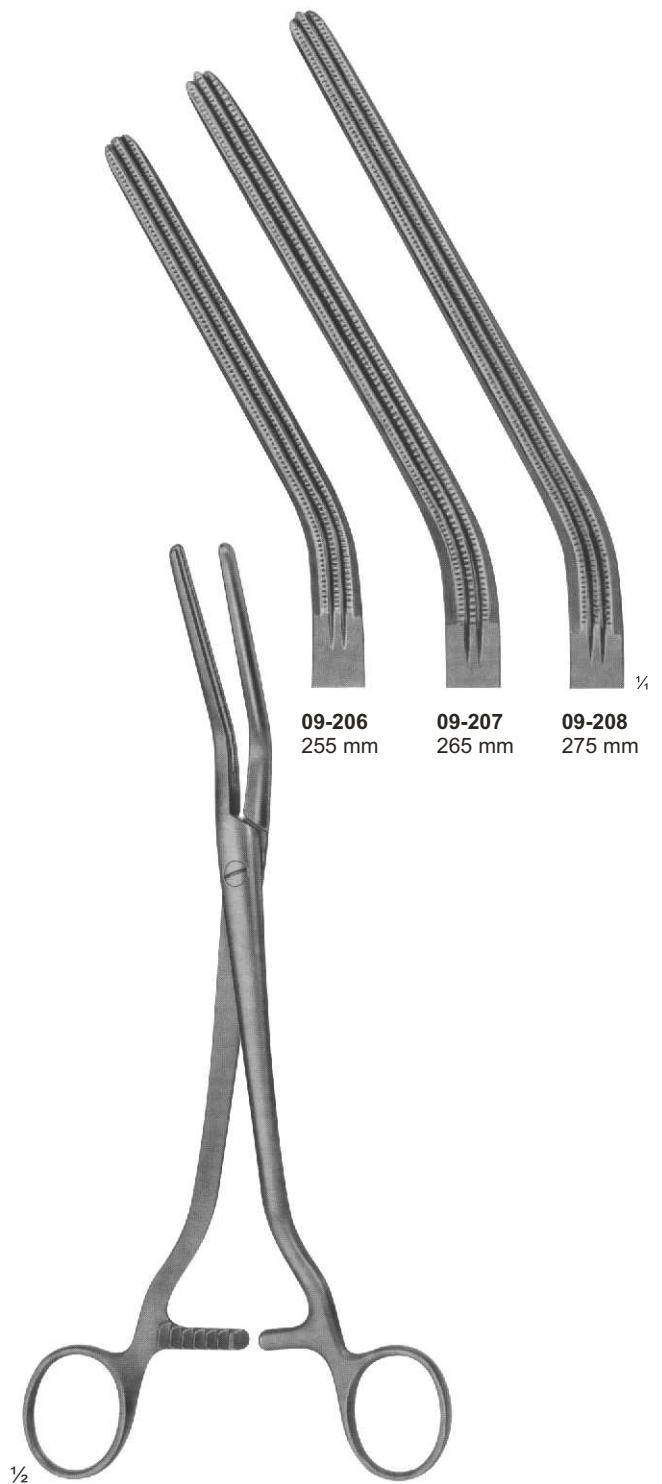

09-206 255 mm
09-207 265 mm
09-208 275 mm

09-206 - 208
DICK
pressure clamps
180 mm

Sigmoid Anastomosis Forceps



Sigmoid Anastomosis Forceps

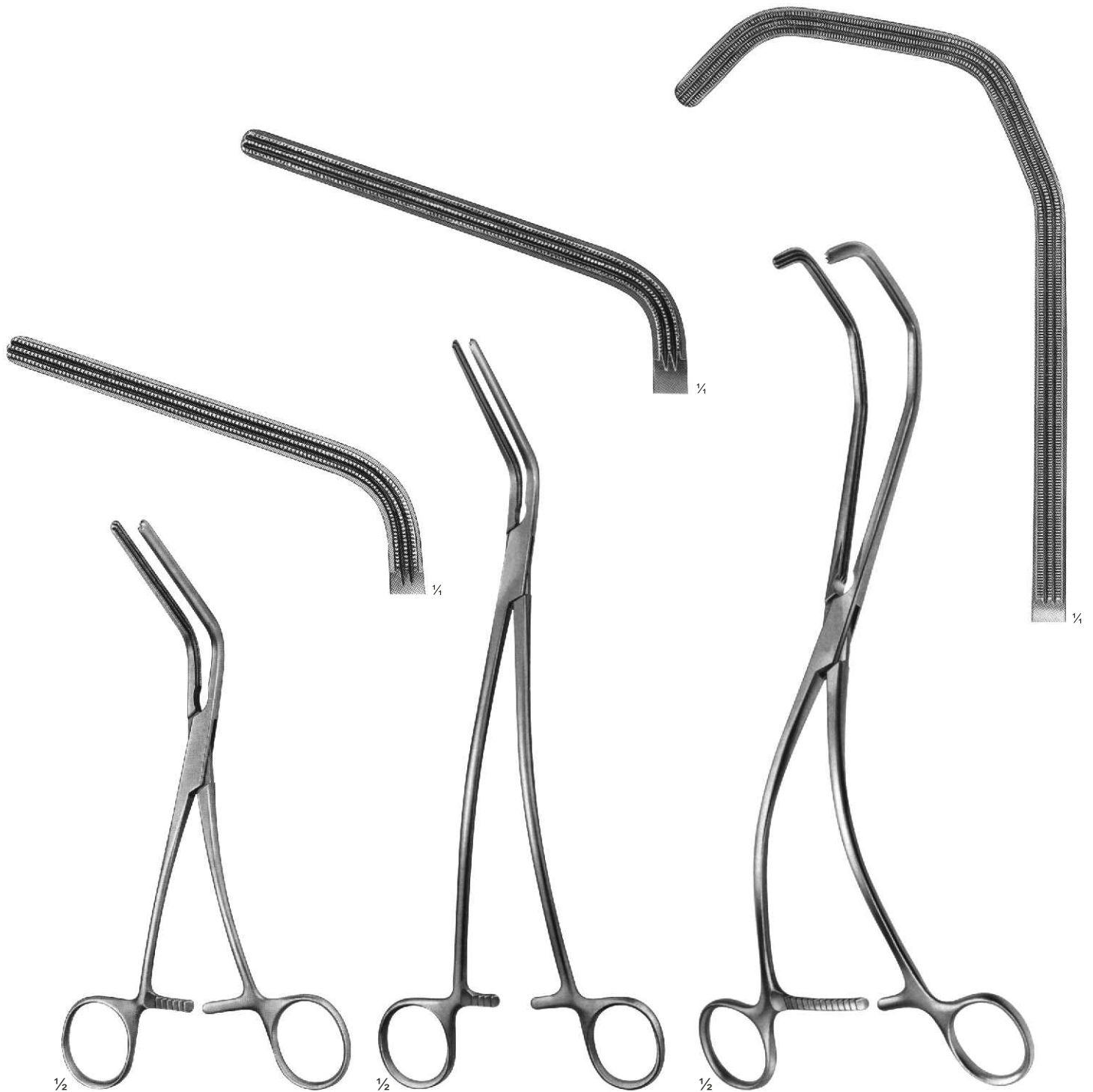

09-212
MORRIS
175 mm

09-213
DE BAKEY
(MORRIS modif.)
240 mm

09-214
KERSTING
270 mm

Rectal Specula

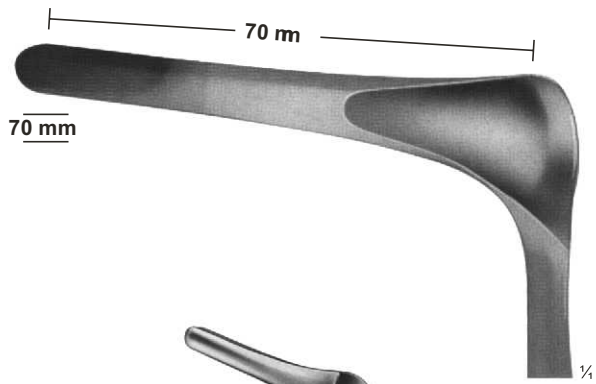

10-101
KILLIAN
for children
145 mm



10-102
SIMS
160 mm



10-103
SIMS
160 mm

Rectal Specula

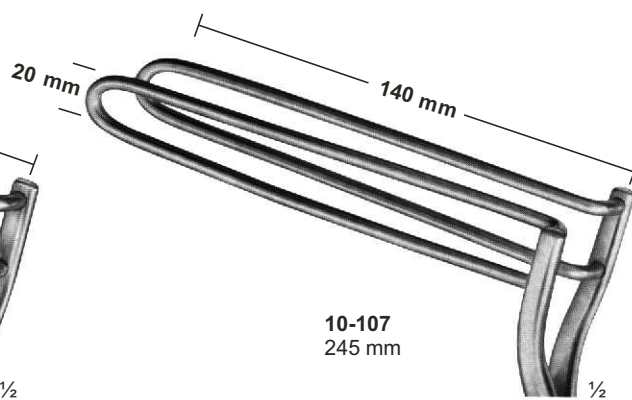
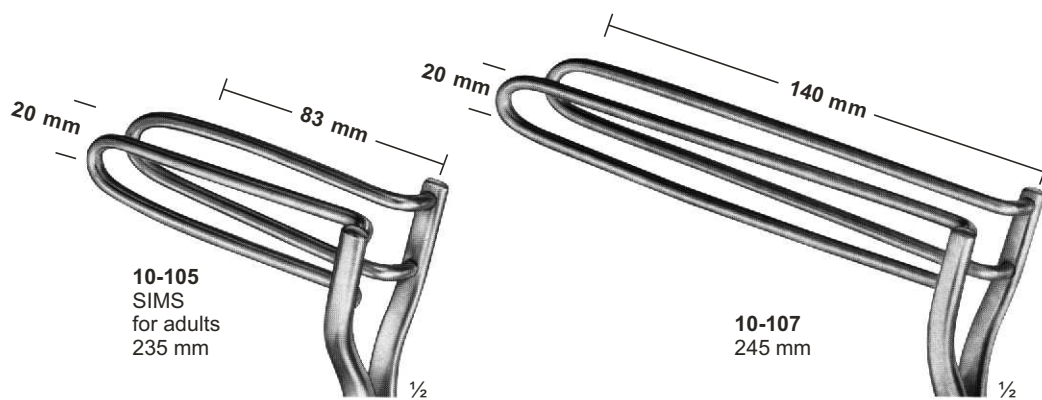
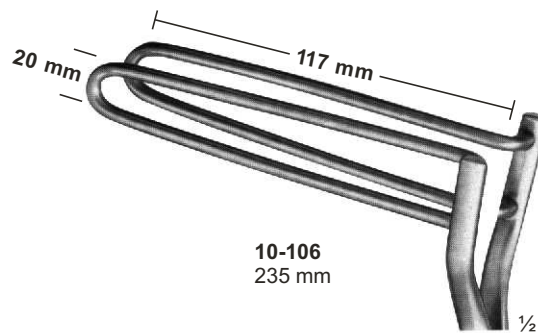
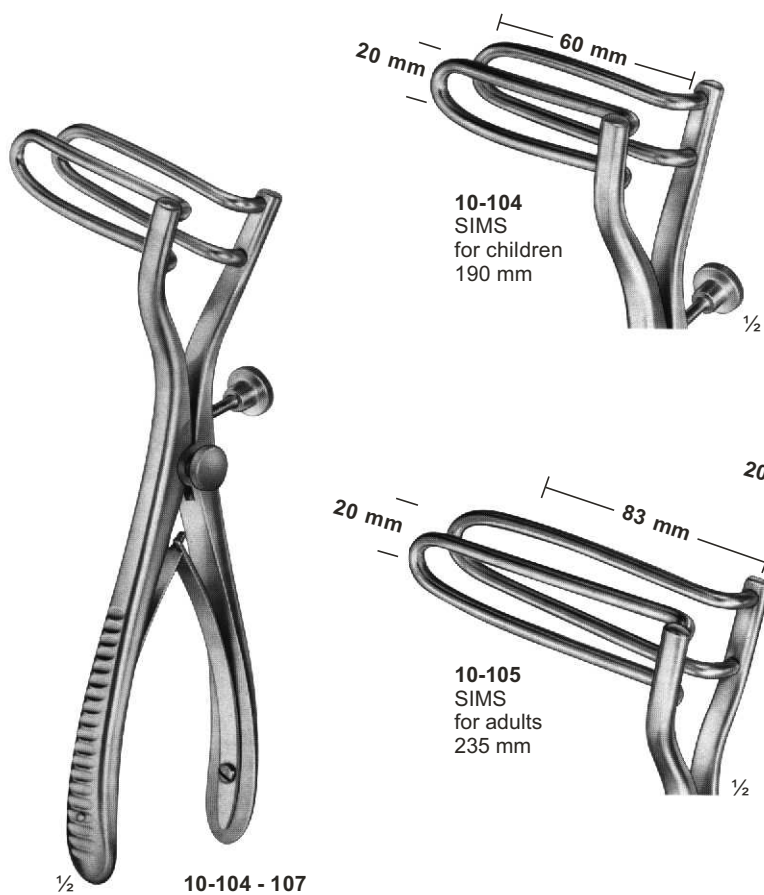

1/2 **10-104 - 107**

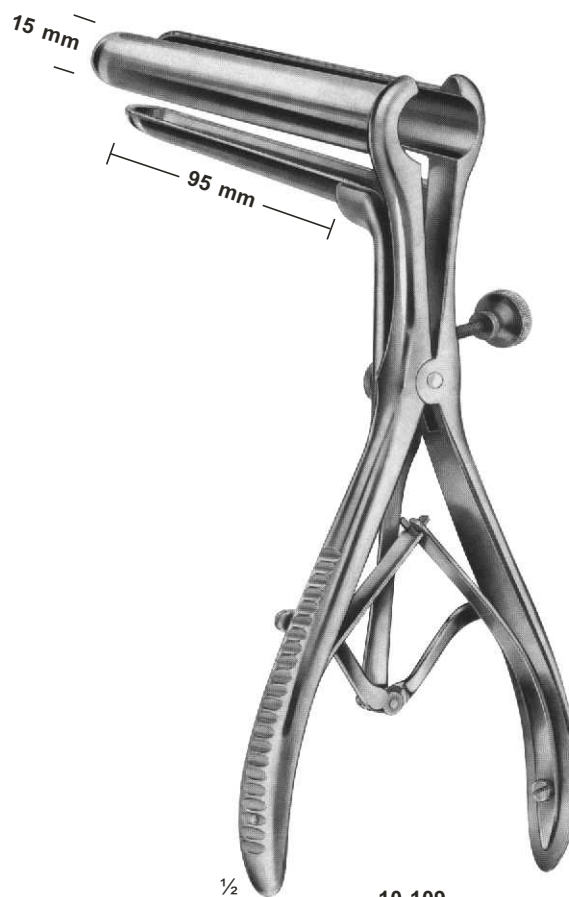

Anusscopes-Sphincteroscopes



10-110
IVES-FANSLER
Anuscope
145 mm



10-111
KELLY
Sphincteroscope
160 mm

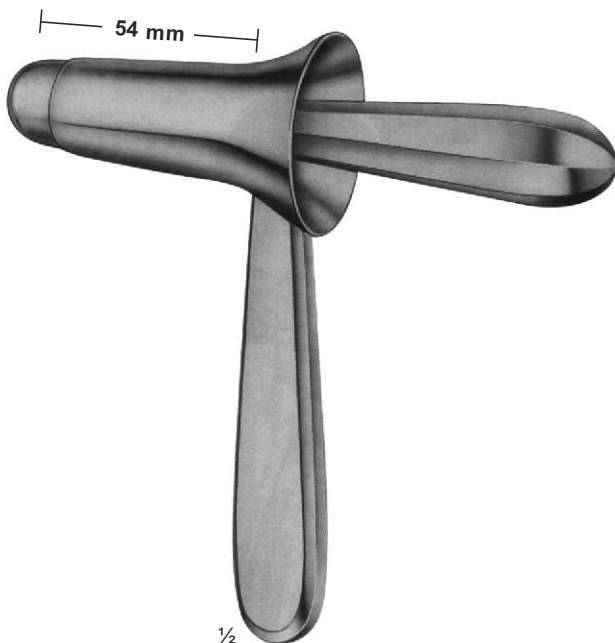

10-112
KELLY
Sphincteroscope
160 mm

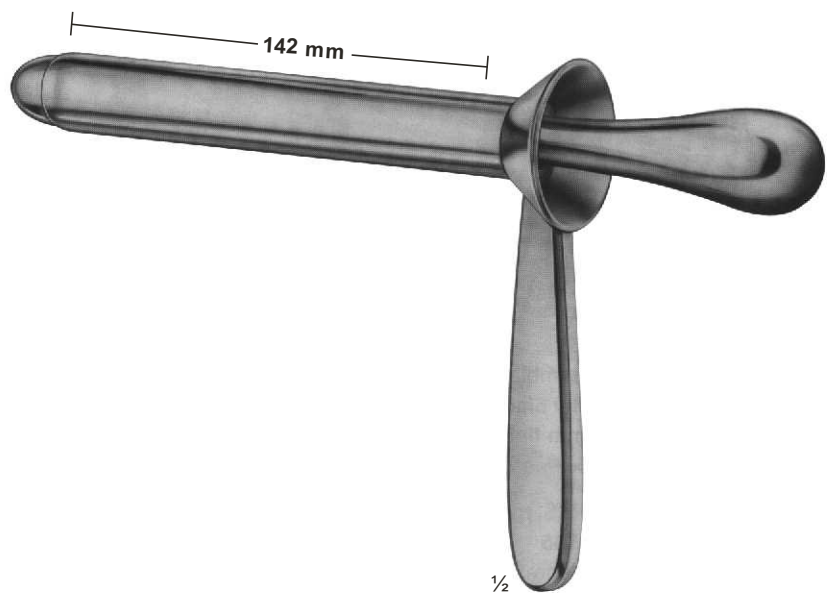

10-113
KELLY
Proctoscope
160 mm

Biopsy forceps for rectum

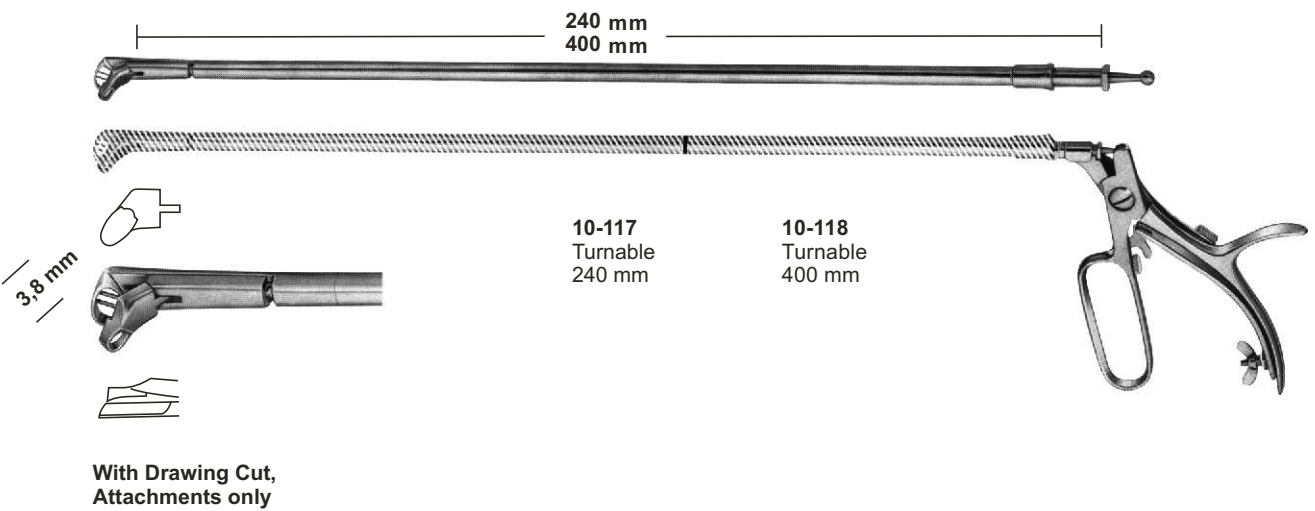
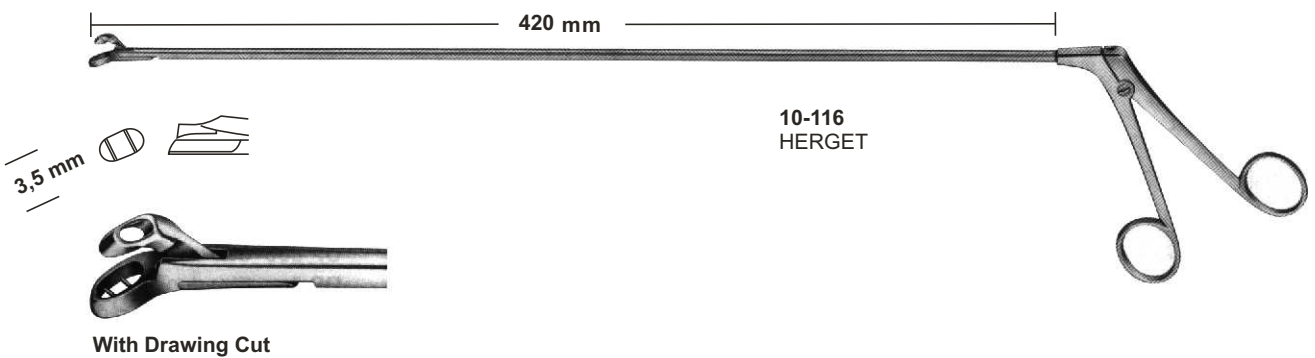
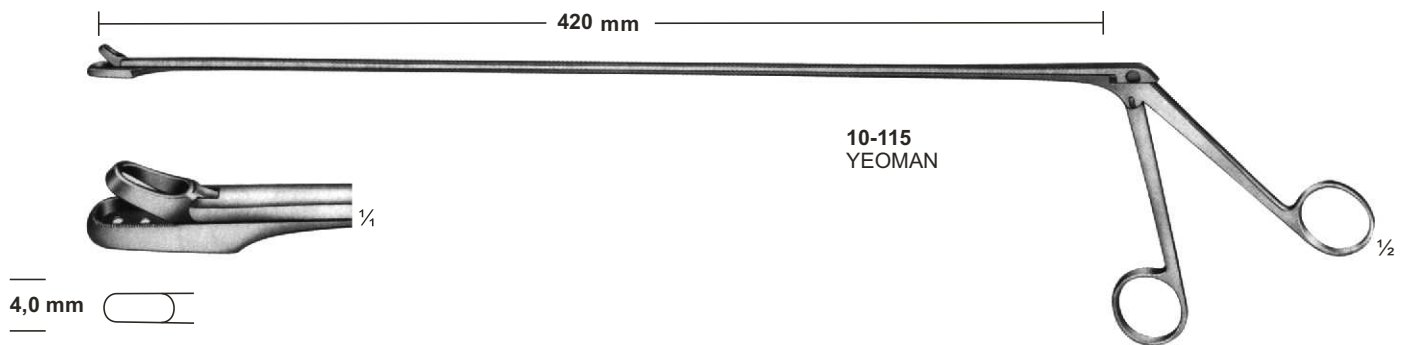
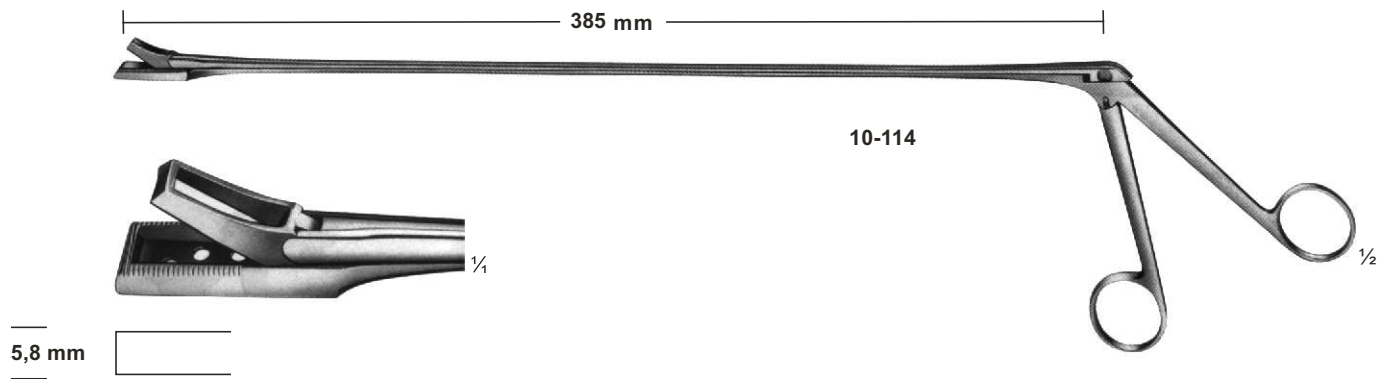

Biopsy Forceps & Swab Holders

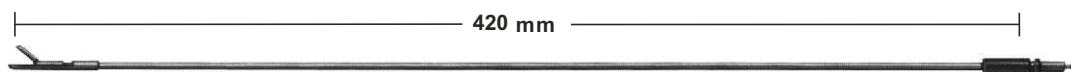

3,5 mm



10-119

3,5 mm

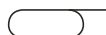

10-120

4,0 mm



10-121

4,0 mm



10-122



10-119 - 122
Handle for 119 - 120 - 121 - 122

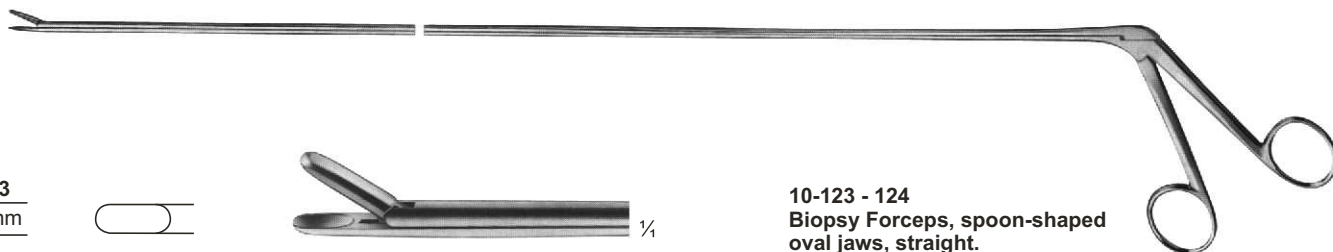

10-123

3,5 mm



10-123 - 124
Biopsy Forceps, spoon-shaped
oval jaws, straight.

10-124

4, mm

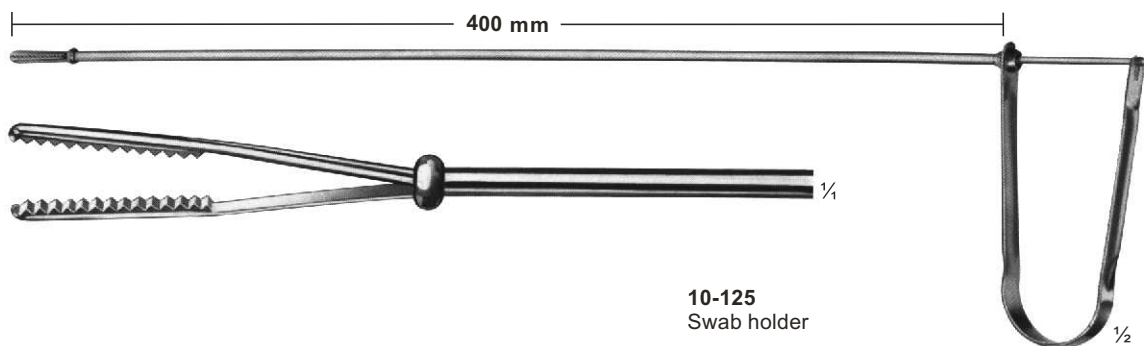

10-125
Swab holder

Haemorrhoidal Forceps

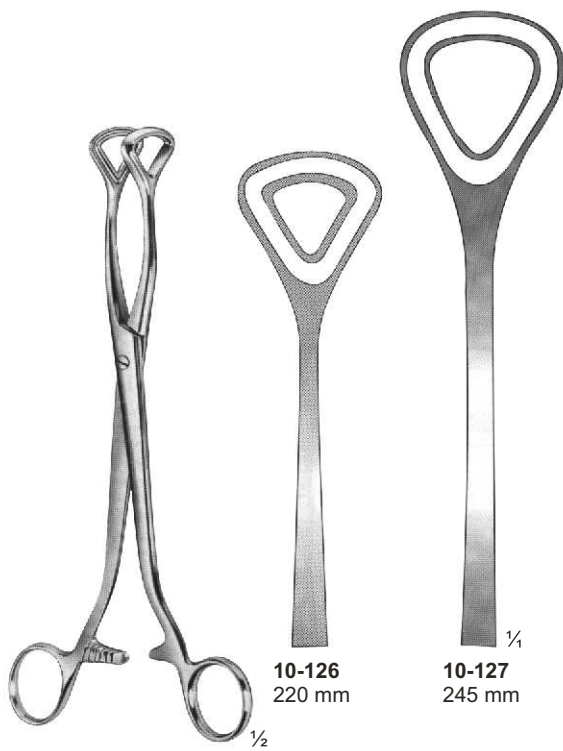

10-126 - 127
LUER

10-126
220 mm

10-127
245 mm

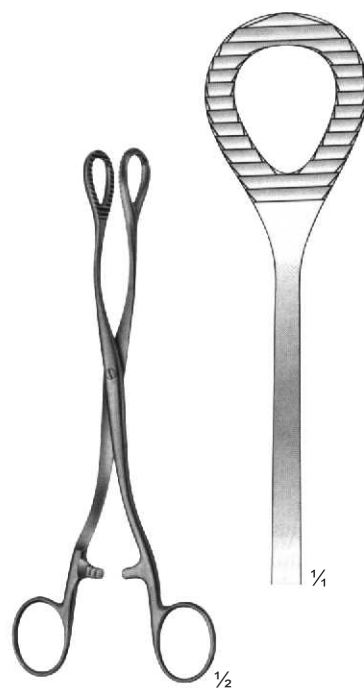

10-128
HEYWOOD-SMITH
200 mm



10-129
HEYWOOD-SMITH
modif
200 mm

Haemorrhoidal Forceps

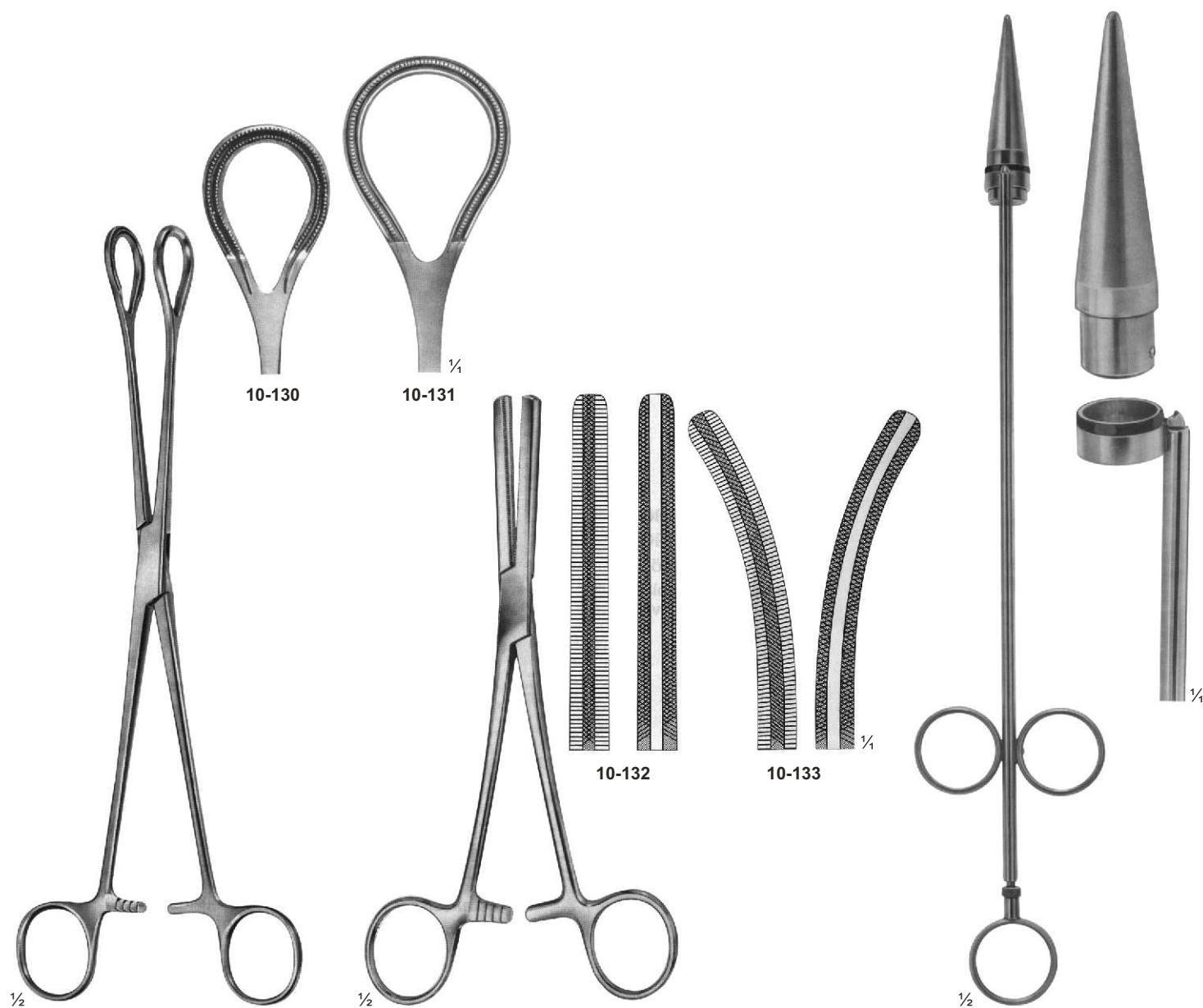

10-130 - 131
250 mm
10-131
270 mm

10-132 - 133
FERGUSSON
200 mm

10-134
RUDD
Haemorrhoidal ligator
with loading
attachment and 100
ligature rubber rings
315 mm

Gall Duct Forceps



10-135
LOWER
180 mm



10-136
LAHEY (SWEET)
190 mm

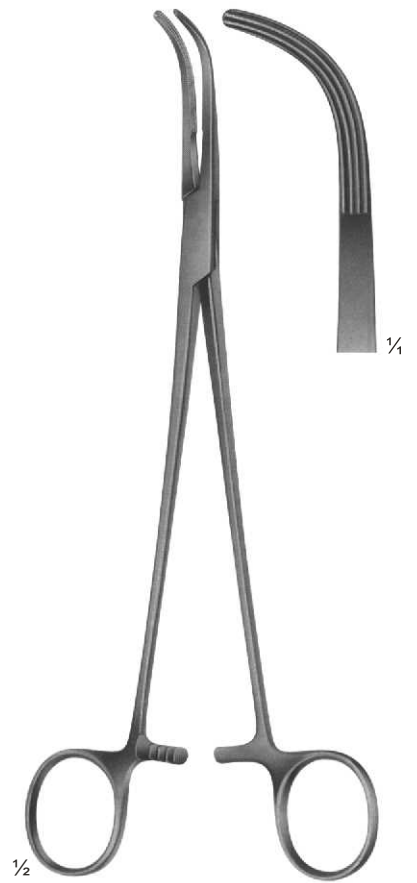

10-137
LAHEY
220 mm



10-138
DESJARDINS
Gall duct-and cystic forceps
210 mm



10-139
NISSEN
Gall duct-and cystic forceps
215 mm

Gall Duct Forceps and Choledochus Forceps

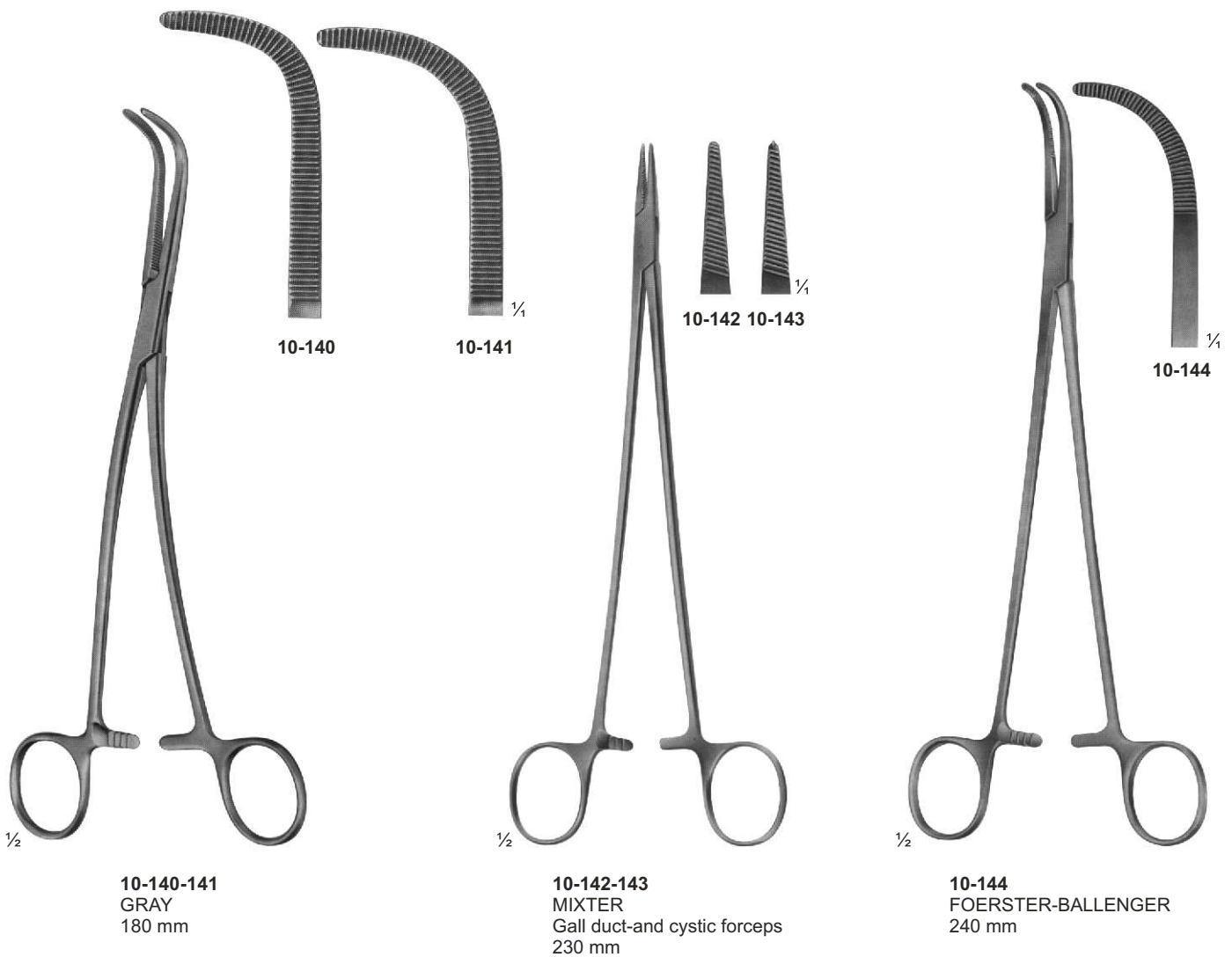

Gall Bladder Forceps and Gall Duct Scissors

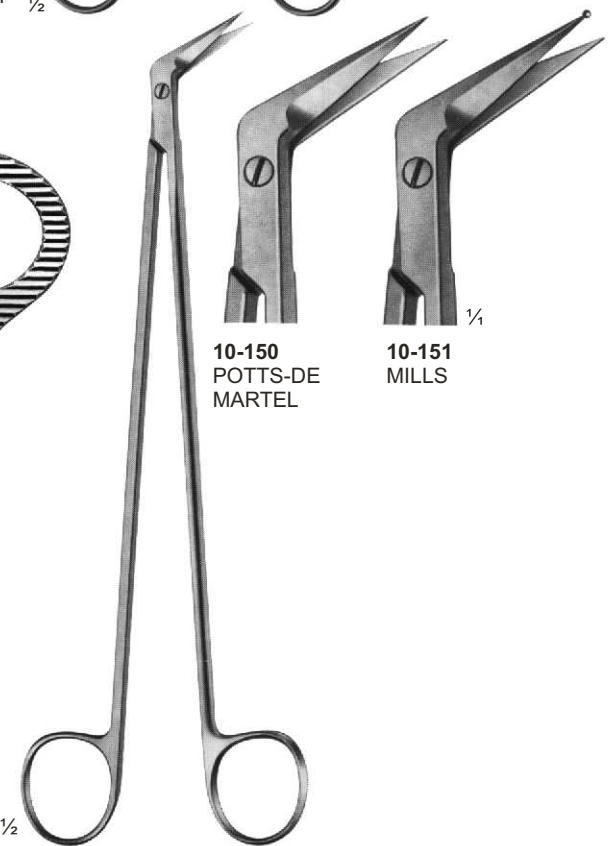
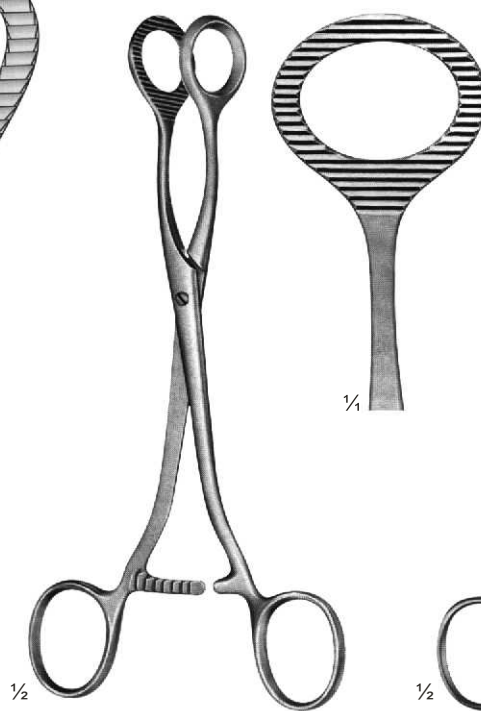
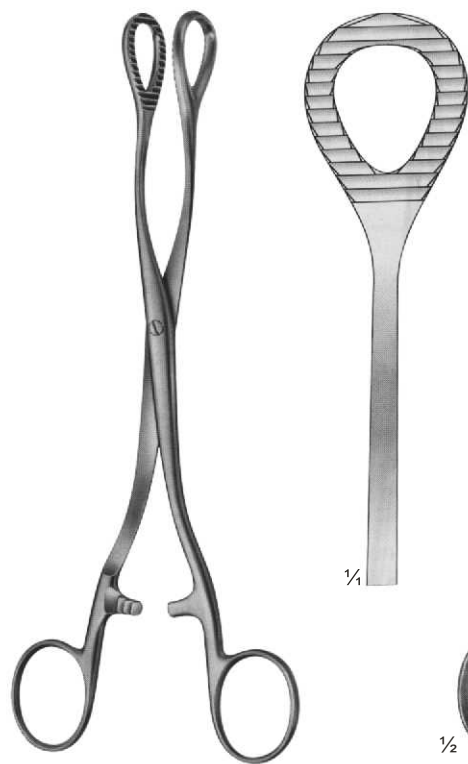
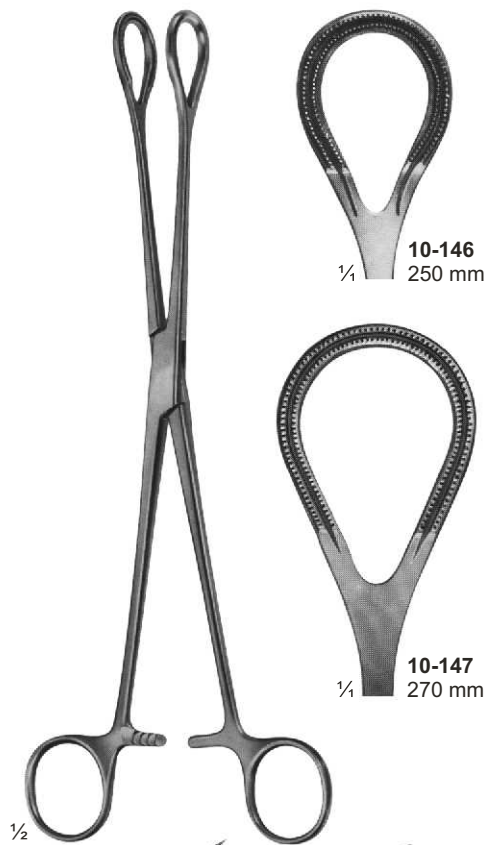
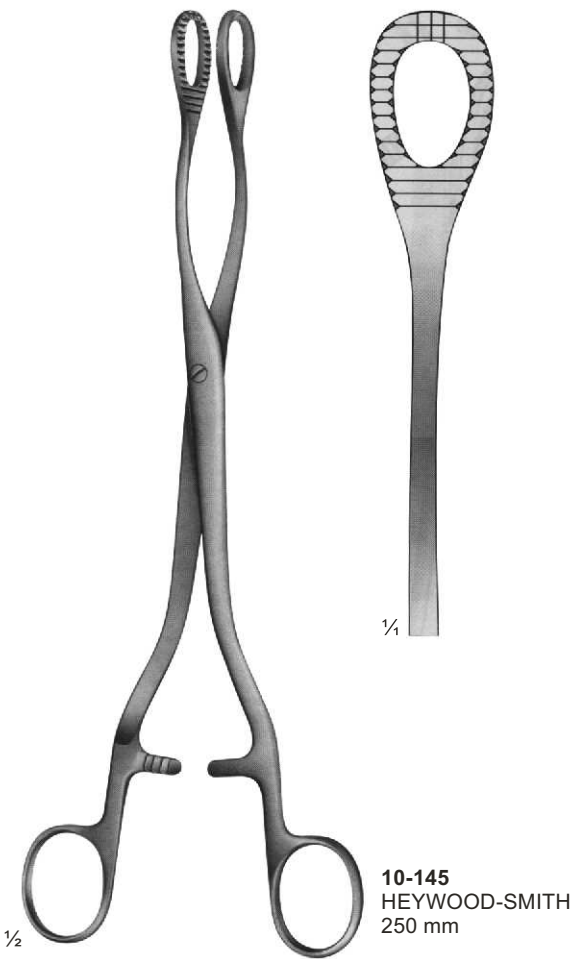

Gall Duct Probes

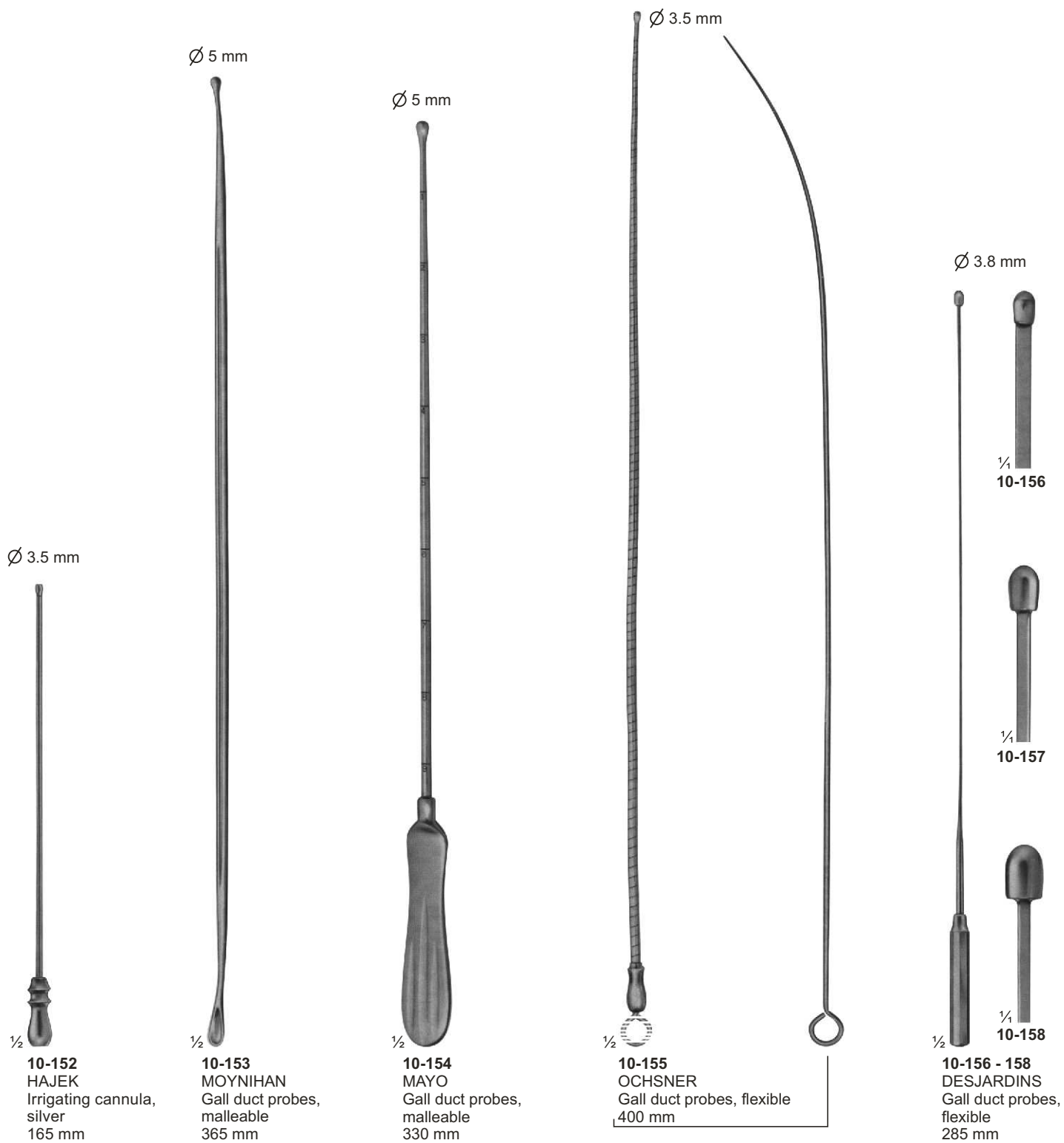

Gall Duct Dilators & Gall Stone Scoops

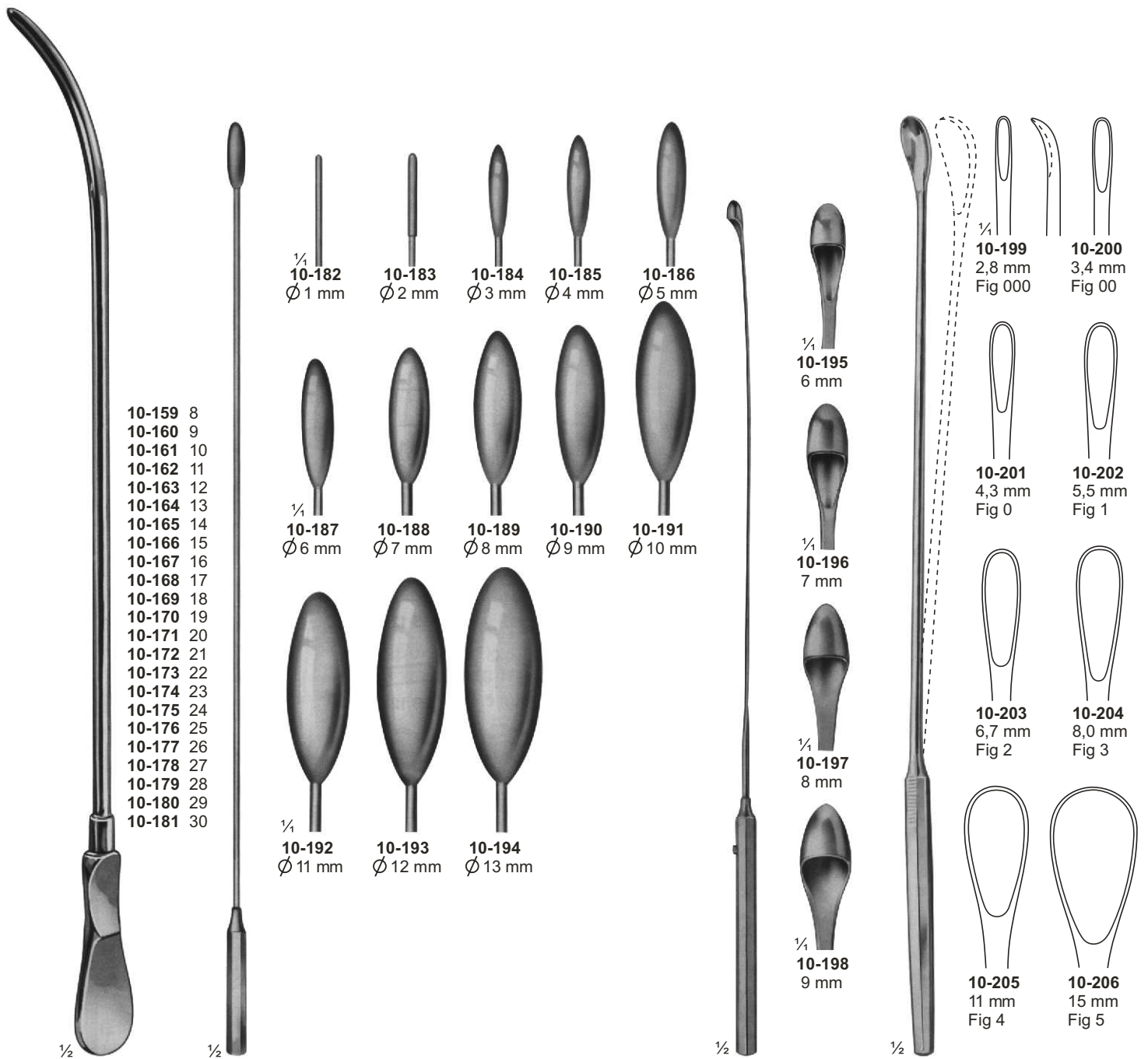

- 10-159 8
- 10-160 9
- 10-161 10
- 10-162 11
- 10-163 12
- 10-164 13
- 10-165 14
- 10-166 15
- 10-167 16
- 10-168 17
- 10-169 18
- 10-170 19
- 10-171 20
- 10-172 21
- 10-173 22
- 10-174 23
- 10-175 24
- 10-176 25
- 10-177 26
- 10-178 27
- 10-179 28
- 10-180 29
- 10-181 30

1/4
10-182
Ø 1 mm

10-183
Ø 2 mm

10-184
Ø 3 mm

10-185
Ø 4 mm

10-186
Ø 5 mm

1/4
10-187
Ø 6 mm

10-188
Ø 7 mm

10-189
Ø 8 mm

10-190
Ø 9 mm

10-191
Ø 10 mm

1/4
10-192
Ø 11 mm

10-193
Ø 12 mm

10-194
Ø 13 mm

1/4
10-195
6 mm

1/4
10-196
7 mm

1/4
10-197
8 mm

1/4
10-198
9 mm

1/4
10-199
2,8 mm
Fig 000

10-200
3,4 mm
Fig 00

10-201
4,3 mm
Fig 0

10-202
5,5 mm
Fig 1

10-203
6,7 mm
Fig 2

10-204
8,0 mm
Fig 3

10-205
11 mm
Fig 4

10-206
15 mm
Fig 5

10-159 - 181
DITTEL
Metall bougies and dilating sounds, stiff 345 mm

10-182 - 194
BAKES
Common bile duct dilators, malleable 315 mm, 320 mm

10-195 - 198
DESJARDINS
Probes and catch with flexible shaft 300 mm

10-199 - 206
LUER-KORTE modif
with malleable shaft 310 mm

Gall Stone Forceps

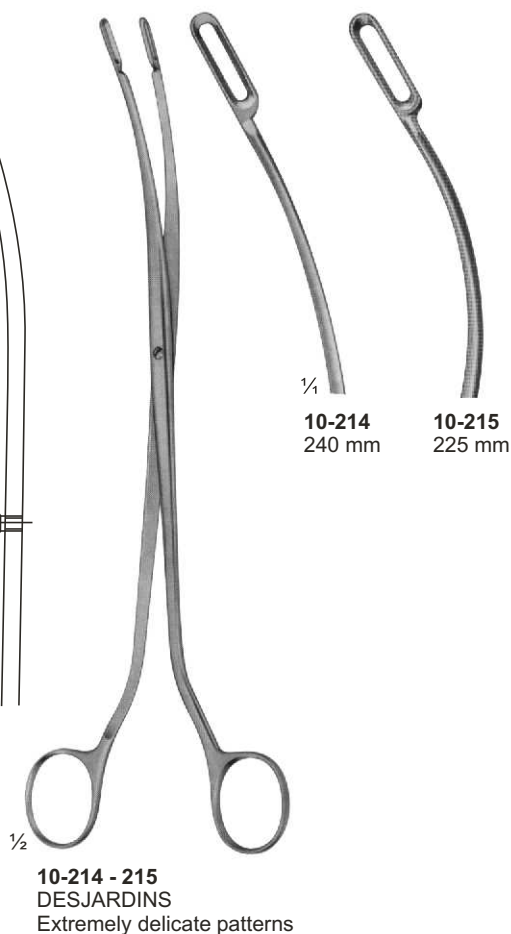
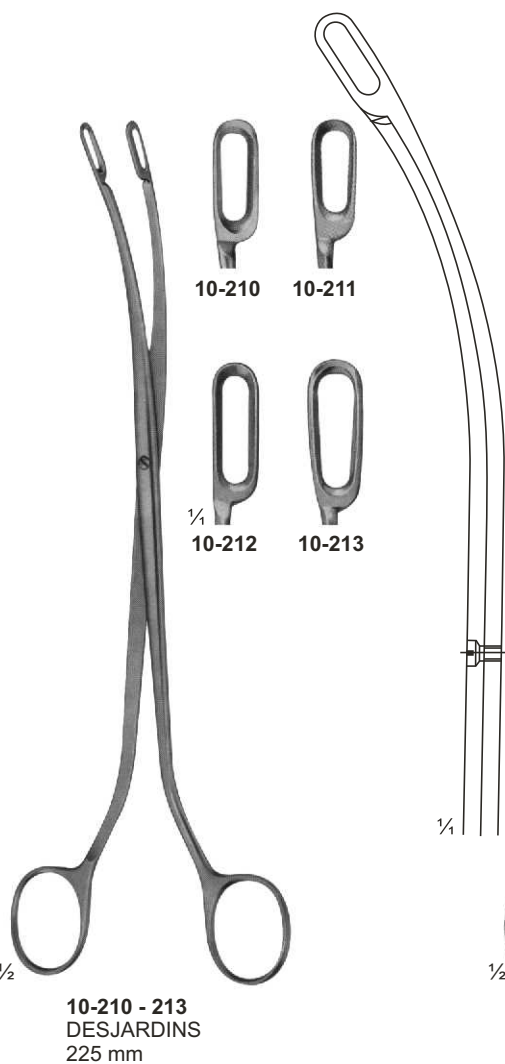
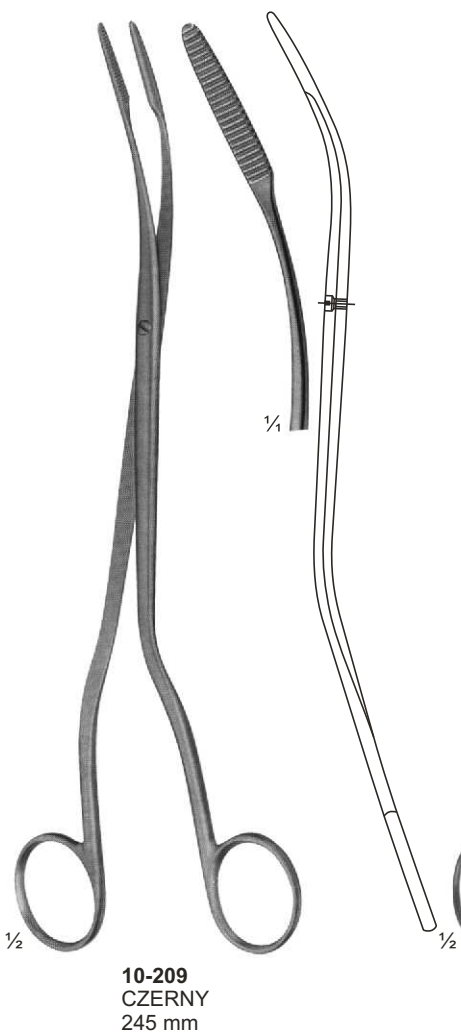
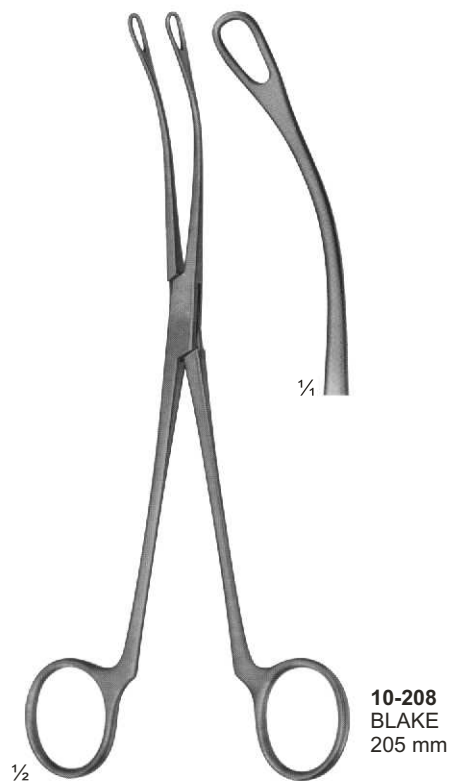
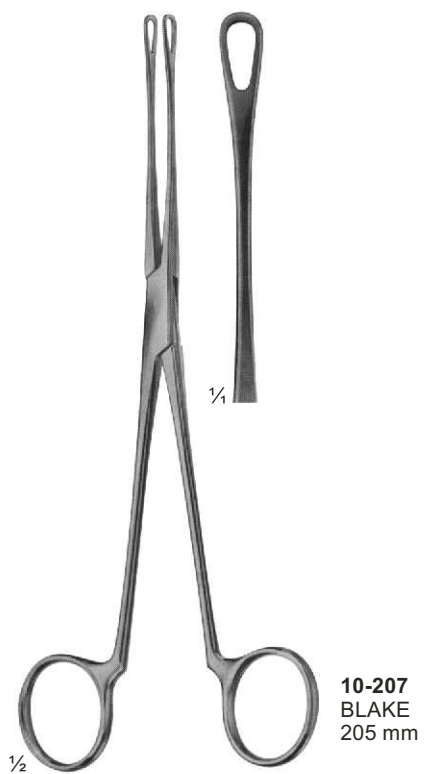

Kidney Clamps

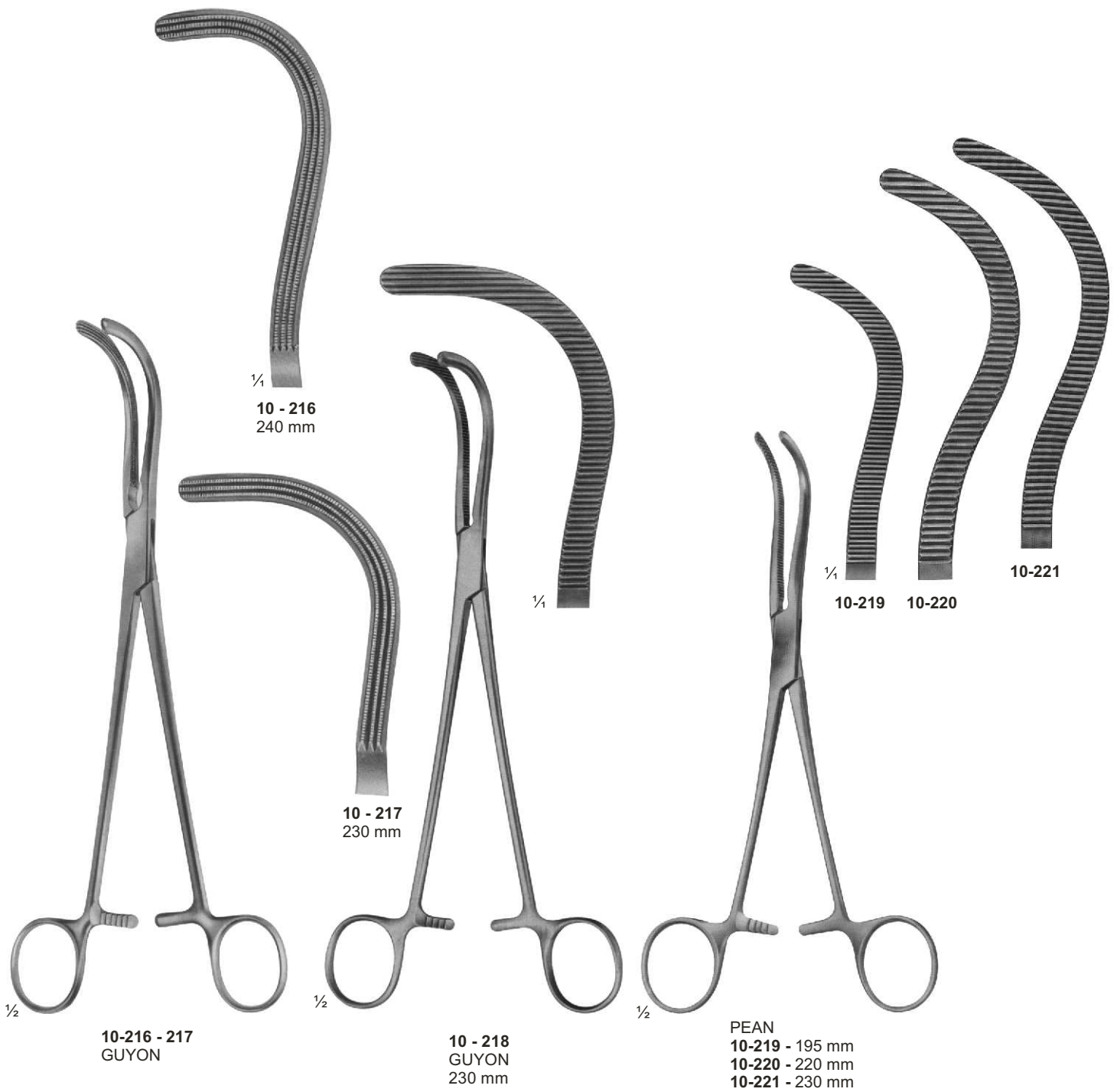

Kidney Clamps

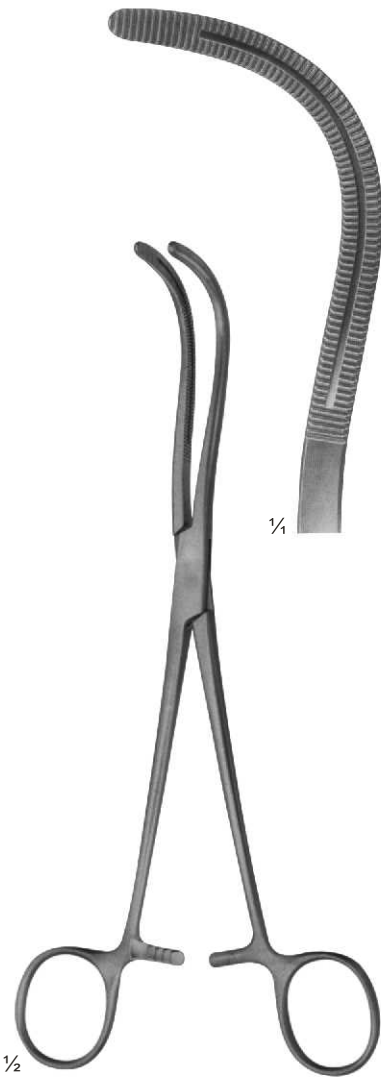

10-222
STILLE
220 mm

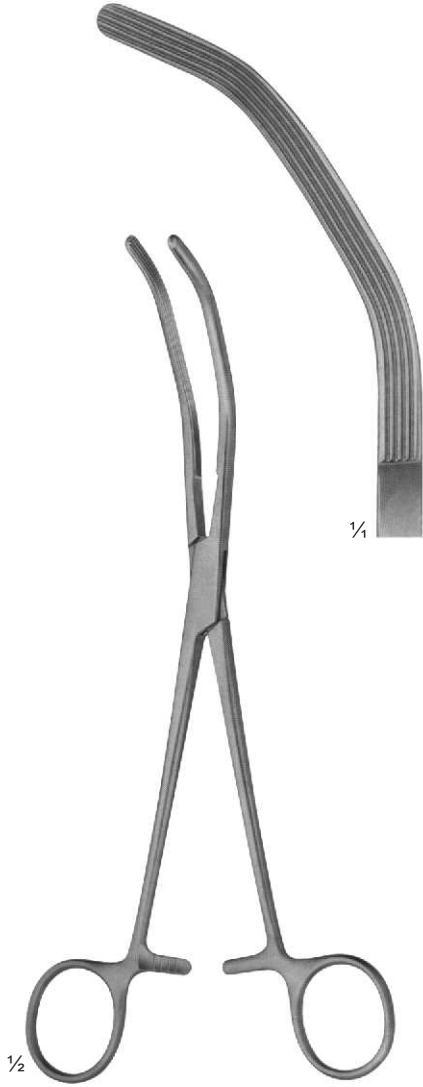

10-223
HERRICK
225 mm

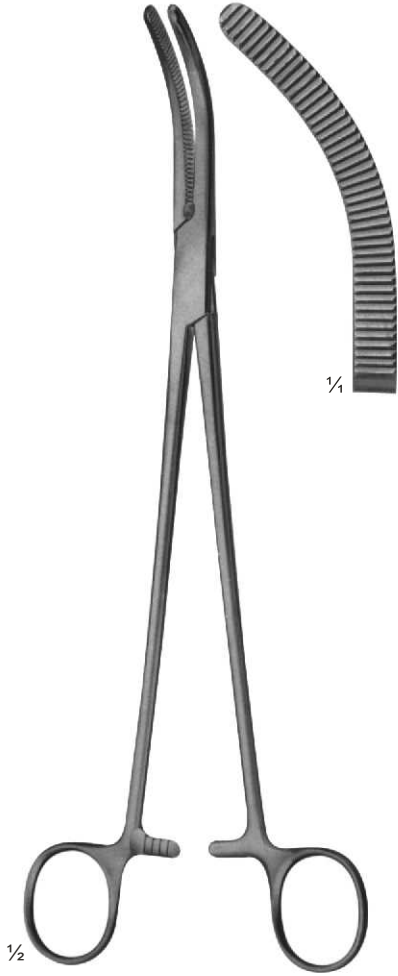

10-224
WERTHEIM
225 mm

Kidney Elevating Forceps



1/2

10-225
COLLIN
285 mm



1/2

10-226
DARTIGUES
255 mm

Kidney Stone Forceps



10-227



10-228



10-229



$\frac{1}{4}$
10-230



10-231



10-232



$\frac{1}{4}$
10-233



$\frac{1}{2}$

10-227 - 230
RANDALL
225 mm



$\frac{1}{2}$

10-231 - 233
RANDALL
190 mm

Bladder Retractors

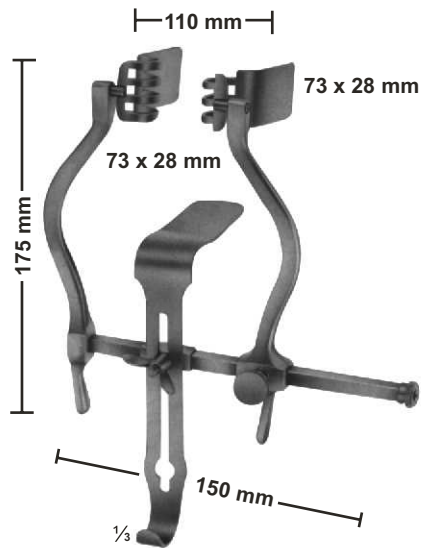

11-101
JUDD-MASSON
Bladder and suprapubic
retractor



11-102
MILLIN
Bladder retractor
105X45 mm



11-103
LEGUEU
Bladder retractor
Center blade
80 x 31 mm

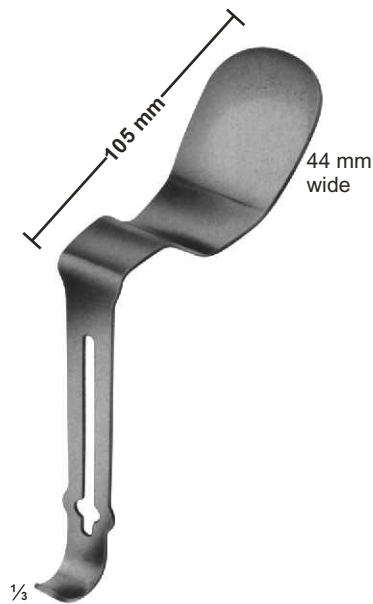

11-104
MILLIN
Center bladder for
retro pubic prostatectomy

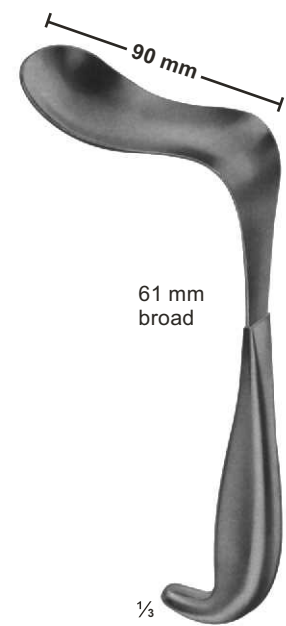

11-105
KOCHER
Bladder spatula
235 mm

Genito-Urinary Instruments-Prostatectomy



11-106
MATHIEU
 Foreign body forceps
 Length of shaft
 190 mm

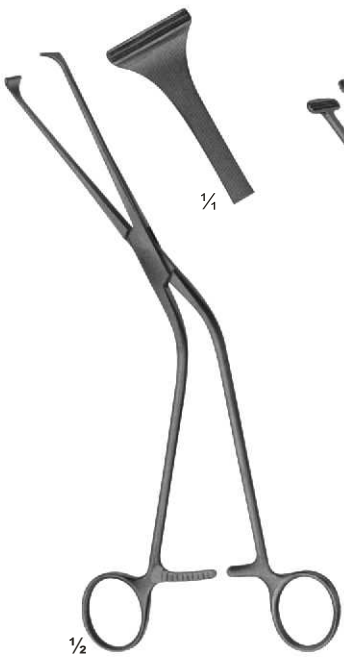

11-107
MILLIN
 Lobe grasping
 forceps
 245 mm

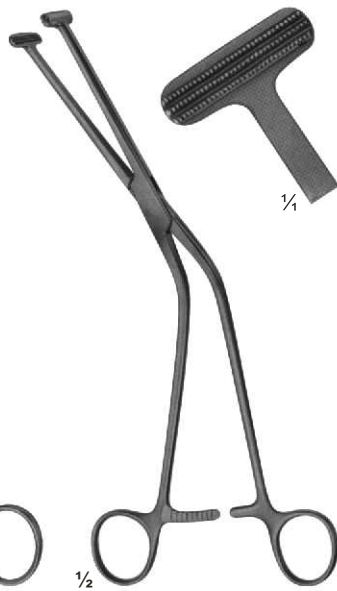

11-108
MILLIN
 Lobe grasping
 forceps
 235 mm



11-109
MILLIN
 Bladder neck spreader
 285 mm

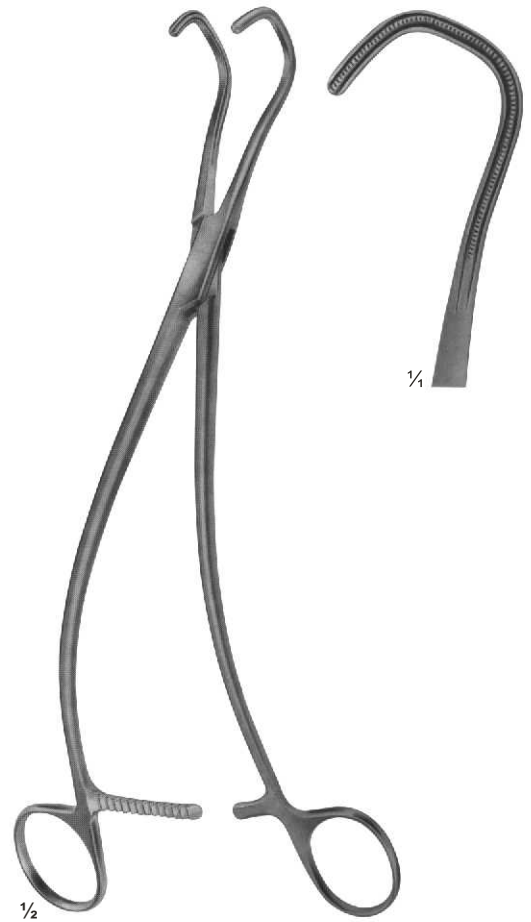

11-110
Ureter forceps
 240 mm

Genito-Urinary Instruments



11-111
GUYON
Catheter guide
(introducer)
365 mm

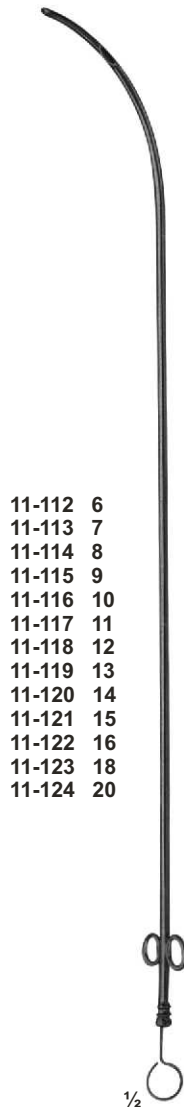

- 11-112 6
- 11-113 7
- 11-114 8
- 11-115 9
- 11-116 10
- 11-117 11
- 11-118 12
- 11-119 13
- 11-120 14
- 11-121 15
- 11-122 16
- 11-123 18
- 11-124 20

11-112 - 124
Female catheters,
metal
160 mm



- 11-125 8
- 11-126 9
- 11-127 10
- 11-128 11
- 11-129 12
- 11-130 13
- 11-131 14
- 11-132 15
- 11-133 16
- 11-134 17
- 11-135 18
- 11-136 19
- 11-137 20
- 11-138 21
- 11-139 22
- 11-140 23
- 11-141 24
- 11-142 25
- 11-143 26
- 11-144 27
- 11-145 28
- 11-146 29
- 11-147 30

11-125 - 147
Urethral bougies
and dilating sounds
345 mm

- 11-148 Ben. 24/Charr. 12
- 11-149 Ben. 25
- 11-150 Ben. 26/Charr. 13
- 11-151 Ben. 27
- 11-152 Ben. 28/Charr. 14
- 11-153 Ben. 29
- 11-154 Ben. 30/Charr. 15
- 11-155 Ben. 31
- 11-156 Ben. 32/Charr. 16
- 11-157 Ben. 33
- 11-158 Ben. 34/Charr. 17
- 11-159 Ben. 35
- 11-160 Ben. 36/Charr. 18
- 11-161 Ben. 37
- 11-162 Ben. 38/Charr. 19
- 11-163 Ben. 39
- 11-164 Ben. 40/Charr. 20
- 11-165 Ben. 41
- 11-166 Ben. 42/Charr. 21
- 11-167 Ben. 43
- 11-168 Ben. 44/Charr. 22
- 11-169 Ben. 45
- 11-170 Ben. 46/Charr. 23
- 11-171 Ben. 47
- 11-172 Ben. 48/Charr. 24
- 11-173 Ben. 49
- 11-174 Ben. 50/Charr. 25
- 11-175 Ben. 51
- 11-176 Ben. 52/Charr. 26
- 11-177 Ben. 53
- 11-178 Ben. 54/Charr. 27
- 11-179 Ben. 55
- 11-180 Ben. 56/Charr. 28
- 11-181 Ben. 57
- 11-182 Ben. 58/Charr. 29
- 11-183 Ben. 59
- 11-184 Ben. 60/Charr. 30

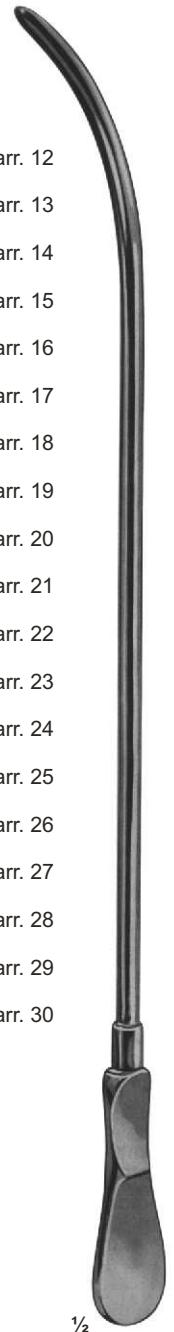

11-148 - 184
Urethral bougies
and dilating sounds
255 mm

Genito-Urinary Instruments & Circumcision Clamps



11-185
GUYON
Set of urethral bougies and dilating sounds,
in metal case, with lift out rack and bottom
rack, containing 21 urethral and dilating sounds.

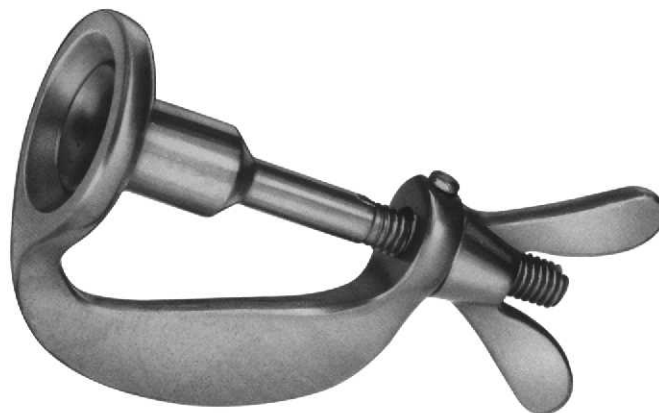

11-186
WINKELMANN
Circumcision Clamps
12 mm / 16 mm / 20 mm

Trocars



11-187
KLIMA ROSEGGER
35 X 1,8 mm
Sternal puncture needle

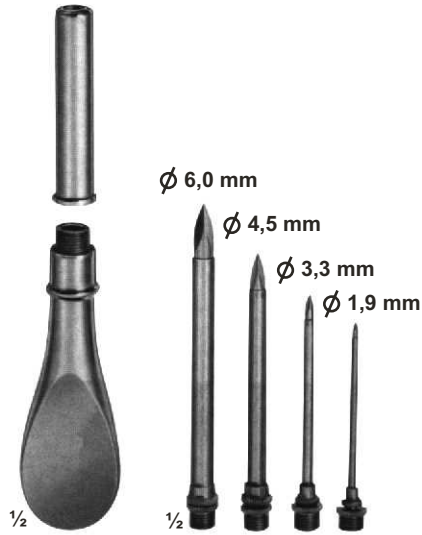

11-188
Universal trocar
with 4 tips



11-189 - 193
Inside dime. Outside dime
11-189 2,2 mm 3,0 mm
11-190 3,0 mm 4,0 mm
11-191 4,0 mm 5,0 mm
11-192 5,0 mm 6,0 mm
11-193 5,5 mm 6,5 mm
for hydrocele and abdominal
puncture



11-194 - 197
Inside dime. Outside dime
11-194 2,2 mm 3,0 mm
11-195 3,0 mm 4,0 mm
11-196 4,0 mm 5,0 mm
11-197 5,0 mm 6,0 mm
for abdominal puncture,
with stop-cock and lateral
drain

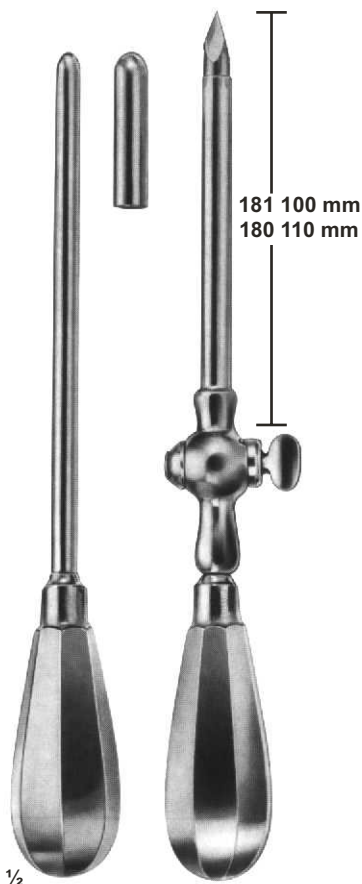

11-198 - 199
Inside dime. Outside dime
11-198 6,5 mm 8,0 mm
11-199 9,0 mm 10,0 mm
Empyema trocar

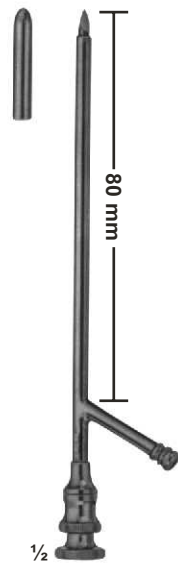

11-200 - 203
Inside dime. Outside dime
11-200 3,0 mm 4,0 mm
11-201 3,6 mm 4,6 mm
11-202 4,3 mm 5,3 mm
11-203 5,0 mm 6,0 mm
Gall bladder trocars



11-204
PIERCE
Antrum trocar
4,0 mm



11-205
COAKLEY
Antrum trocar
3,0 mm

Vaginal specula



12-101
COLLIN
for children
53 x 10 mm

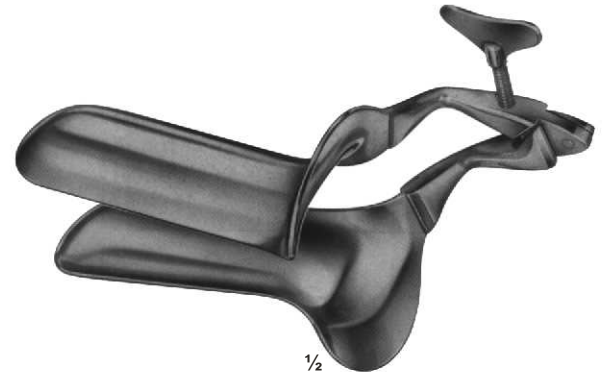

12-102 - 105
COLLIN

12-102	100/90mm	28 mm
12-103	100/90mm	32 mm
12-104	105/95mm	35 mm
12-105	115/105mm	40 mm
Total length/working length		width

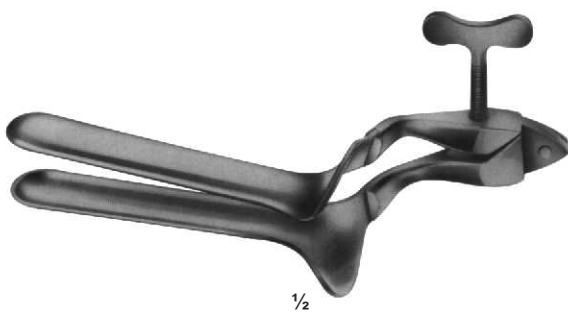

12-106
COLLIN
for virgins
95/85 x 18 mm



12-107
CUSCO
for virgins
75 x 17 mm



12-108
CUSCO
for virgins
75 x 17 mm

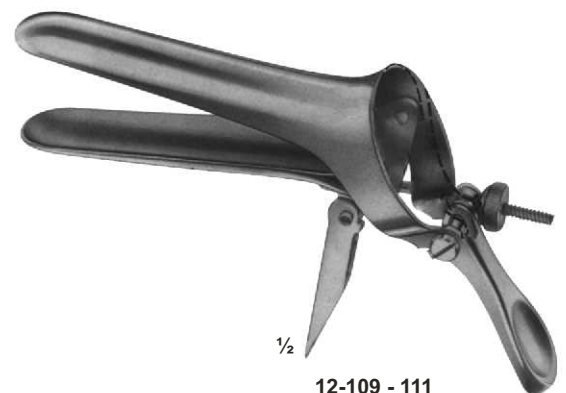

12-109 - 111
CUSCO

12-109	92X23-25 mm
12-110	100x25-27 mm
12-111	110x27-30 mm

Vaginal Specula



1/2

12-112 - 115
CUSCO
STANDARD
12-112 80X24 mm
12-113 80X32 mm
12-114 90X36 mm
12-115 110X37 mm



1/2

12-116 - 119
CUSCO
12-116 80X24 mm
12-117 80X32 mm
12-118 90X36 mm
12-119 110X37 mm



1/2

12-120 - 122
CUSCO
12-120 80X24 mm
12-121 80X32 mm
12-122 115X36 mm



1/2

12-123 - 124
SEYFFERT
12-123 100X24 mm
12-124 110X32 mm
230 mm



1/2

12-125
SEMM
for children
and virgins
180 mm

Vaginal Specula, Sets, Upper & Lower Blades



12-126 - 128
GRAVE
12-126 75X20 mm
12-127 95X30 mm
12-128 105X33 mm

1/2



12-129 - 130
PEDERSON
12-129 100X22 mm
12-130 120X25 mm

1/2



12-131 - 132
BRIESKY
12-131 72X25 mm / 77X30 mm
12-132 75X30 mm / 92X38 mm
170 mm

1/2



1/2

12-133 - 134
BRIESKY
12-133 100X22 mm
77 X30 mm
140 mm
12-134 120X25 mm
92 X38 mm
170 mm



1/2

12-135 - 137
SEIDL
12-135 80X8 mm
12-136 80X10 mm
12-137 90X14 mm
For children and infants
170 mm



1/2

12-138
KRISTELLER
70X15 mm, (170 mm)
For children



1/2

12-139 - 141
SIMS
12-139 70X26 mm
75 X30 mm 125 mm
12-140 75X30 mm
80 X85 mm 150 mm
11-141 80X36 mm
90 X40 mm 175 mm

Vaginal Specula-Sets, upper and lower blades



12-142 - 146
KRISTELLER
12-142 110X18 mm
12-143 110X20 mm
12-144 110X27 mm
12-145 110X30 mm
12-146 110X36 mm
220 mm

12-147 - 150
KRISTELLER
Upper blades

12-151 - 154
KRISTELLER
Lower blades

Vaginal Specula-upper and lower blades



12-155 115X14 mm
215 mm

12-156 115X23 mm
215 mm

12-157 115X16 mm
220 mm

12-158 115X26 mm
220 mm

12-159 120X30 mm
225 mm

12-155 - 159
KRISTELLER
Upper blades

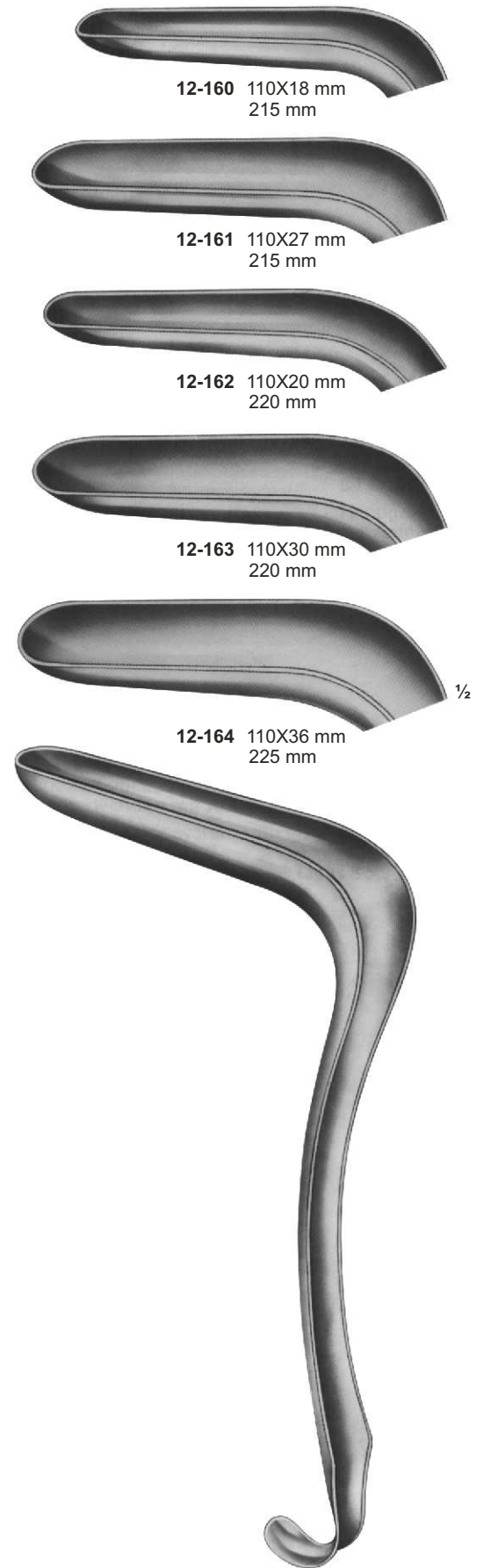

12-160 110X18 mm
215 mm

12-161 110X27 mm
215 mm

12-162 110X20 mm
220 mm

12-163 110X30 mm
220 mm

12-164 110X36 mm
225 mm

12-160 - 164
KRISTELLER
Lower blades

Vaginal Specula

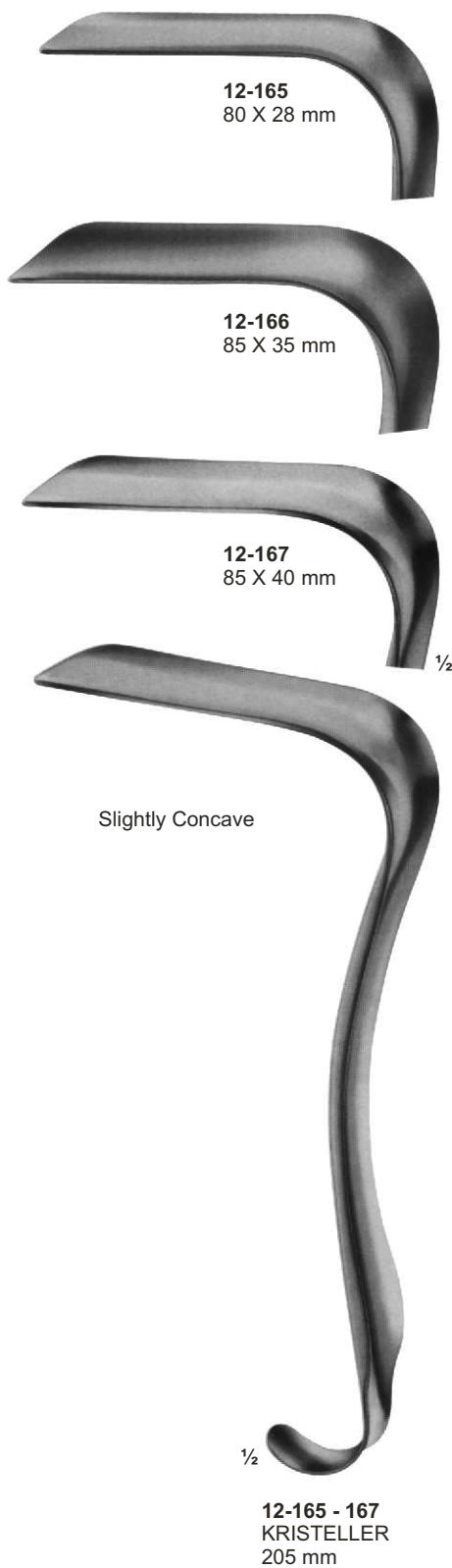

Vaginal Specula-for children & virgins / Vario Retractor

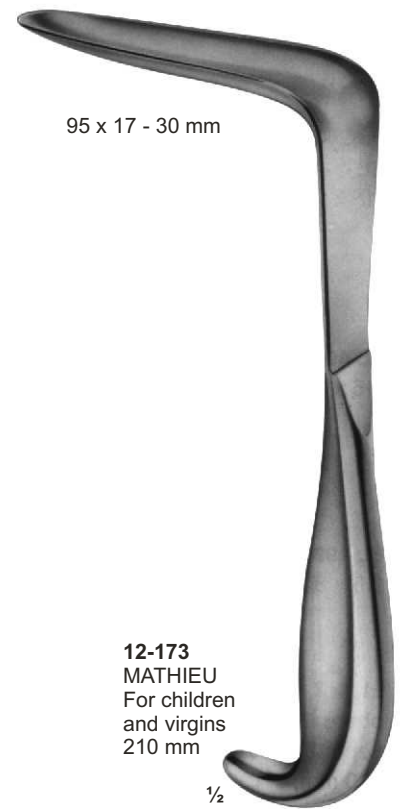

Vaginal Specula-for children and virgins



Vaginal Specula / Retractors



1/2

12-190 - 194
BREISKY
WIENER MODELL/
VIENNA PATTERN
12-190 100 X 20 mm
12-191 100 X 25 mm
12-192 100 X 30 mm
12-193 100 X 35 mm
12-194 100 X 40 mm
300 mm



1/2

12-195 - 199
BREISKY
WIENER MODELL/
VIENNA PATTERN
12-195 130 X 20 mm
12-196 130 X 25 mm
12-197 130 X 30 mm
12-198 130 X 35 mm
12-199 130 X 40 mm
320 mm



1/2

12-200 - 201
WEISSBARTH
12-200 80 X 28 mm
12-201 85 X 42 mm
210 mm



1/2

12-202
DOYEN
lateral speculum
80 x 30 mm
250 mm

Vaginal & Wound Retractor / Vaginal Specula



12-203
SIMON
115 X 22 mm
275 mm



12-204
AUVARD
65 X 38 mm - 28 mm
1,530 kg
with fixed weight
230 mm



12-205 - 206
AUVARD
12-205 75 X 42 mm
(40 mm)
12-206 105 X 43 mm
(40 mm)
with detachable wight
230 mm



12-207
MARTIN
with hook shaped
handle for hanging
in weights
270 mm

Vaginal Speculas

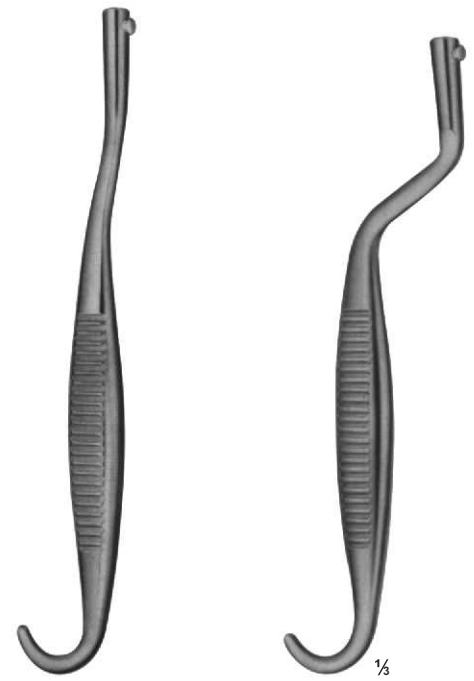
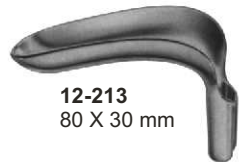

Vaginal Retractors



$\frac{1}{2}$
12-221
JOLL (FRIEDMAN)
155 mm



$\frac{1}{4}$
 $\frac{1}{2}$
12-222
RICHTER
170 mm



$\frac{1}{4}$
 $\frac{1}{2}$
12-223
GELPI
135 mm



$\frac{1}{4}$
 $\frac{1}{2}$
12-224
GELPI
175 mm

Uterine Dilators



13-101 - 143
HEGAR
with very conical point
185 mm

13-101	1	mm	13-123	23	mm
13-102	2	mm	13-124	24	mm
13-103	3	mm	13-125	25	mm
13-104	4	mm	13-126	26	mm
13-105	5	mm	13-127	1	½mm
13-106	6	mm	13-128	2	½mm
13-107	7	mm	13-129	3	½mm
13-108	8	mm	13-130	4	½mm
13-109	9	mm	13-131	5	½mm
13-110	10	mm	13-132	6	½mm
13-111	11	mm	13-133	7	½mm
13-112	12	mm	13-134	8	½mm
13-113	13	mm	13-135	9	½mm
13-114	14	mm	13-136	10	½mm
13-115	15	mm	13-137	11	½mm
13-116	16	mm	13-138	12	½mm
13-117	17	mm	13-139	13	½mm
13-118	18	mm	13-140	14	½mm
13-119	19	mm	13-141	15	½mm
13-120	20	mm	13-142	16	½mm
13-121	21	mm	13-143	17	½mm
13-122	22	mm			



13-144 - 152
HEGAR
205 mm

13-144	1+2	mm
13-145	3+4	mm
13-146	5+6	mm
13-147	7+8	mm
13-148	9+10	mm
13-149	11+12	mm
13-150	13+14	mm
13-151	15+16	mm
13-152	17+18	mm

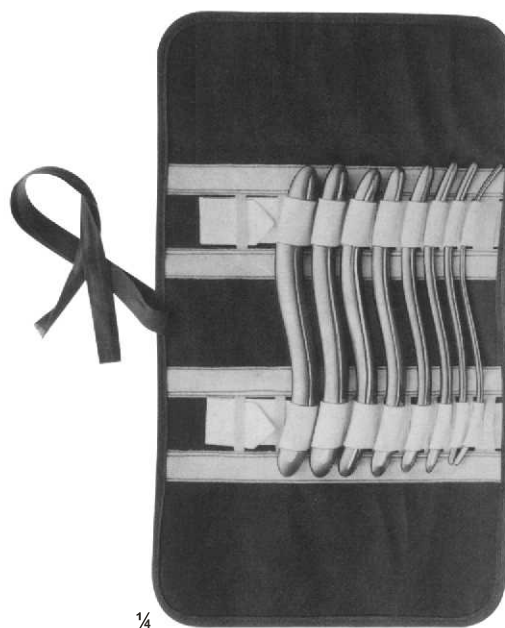

13-153
HEGAR
Uterine dilator set, in canvas
roll with 8 dilators.

Uterine Dilators - Complete Sets



13-154
HEGAR
Dilator set consisting of:
14 Dilators,
1 Rack for dilators (4 - 12 mm)
1 Rack for Dilators (13 - 17 mm)
1 Metal case only,
with hinged lid, stainless 200 X 100 X 35 mm

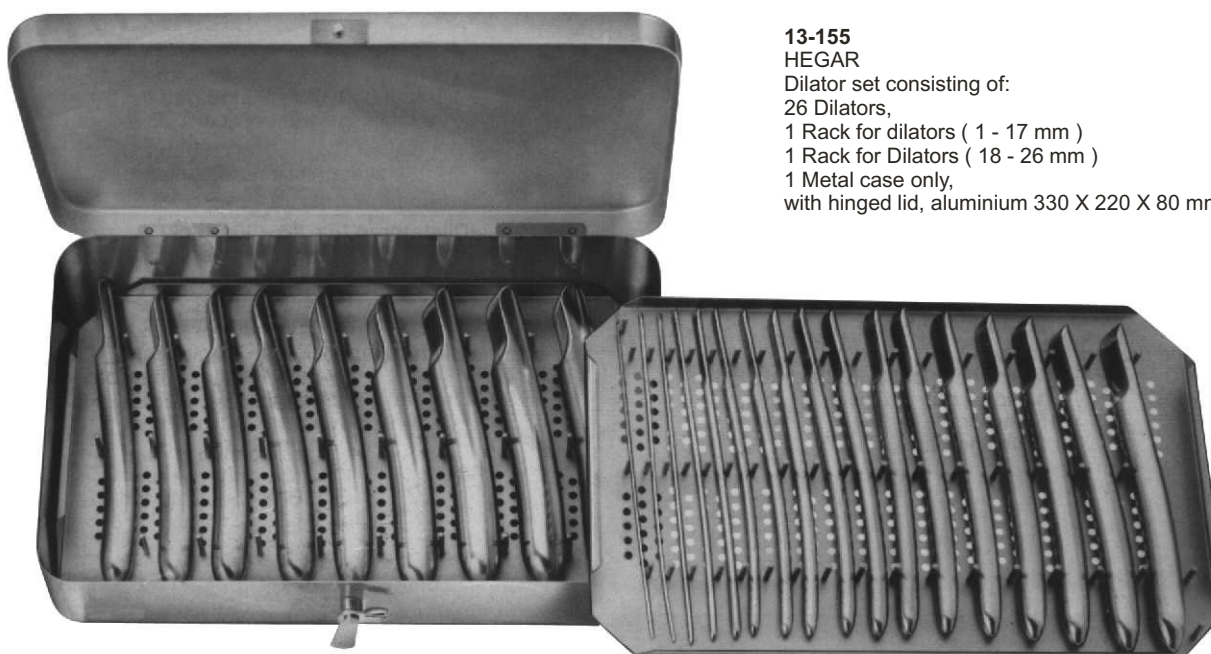

13-155
HEGAR
Dilator set consisting of:
26 Dilators,
1 Rack for dilators (1 - 17 mm)
1 Rack for Dilators (18 - 26 mm)
1 Metal case only,
with hinged lid, aluminium 330 X 220 X 80 mm

Endospecula For Cervix

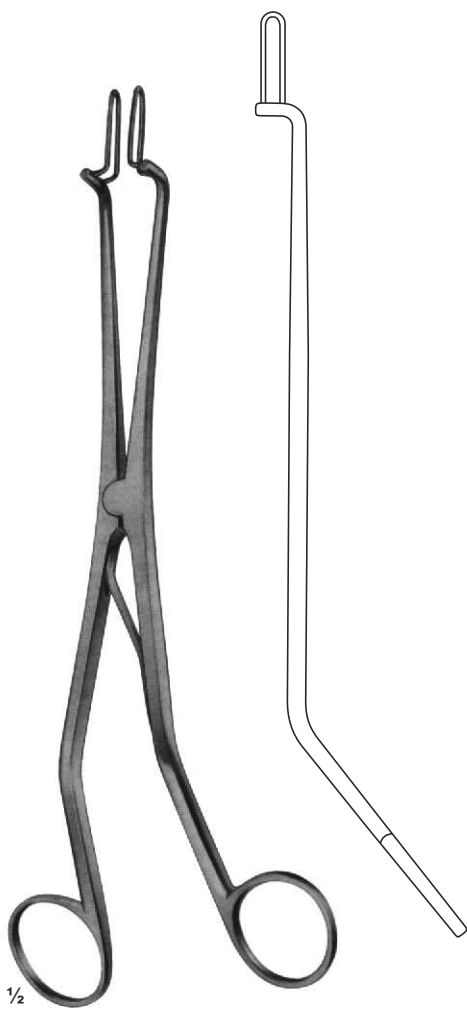

13-156
KOGAN
Endospecula for cervix
and urethra, without ratchet
240 mm

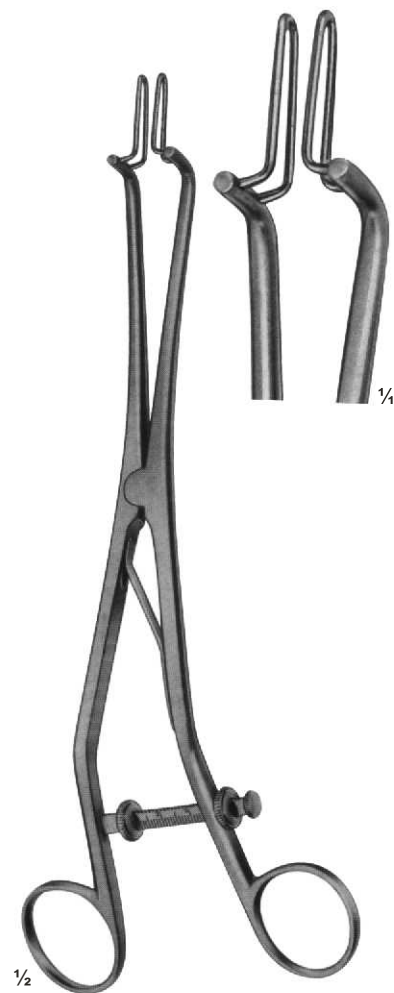

13-157
KOGAN
Endospecula for cervix
and urethra, with
scale-ratchet and fixing screws
240 mm

Uterine Probes



14-101
MAYO
biegsam malleable
330 mm



14-102
SIMS
biegsam malleable
330 mm



14-103
MARTIN
330 mm



14-104
SIMPSON
malleable
silver-plated
290 mm



14-105
BRAUN
Uterine
depressor
270 mm



14-106
Cotton
applicator
270 mm

Uterine Dressing Forceps



14-107
PELKMANN
260 mm

14-108
PELKMANN
260 mm

14-109
BOZEMANN
250 mm

14-110
BOZEMANN
255 mm

Jaws with longitudinal groove

Uterine Dressing Forceps

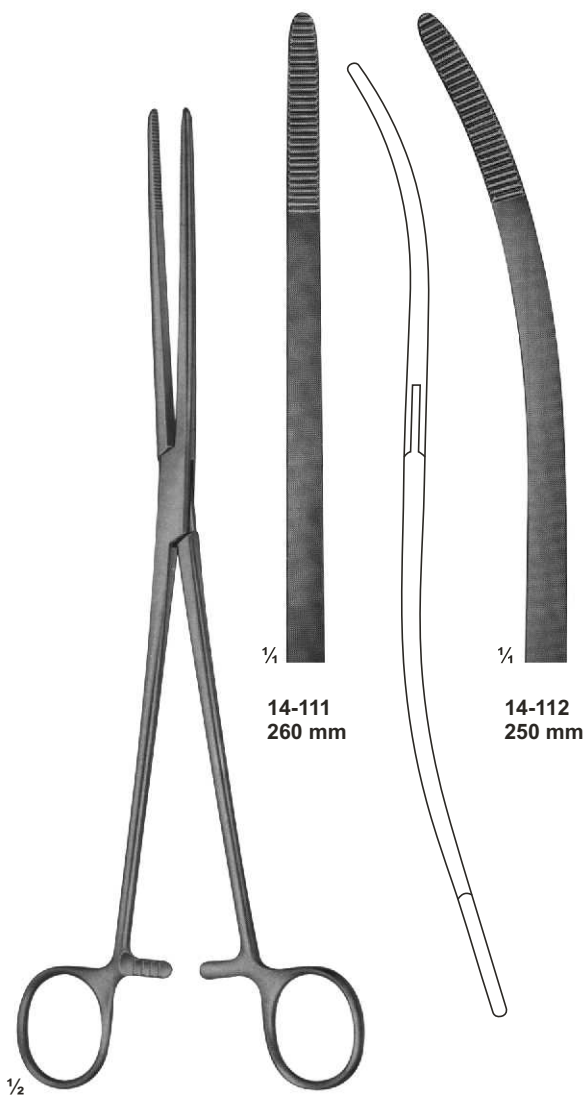

14-111
260 mm

14-112
250 mm

14-111 - 112
BOZEMANN

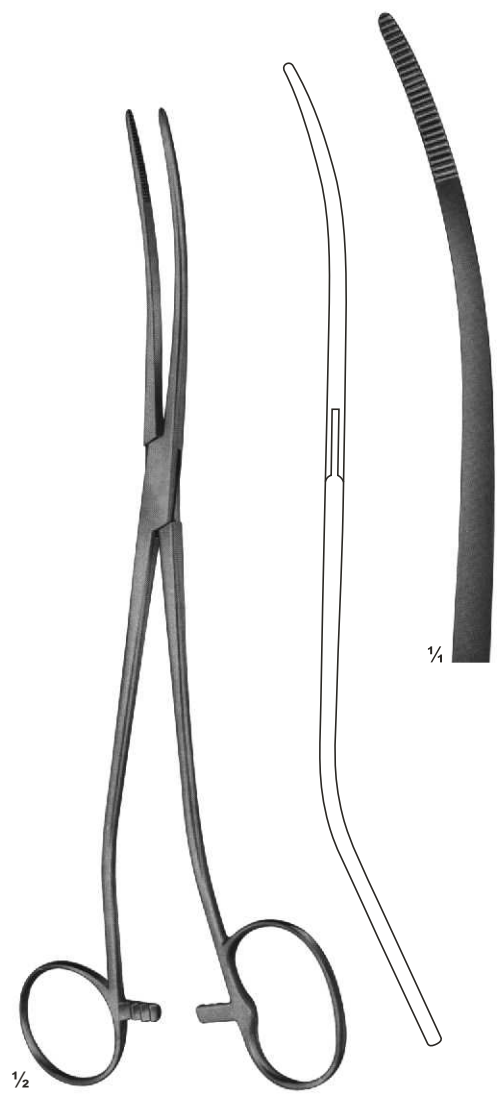

14-113
BOZEMANN-DOUGLAS
260 mm

Uterine Tenaculum Forceps

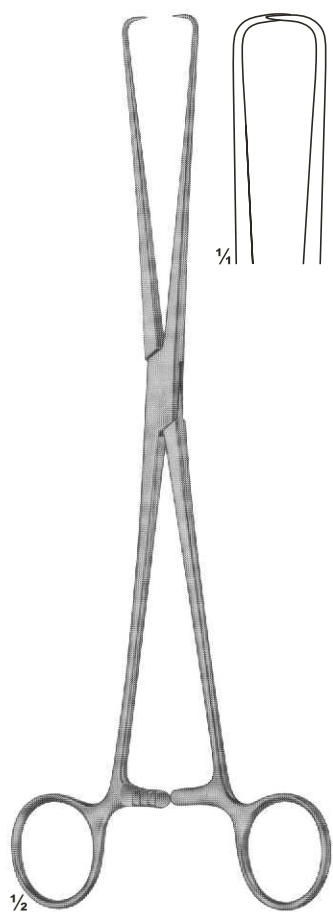

14-114
BRAUN
slender type
250 mm



14-115
SCHRODER
250 mm



14-116
POZZI
heavy type
255 mm

Uterine Tenaculum Forceps

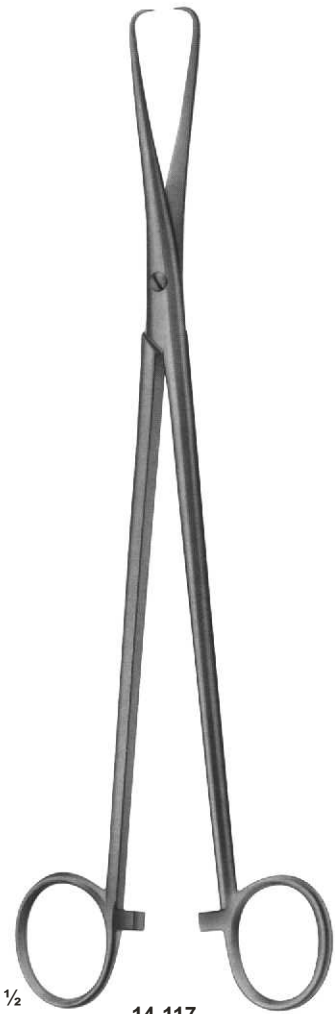

14-117
265 mm

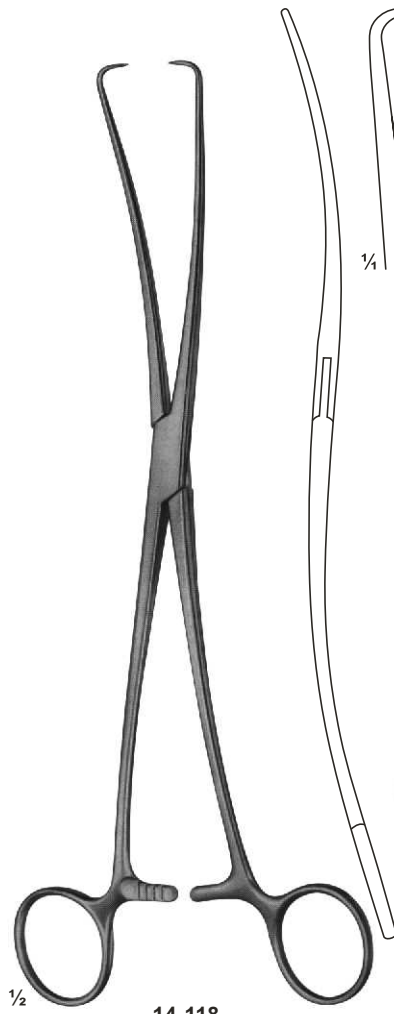

14-118
DUPLAY
250 mm

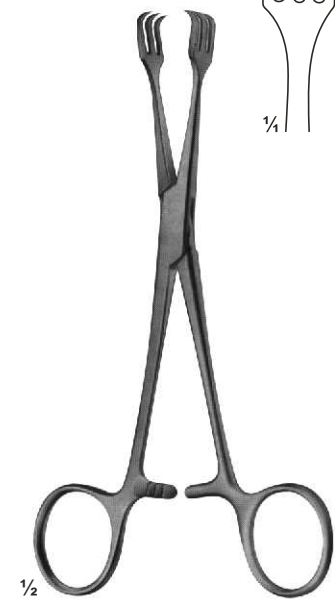

14-119
LAHEY
155 mm



1/4

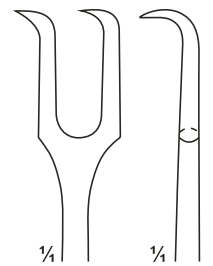

1/4

1/4

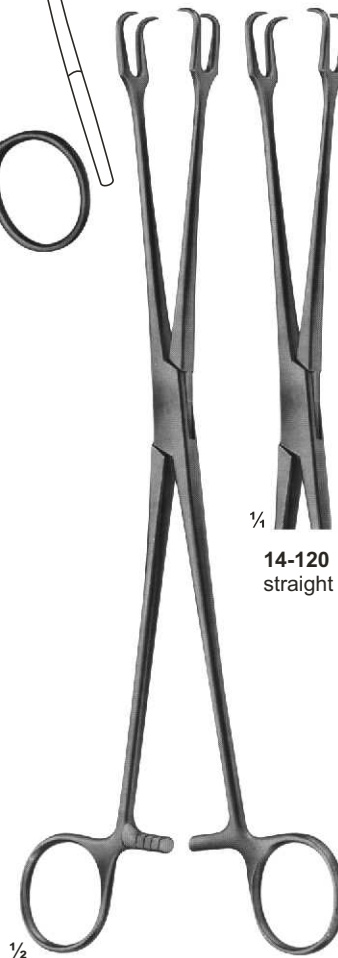

14-120 - 122
SCHRODER
250 mm



14-120
straight



14-121
curved
on flat



14-122
curved
sideways

Uterine Tenaculum Forceps

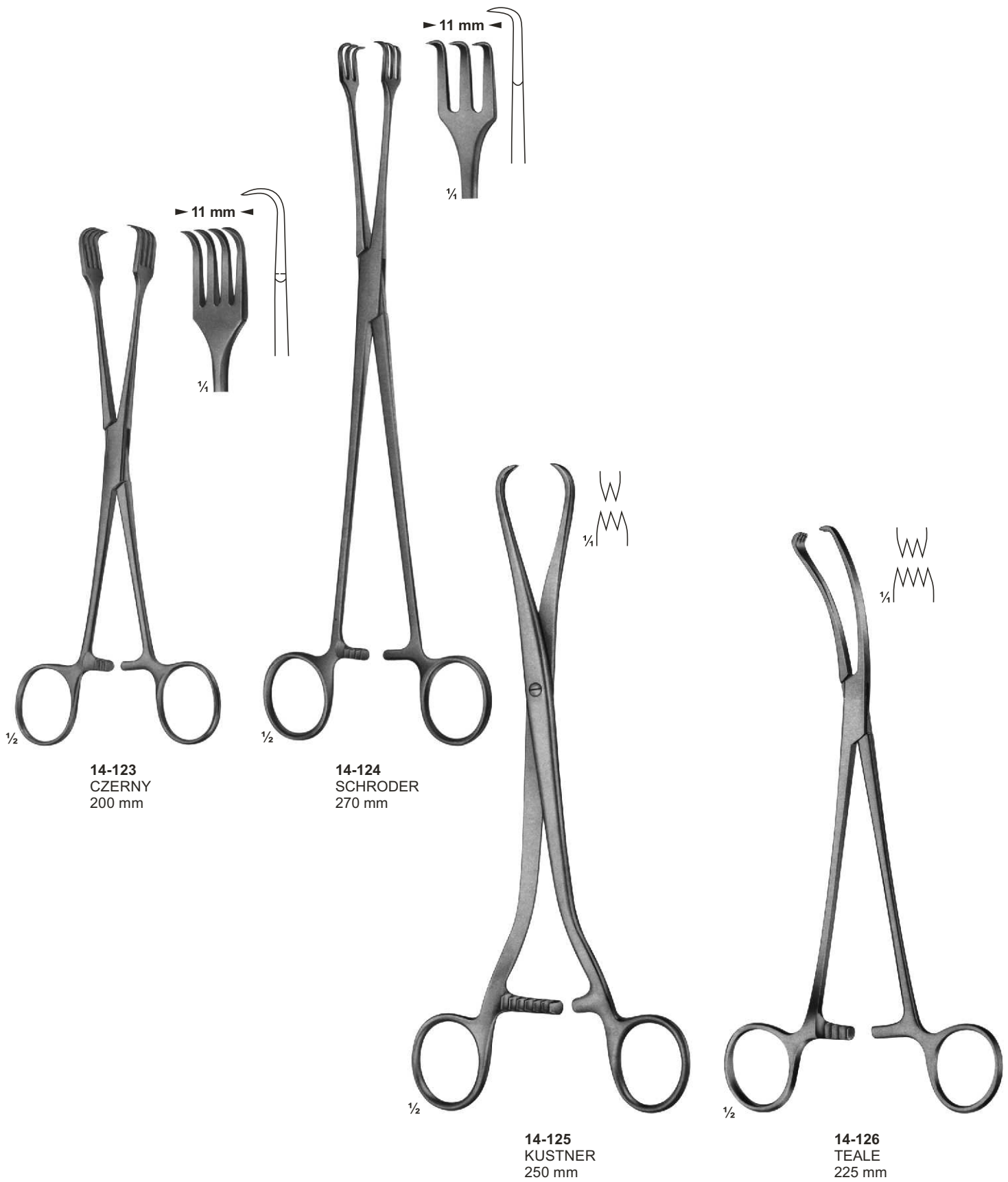

Uterine Tenaculum Forceps

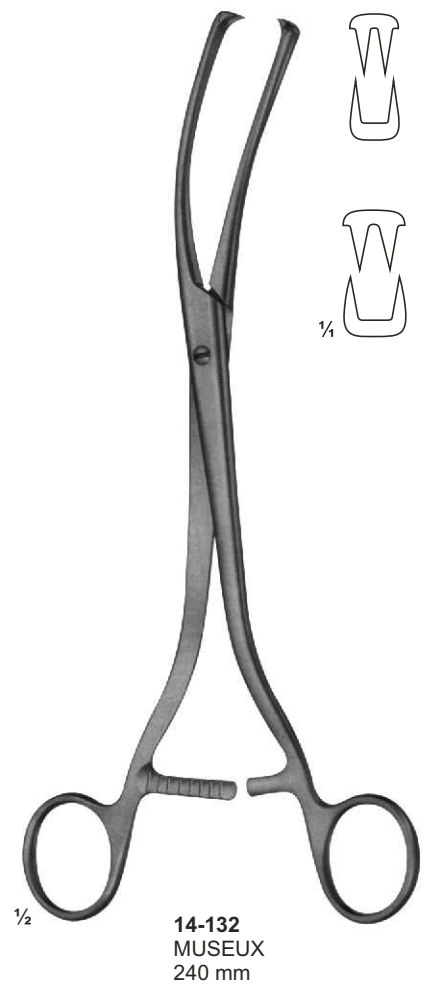
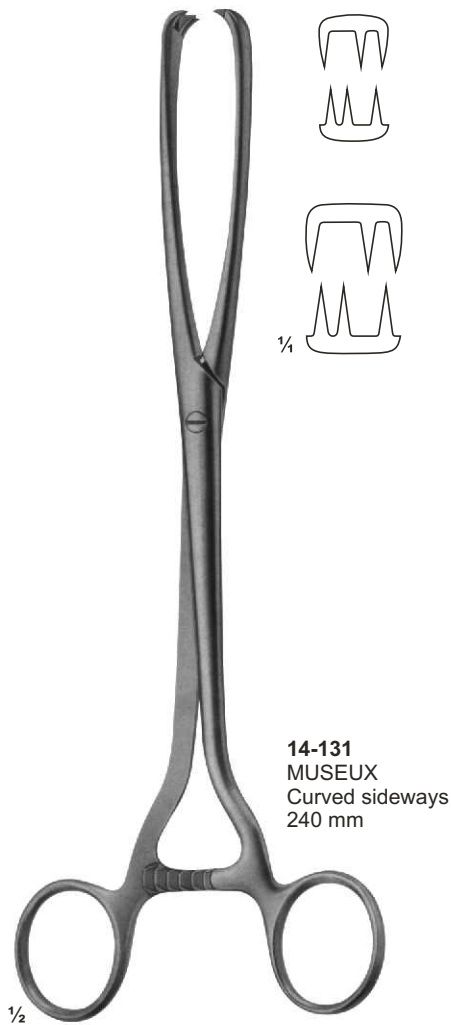
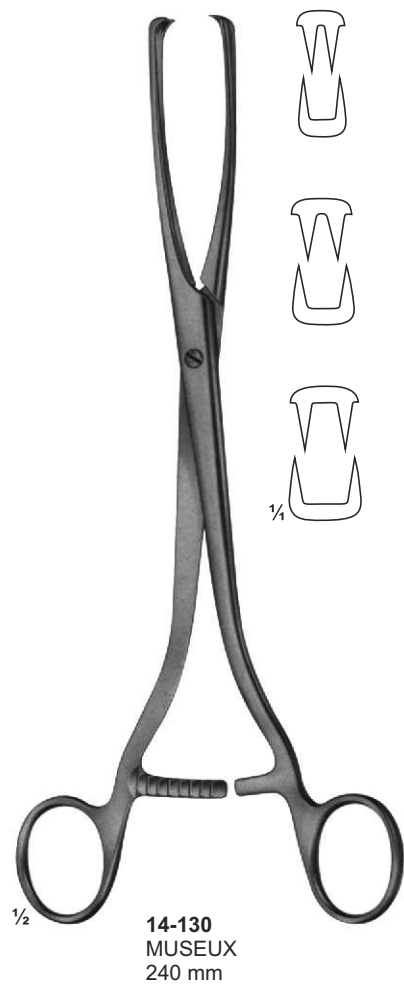

Polypus-and Ovum Forceps

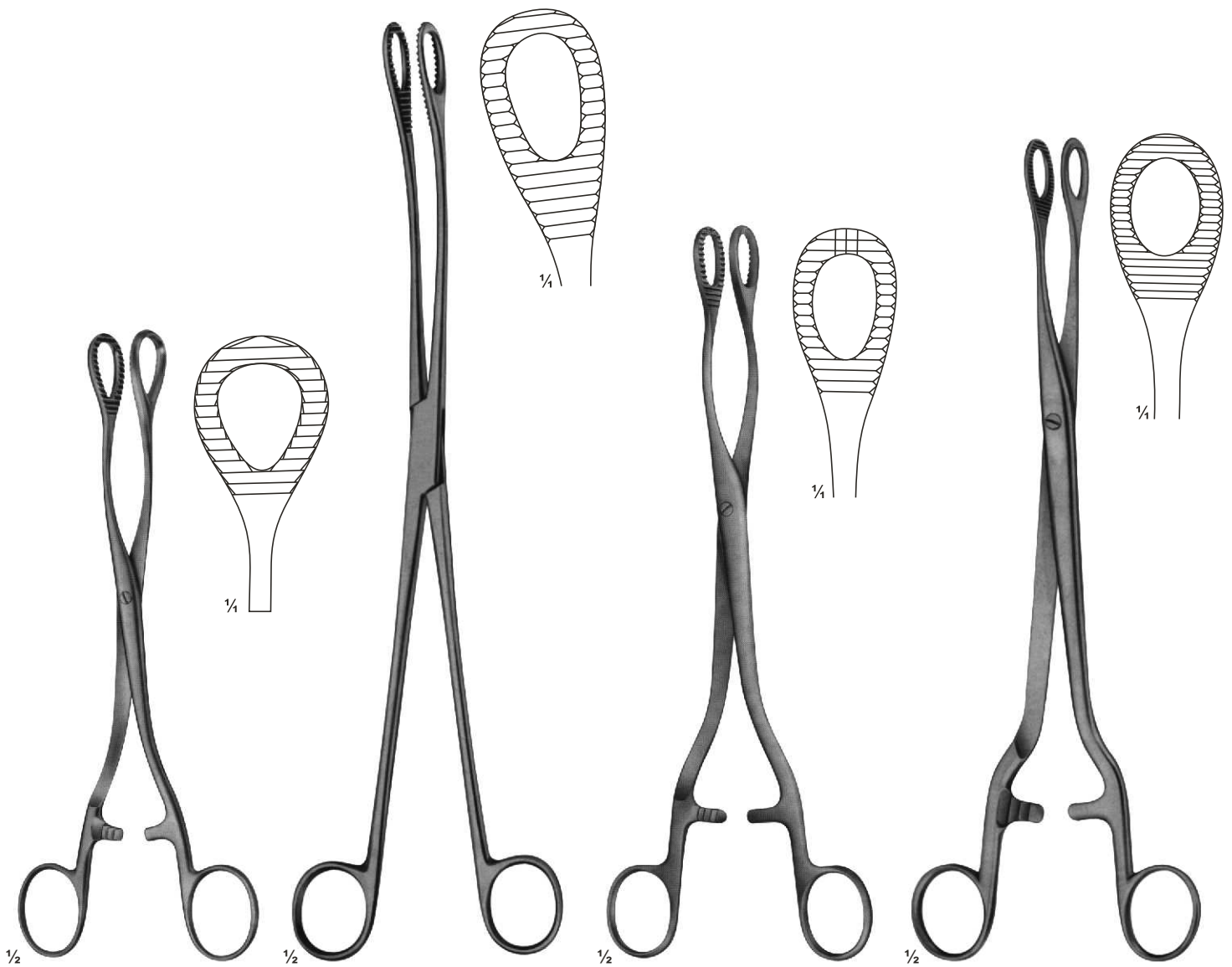

14-133
HEYWOOD-SMITH
200 mm

14-134
KELLY
320 mm

14-135
HEYWOOD-SMITH
250 mm

14-136
NOTO
280 mm

Polypus and Ovum Forceps

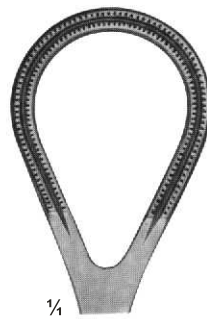
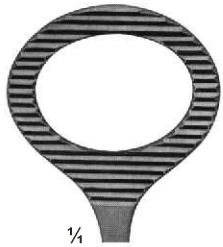

14-138

14-139



14-137
DOYEN
185 mm



14-138 - 139
250 mm 270 mm



14-140
BUMM
280 mm

Uterine Elevating Forceps

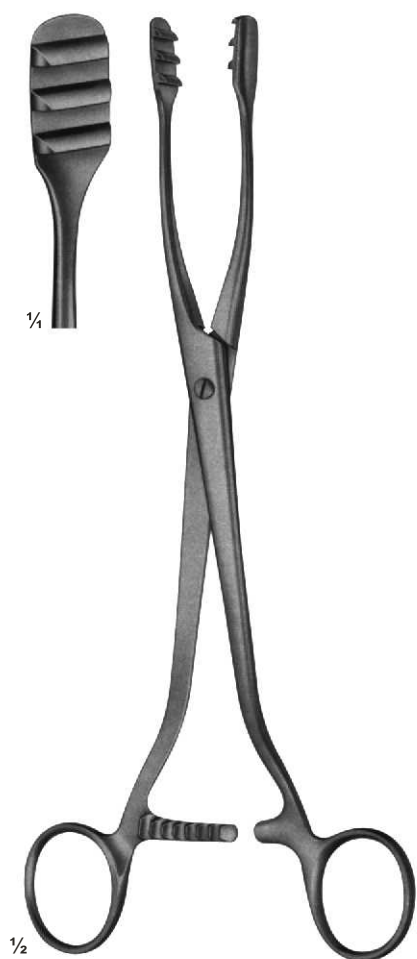

14-141
COLLIN
250 mm



14-142
COLLIN
285 mm



14-143
DARTIGUES
255 mm

Uterine Elevating Forceps



14-144
SOMMER
235 mm



14-145
STRASSMANN
260 mm

Uterine Elevating Forceps

With movable jaws



14-146
COLLIN
265 mm

With movable jaws



14-147
260 mm

Myoma Instruments



14-148
SEGOND
Myomatome
270 mm



14-149
DOYEN
Myoma screw
150 mm



14-150
DOYEN
Myoma screw
190 mm

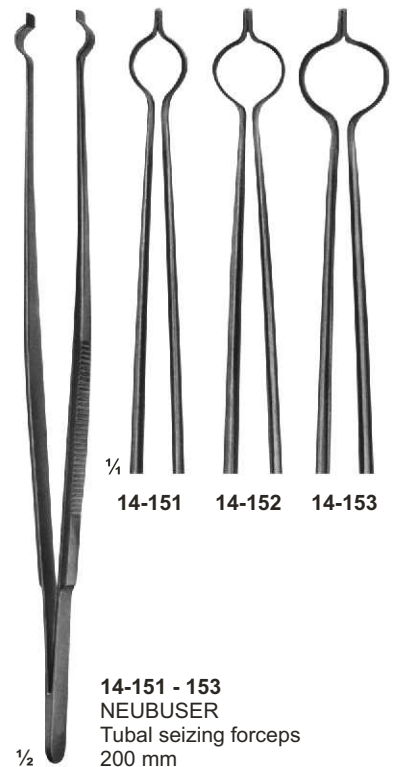

14-151 **14-152** **14-153**

14-151 - 153
NEUBUSER
Tubal seizing forceps
200 mm

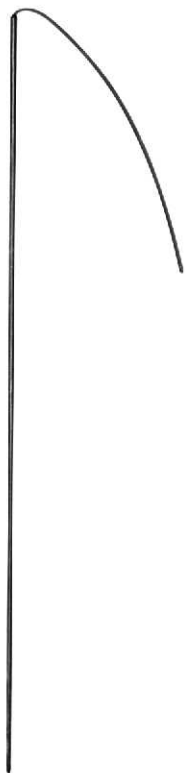

14-154
Splint guide
with thread



14-155
Splint guide with
round handle
180 mm



14-156
Angled glass rods
Set . 3 pieces

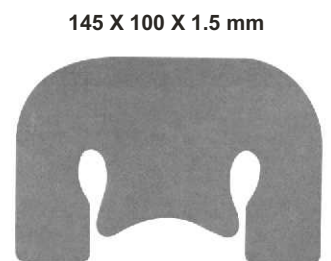

145 X 100 X 1.5 mm

14-157
Silicon operating pad
pre-cut

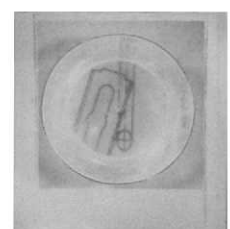

14-158
Polyaethylen splint material
soft-sterile
0.45 mm

Biopsy Curettes

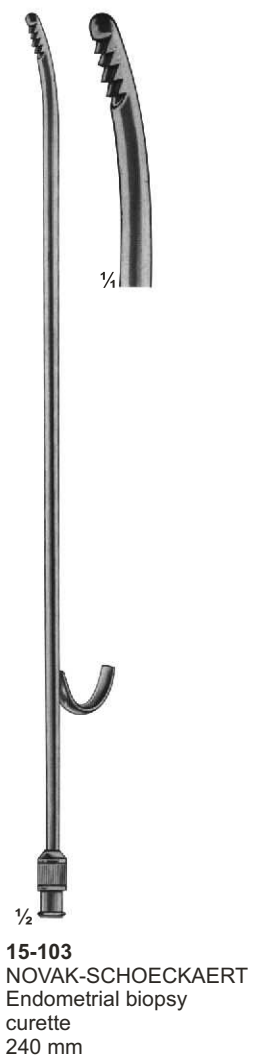
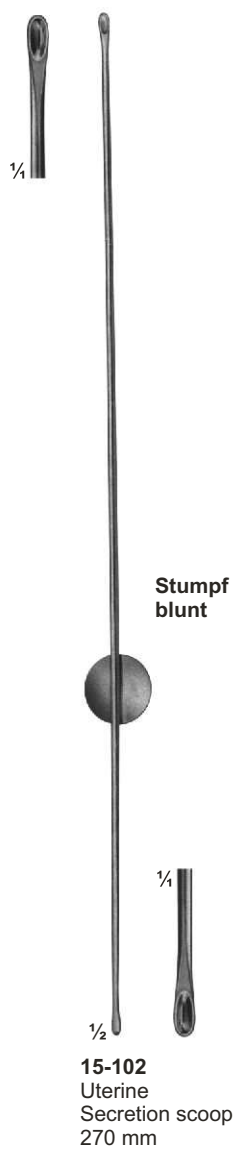
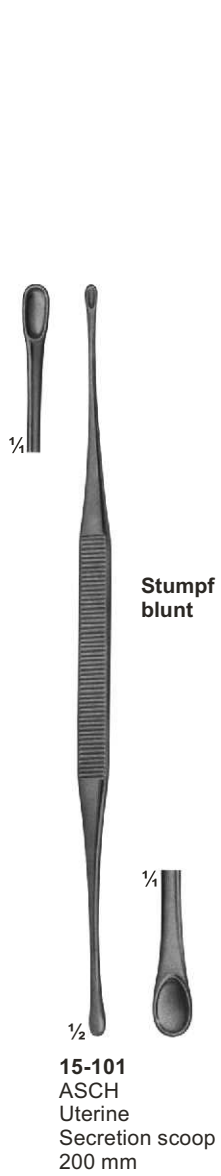

Biopsy Forceps

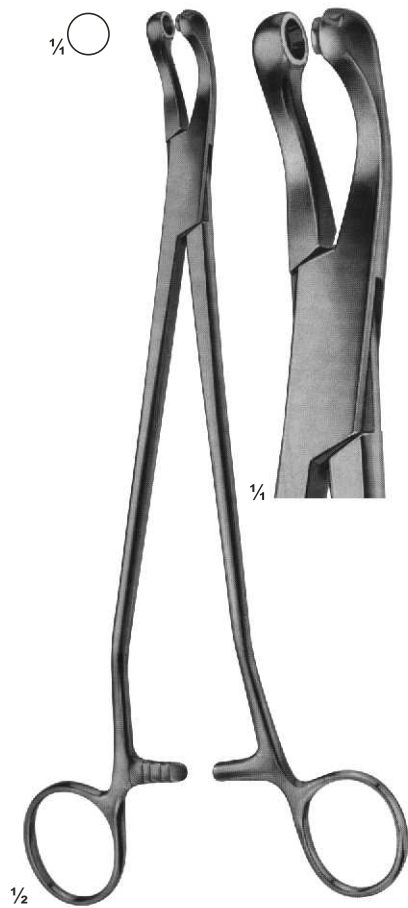

15-105
THOMS-GAYLOR
240 mm



15-106
SCHUBERT
260 mm

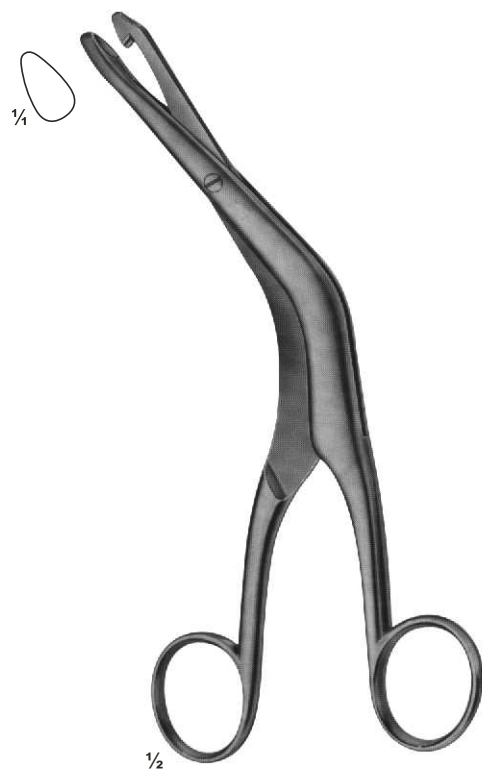

15-107
FAURE
210 mm

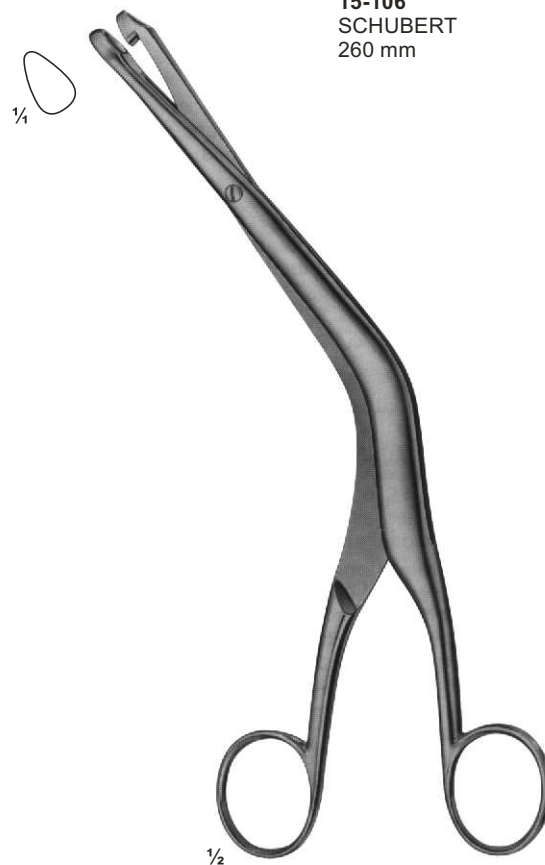

15-108
FAURE
240 mm

Biopsy Forceps

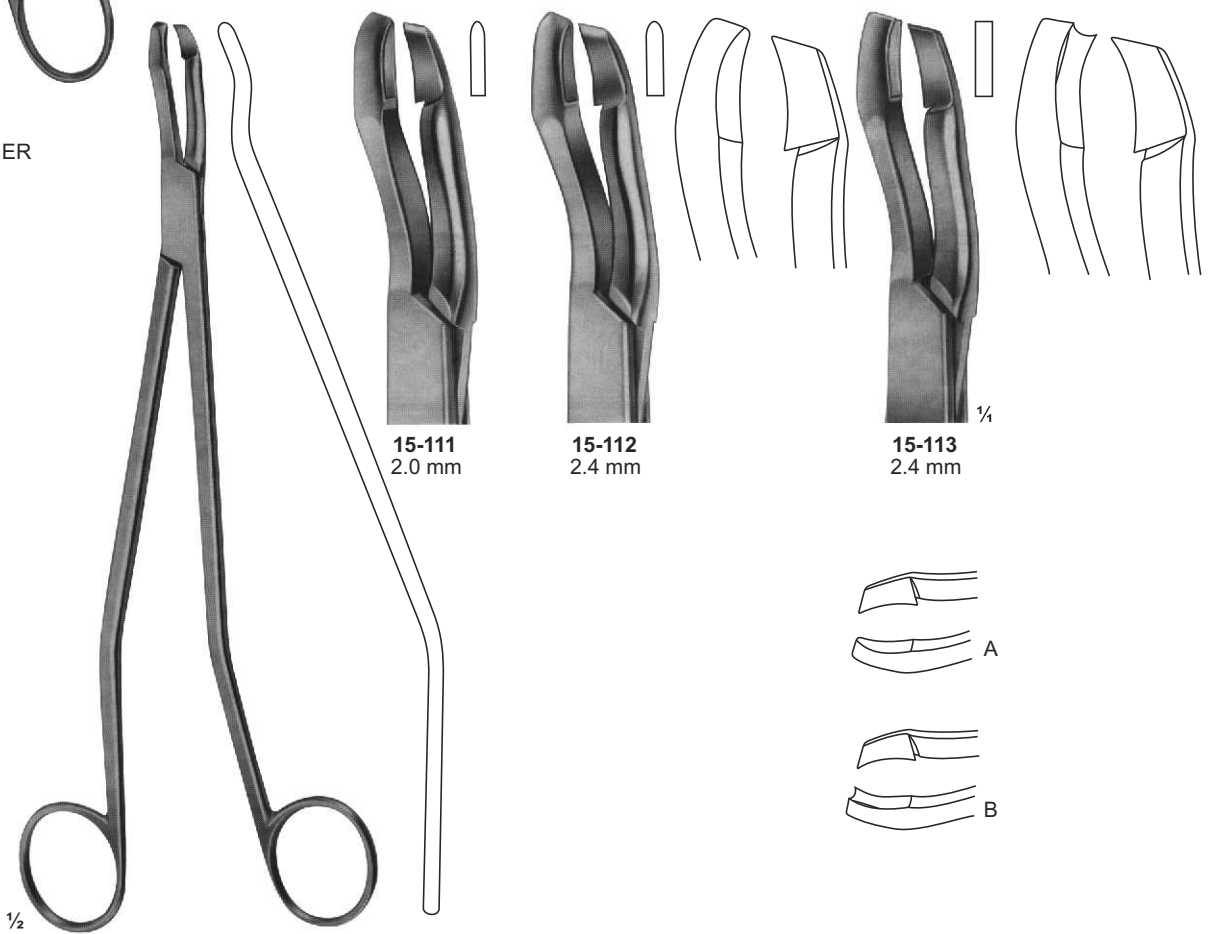
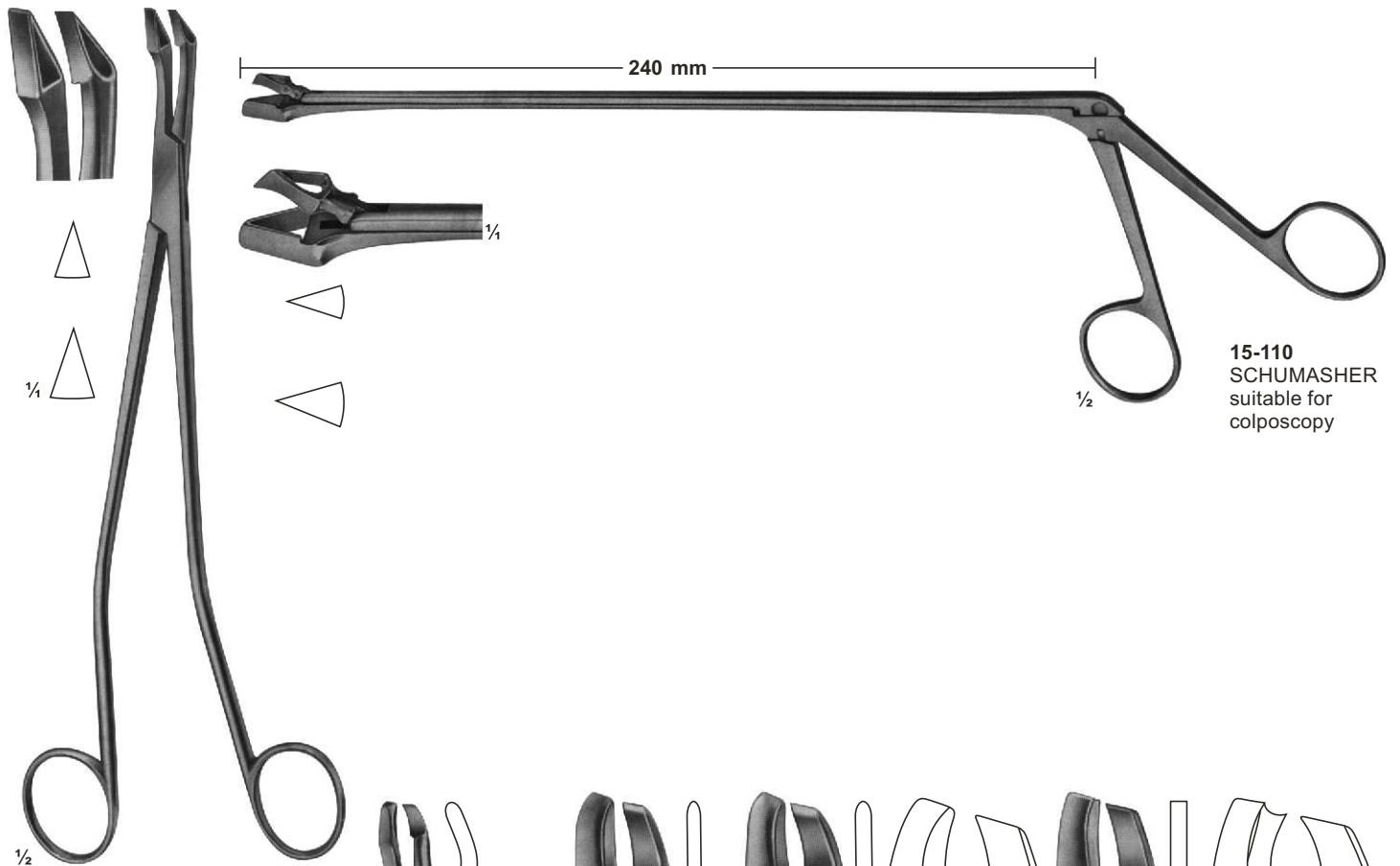

15-111 - 113
SEIDL DBP
Biopsy forceps, bayonet shaped
for portio, vagina and vulva
240mm

Biopsy Forceps

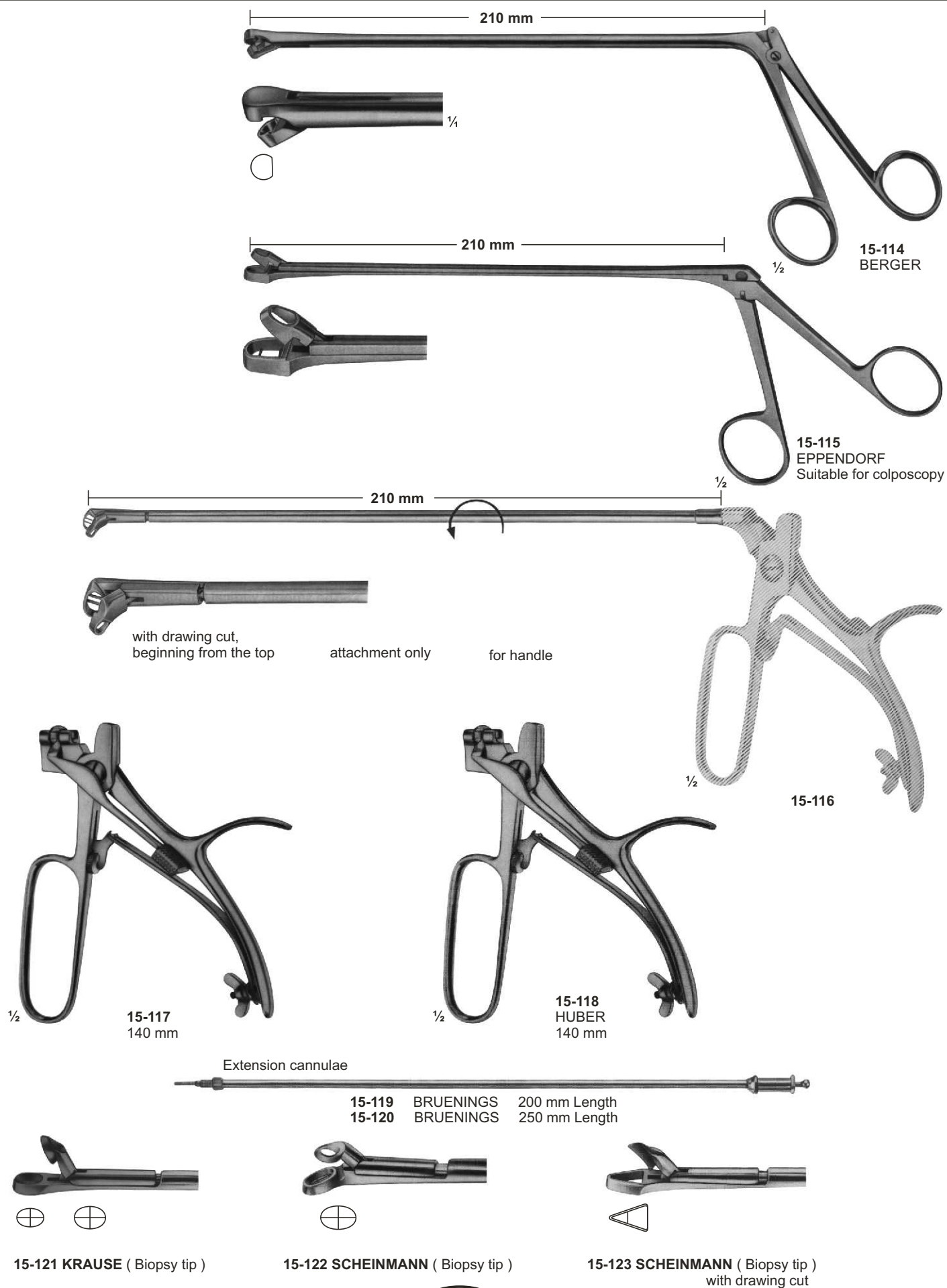

Uterine Scoops



1/2
15-124
SIMON
240 mm

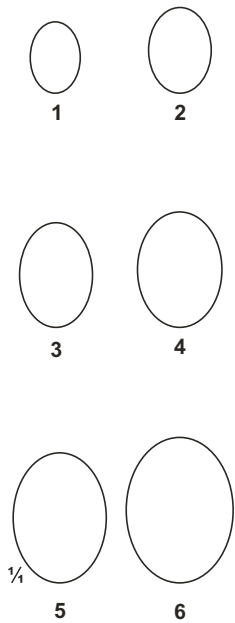

1/2
15-125
SCHRODER
310 mm

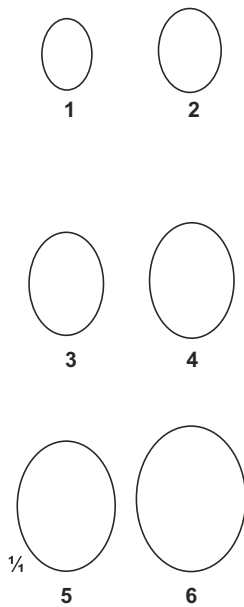

1/2
15-126
RECAMIER
300 mm

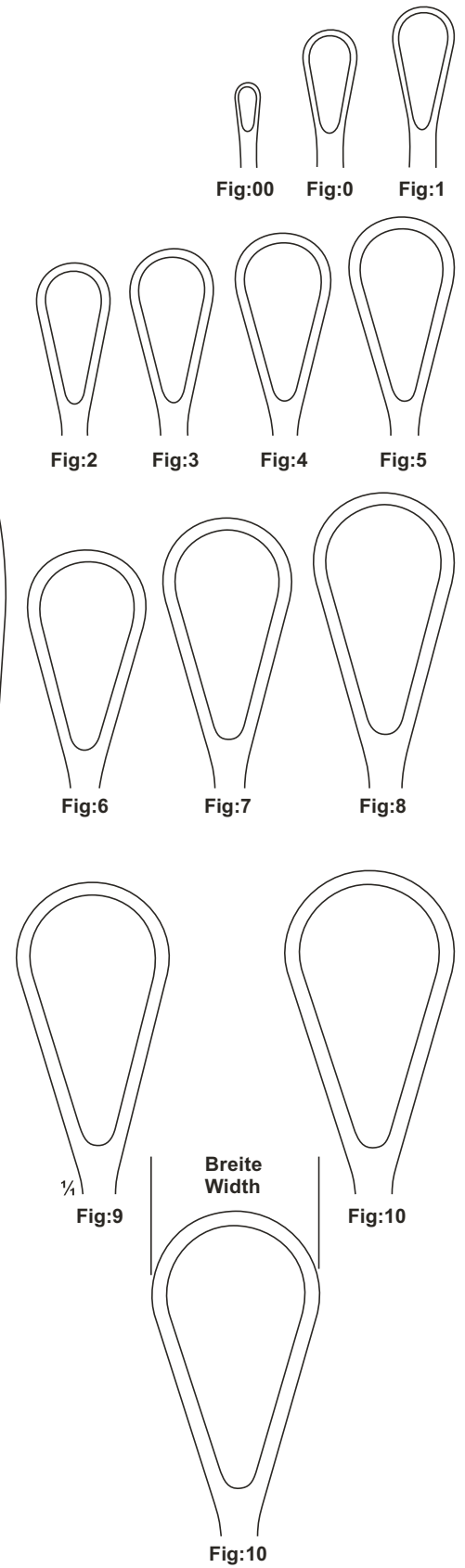

Uterine Curettes

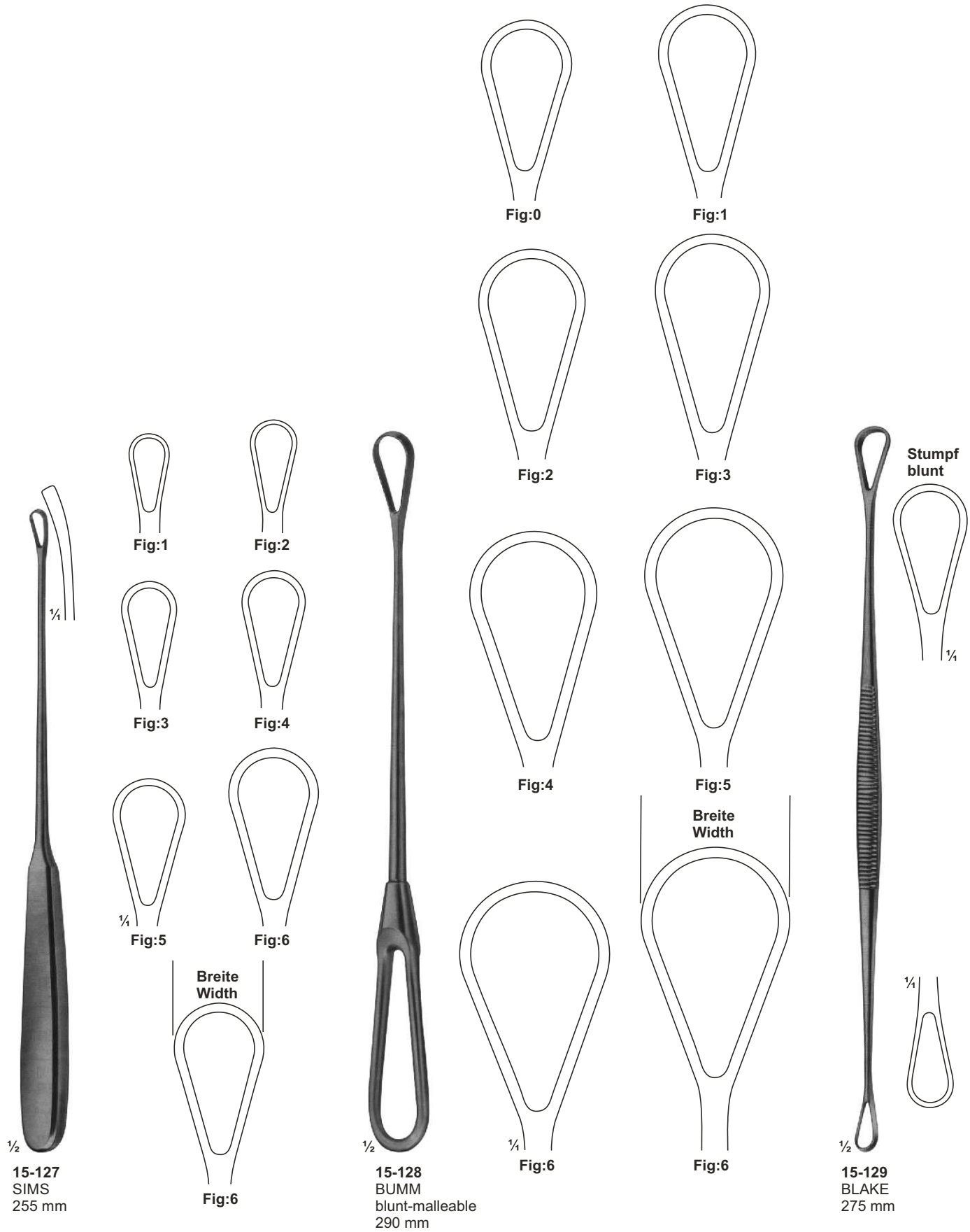

Placenta-and Ovum Curettes



15-130
COLLIN
300 mm



15-131
RECAMIER
blunt-rigid
360 mm

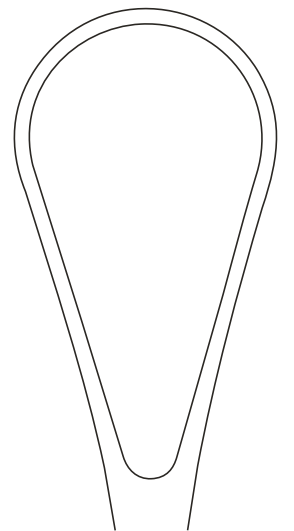

Fig:1

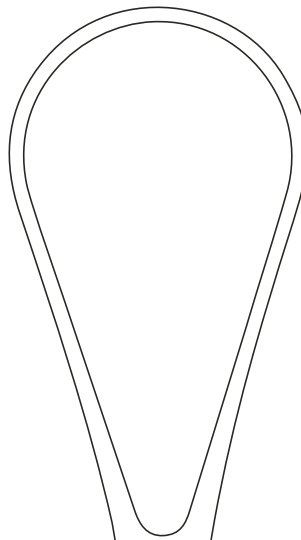

Fig:2



15-132
BUMM
310 mm

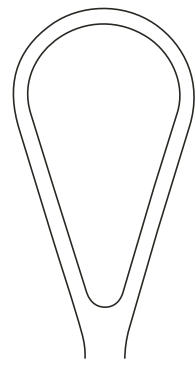

Fig:1

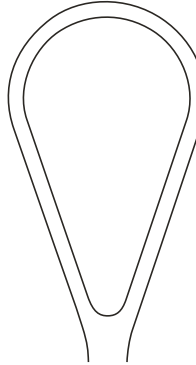

Fig:2

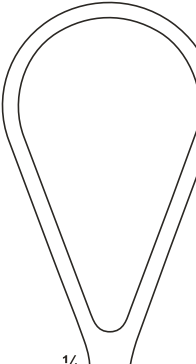

Fig:3

Vacuum Curettes

15-133 - 138

Suction curettes, stainless steel, fitting hose connection.

Working tips are smoothly rounded of, therefore no danger of perforation.

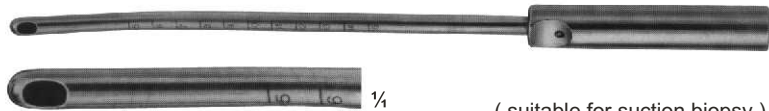

(suitable for suction biopsy)

15-133: diam 4 mm

15-134: diam 6 mm

15-135: diam 8 mm

15-136: diam 10 mm

15-137: diam 12 mm

15-138: diam 14 mm

15-139

Hose connection inside diam. 11 mm curved stainless steel.



15-140

The new connection between suction curette and hose connection, Guarantees quick changing and free turning of the suction curettes on the hose connection.

15-141

Transparent suction hose 1.8 m long, inside diam 11 mm, outside diam 16.5 mm can be sterilized in an autoclave at 1 bar overpressure (120 C)



15-142

Strainer for tissues, plastic, for single use only, to be used for histopathological examination.

Gynaecological Instruments

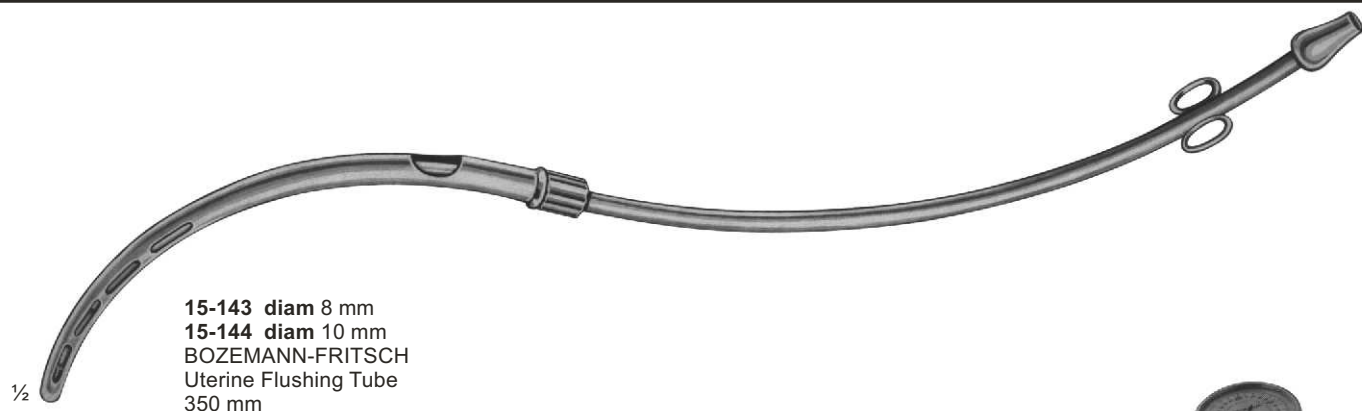

15-143 diam 8 mm
15-144 diam 10 mm
BOZEMANN-FRITSCH
Uterine Flushing Tube
350 mm

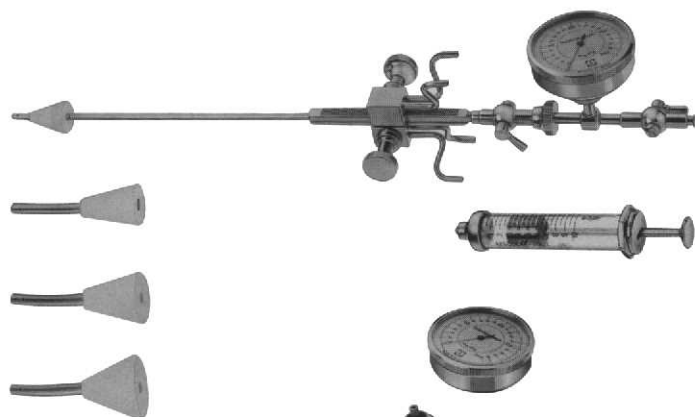

15-145
SCHULZE
Salpingograph, for utero-salpingography
in wooden case, consisting of:
Manometer, Connection, Uterine canulla
with tap, Cone S.M.L.,
Record Syringe 10 cc, Luer lock mount.



15-146
SCHULZE
Salpingograph, equipment
without manometer.

Obstetrics-Pelvimeters

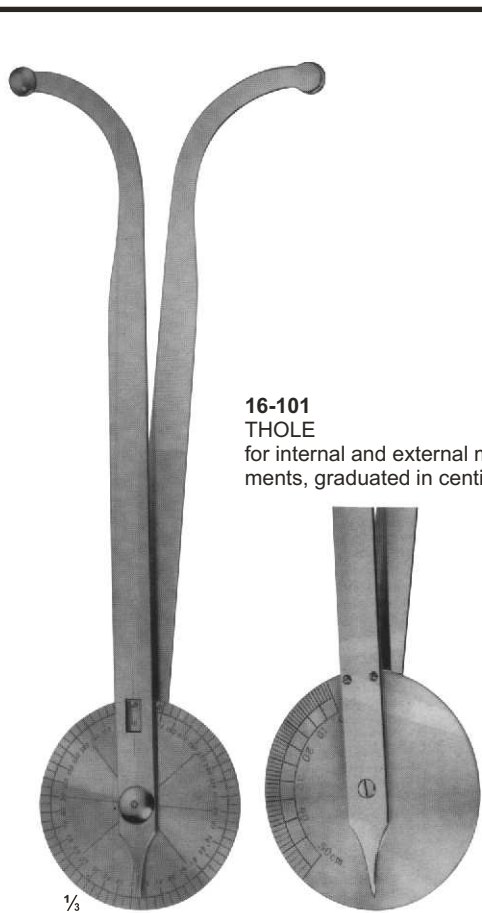

16-101
THOLE
for internal and external measurements, graduated in centimeters



16-102
DE LEE
graduated in centimeters and inches

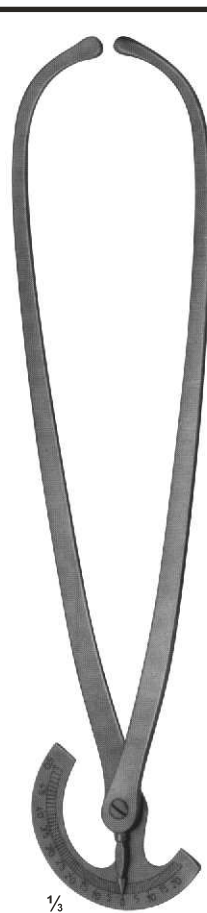

16-103
COLLIN
graduated in centimeters



16-104
MARTIN
graduated in centimeters



1/3



for internal measurements between symphysis and promontory

16-105
COLLIN
graduated in centimeters

The additional straight arm can be replaced. The pelvimeter with straight arm is used for localisation of the portio vaginalis uteri and of vaginal metastasis.



1/3

16-106
BREISKY
graduated in centimeters

Obstetrics-Pelvimeters

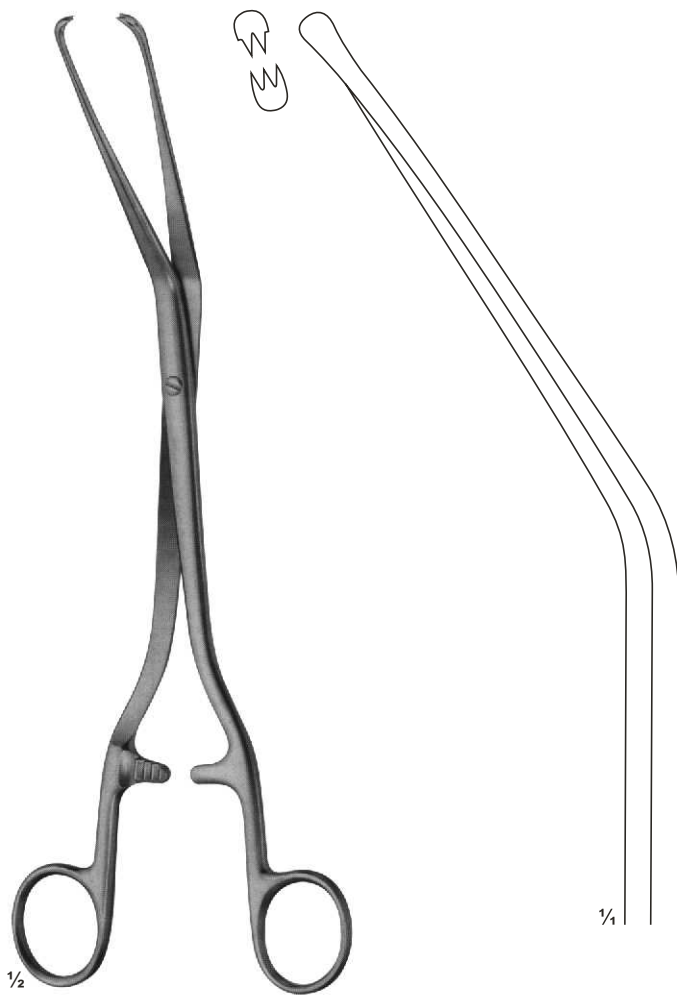

16-107
HERFF
puncturing forceps
225 mm



16-108
IOWA
puncturing forceps
260 mm

Scissors of Obstetrics, Umbilical cord clamp



16-109
SCHUMACHER
Umbilical cord
scissors
155 mm



16-110
Umbilical cord
scissors
105 mm

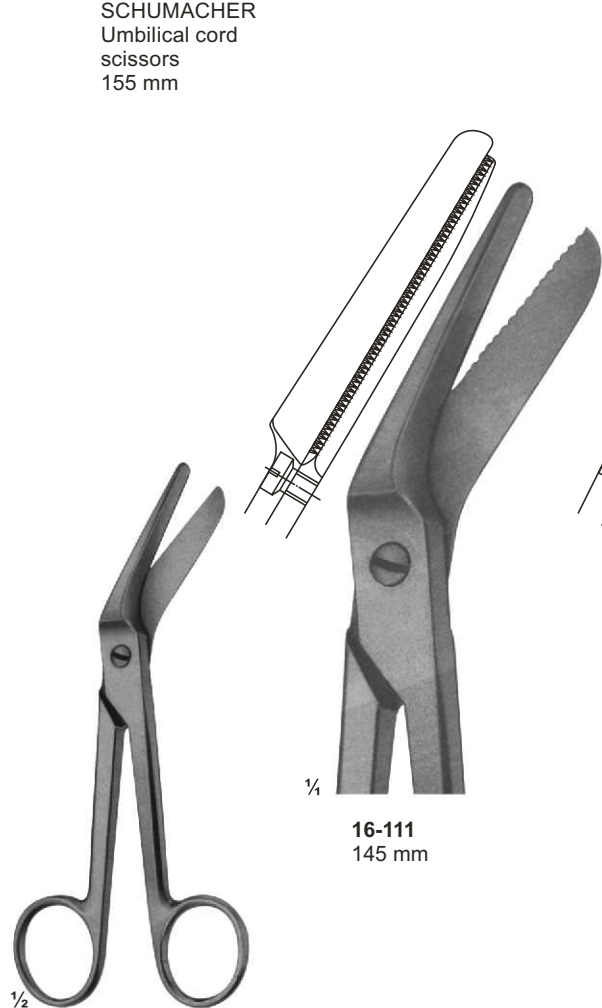

16-111 - 112
BRAUN-STADLER
Episiotomy Scissors

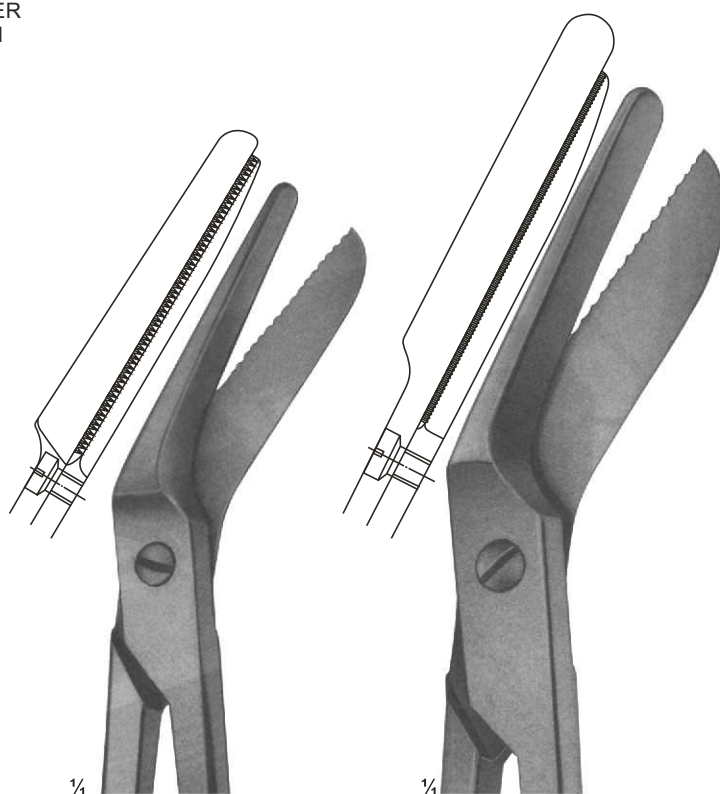

16-111
145 mm

16-112
200 mm

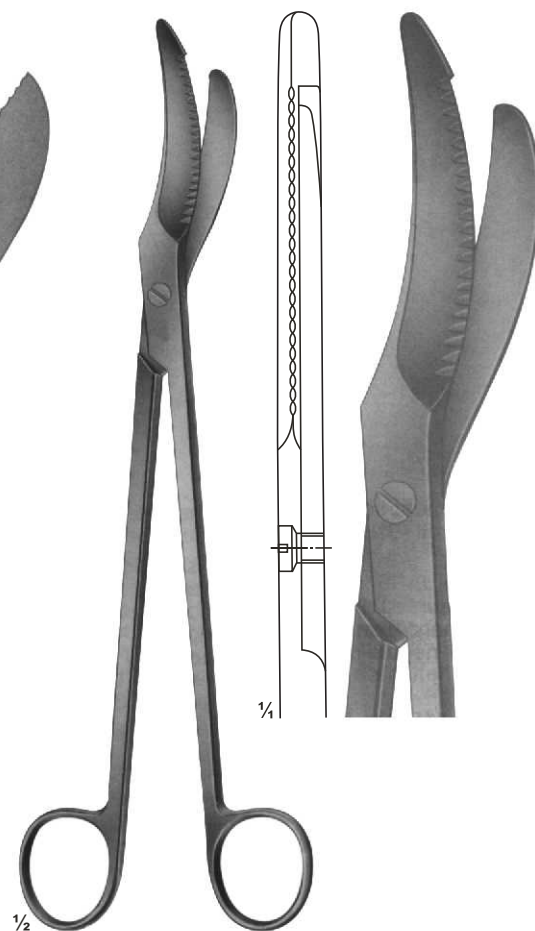

16-113
Episiotomy Scissors
240 mm

Obstetrics Forceps

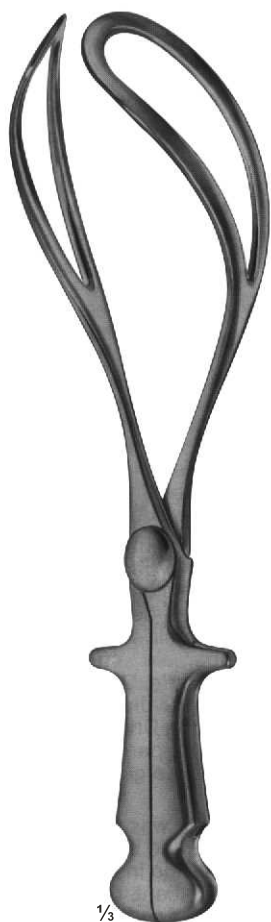

1/3

16-114
355 mm

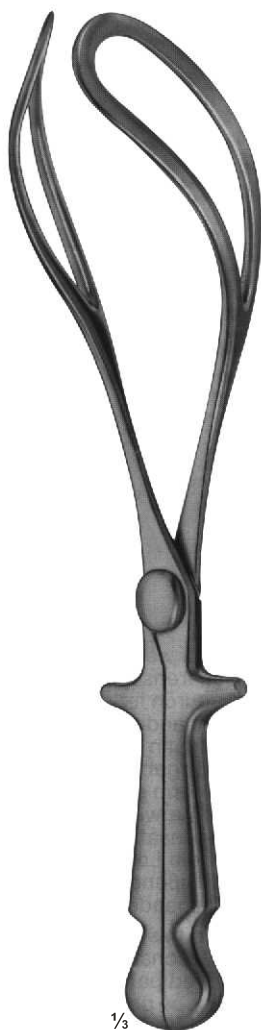

1/3

16-115
400 mm



1/3

16-116
SIMPSON-BRAUN
305mm

Obstetrics Forceps



16-117
SIMPSON-BRAUN
305mm

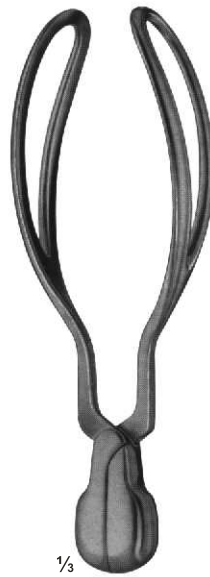

16-118
SIMPSON
235mm

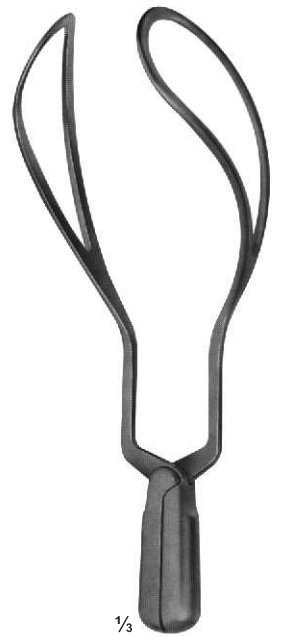

16-119
WRIGLEY
250 mm

Obstetrics Forceps

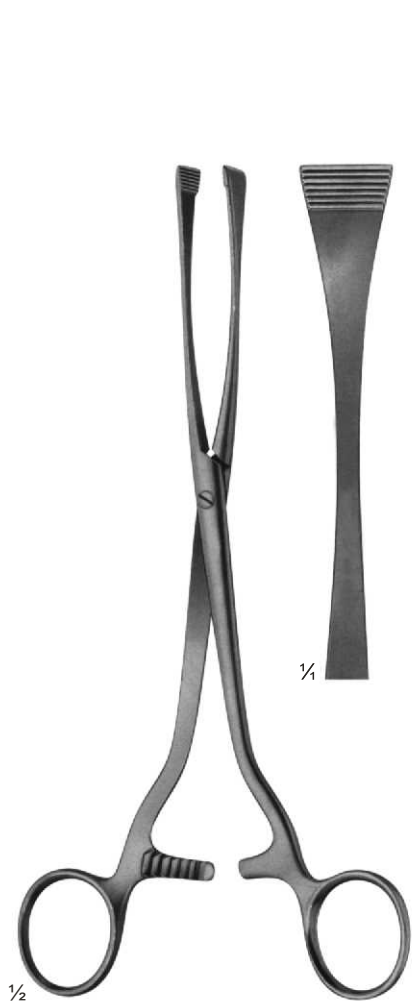

16-120
GREEN-ARMYTAGE
Caesarean section haemostatic
forceps, for edges of the transverse
incision in the lower segment
220 mm



16-121
WILLETT
Scalpel Flap forceps
185 mm



16-122
GAUSS
Scalpel Flap forceps
260 mm

Obstetrics-Placenta and Ovum Forceps

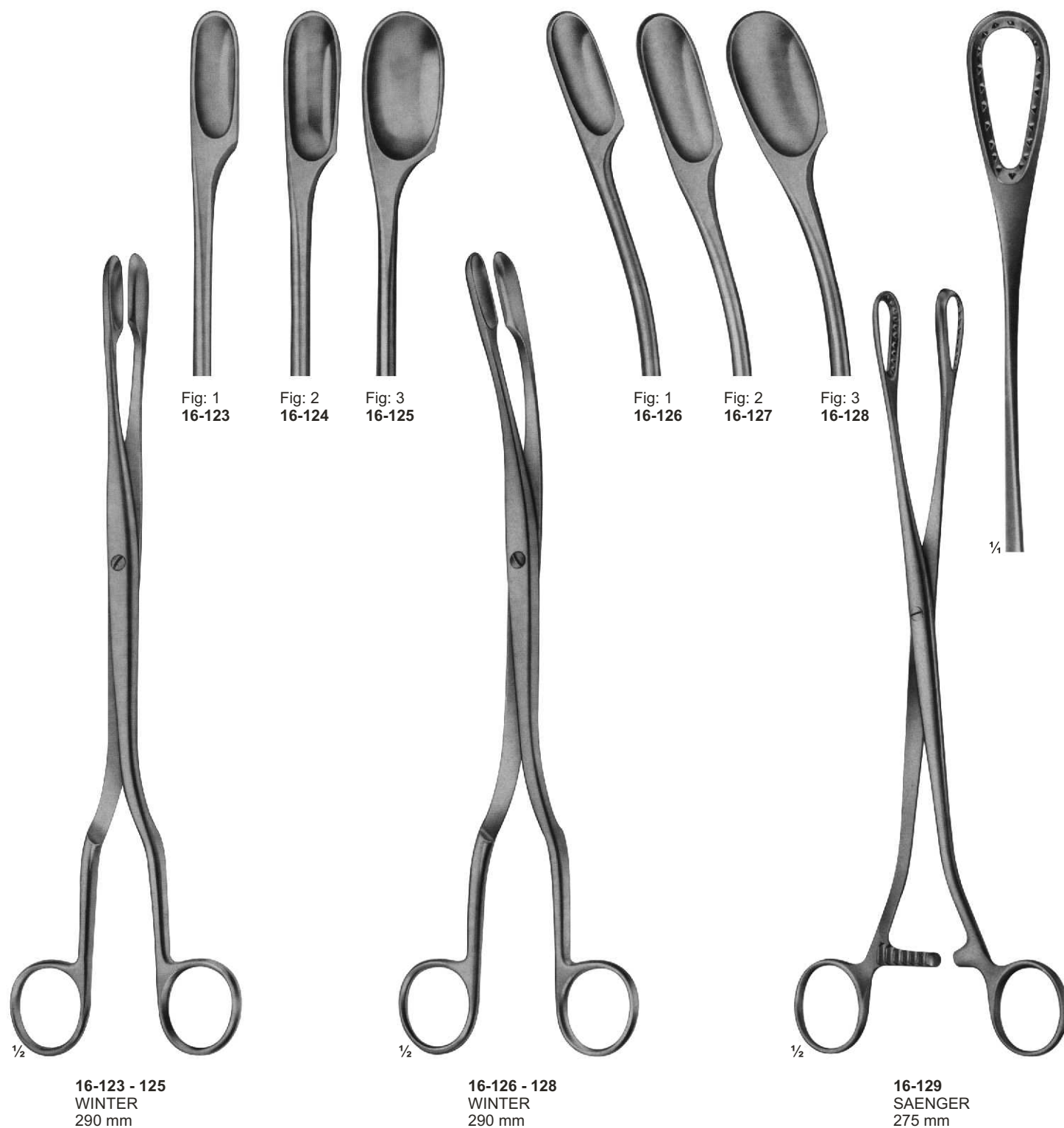

Obstetrics-Placenta and Ovum Forceps

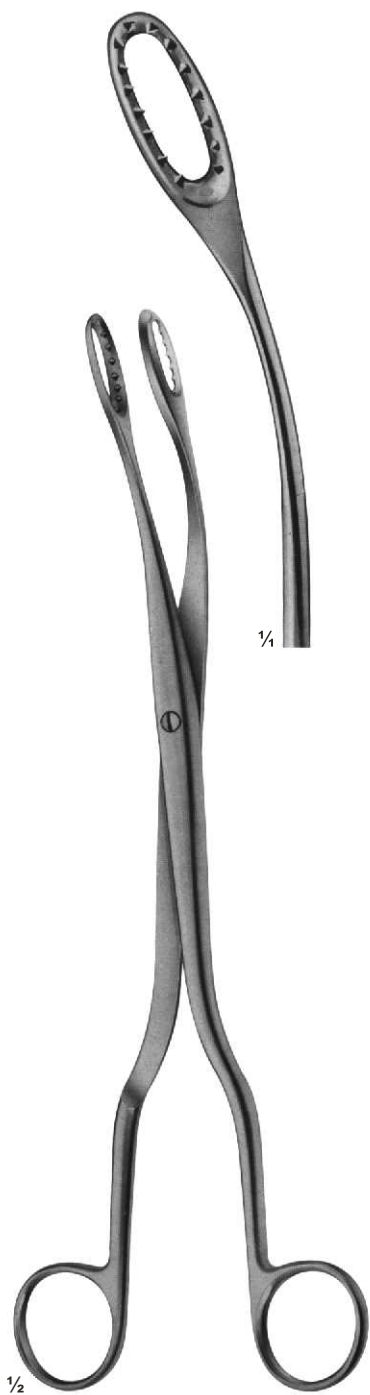

16-130
SAENGER
285 mm

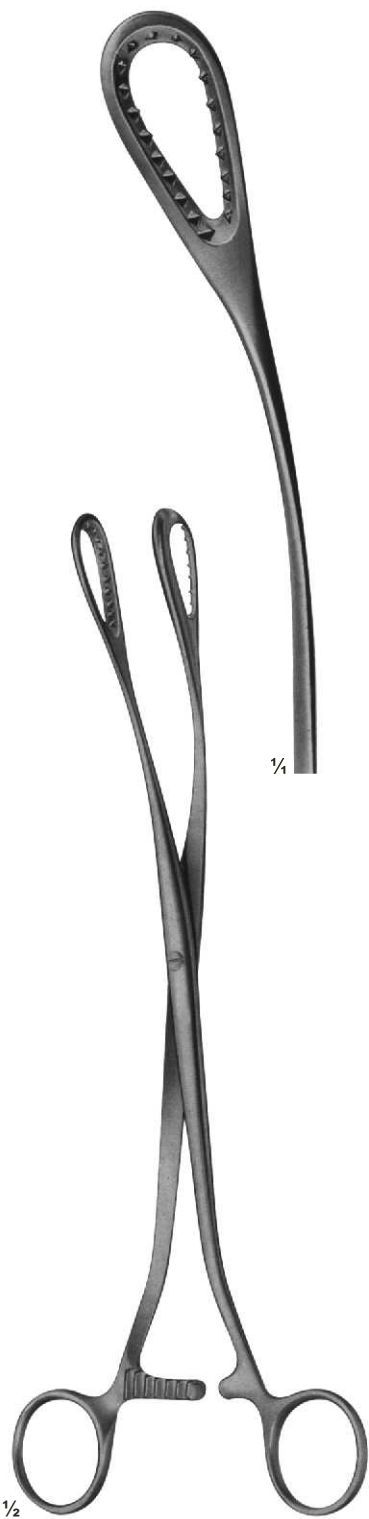

16-131
SAENGER
285 mm

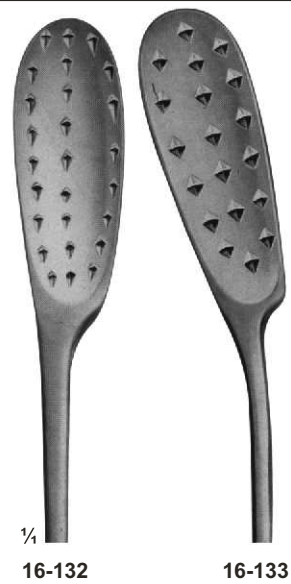

16-132

16-133

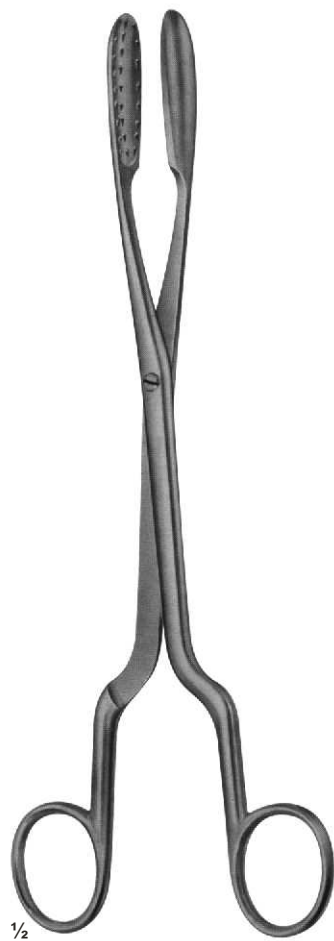

16-132 - 133
LEWKOWIZ
245 mm

Obstetrics-Placenta, Ovum and Cranioclast, Basiotribe Forceps

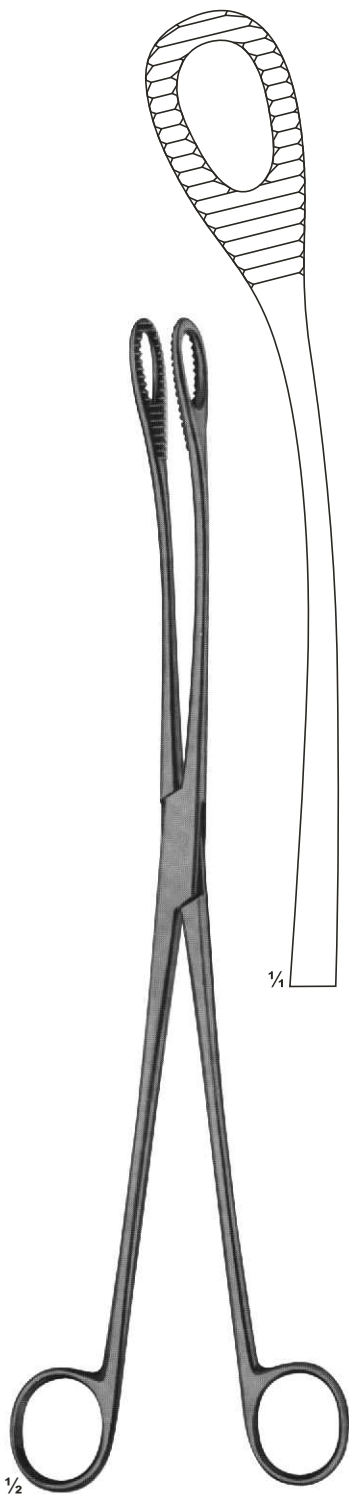

16-134
KELLY
320mm



16-135
SMELLIE
Perforator
270mm



16-136
BRAUN
Cranioclast
420mm

Tracheal Tubes with inner tubes



½

16-137
UECKERMANN-DENKER
 Cryothyrotomy trocar
 with silver cannula
 130mm

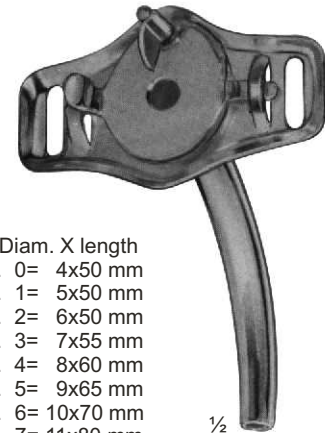

½

- Diam. X length
- 16-138** Fig. 0= 4x50 mm
 - 16-139** Fig. 1= 5x50 mm
 - 16-140** Fig. 2= 6x50 mm
 - 16-141** Fig. 3= 7x55 mm
 - 16-142** Fig. 4= 8x60 mm
 - 16-143** Fig. 5= 9x65 mm
 - 16-144** Fig. 6= 10x70 mm
 - 16-145** Fig. 7= 11x80 mm
 - 16-146** Fig. 8= 12x85 mm
 - 16-147** Fig. 9= 13x90 mm
 - 16-148** Fig. 10=14x90 mm

16-138 - 148
LUER
 German silver



½

16-149 - 158
JACKSON
 German Silver

- Diam. X length
- 16-149** Fig. 0= 4x50 mm
 - 16-150** Fig. 1= 5x58 mm
 - 16-151** Fig. 2= 6x58 mm
 - 16-152** Fig. 3= 7x70 mm
 - 16-153** Fig. 4= 8x78 mm
 - 16-154** Fig. 5= 9x84 mm
 - 16-155** Fig. 6= 10x84 mm
 - 16-156** Fig. 7= 11x86 mm
 - 16-157** Fig. 8= 12x88 mm
 - 16-158** Fig. 9= 13x90 mm



½

- Diam. X length
- 16-159** Fig. 1= 5x48 mm
 - 16-160** Fig. 2= 6x58 mm
 - 16-161** Fig. 3= 7x70 mm
 - 16-162** Fig. 4= 8x78 mm
 - 16-163** Fig. 5= 9x84 mm
 - 16-164** Fig. 6= 10x84 mm
 - 16-165** Fig. 7= 11x86 mm
 - 16-166** Fig. 8= 12x88 mm
 - 16-167** Fig. 9= 13x90 mm
 - 16-168** Fig.10= 14x90 mm

16-159 - 168
JACKSON
 German Silver

Tound-and Tracheal Hooks and Dilators



16-169
BOSE
165 mm



16-170
BOSE
165 mm

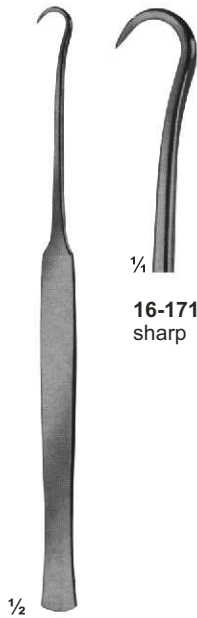

16-171 - 173
180 mm

16-171
sharp



16-172
blunt

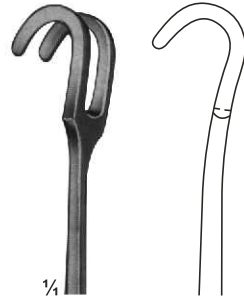

16-173
stumpf/blunt

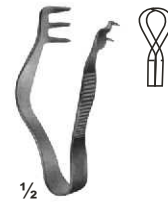

16-174
FINSEN
50 mm

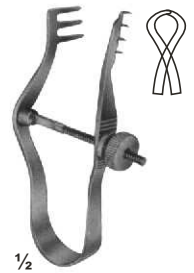

16-175
FINSEN
70 mm



16-176
TROUSSEAU
120 mm



16-177
LABORDE
125 mm

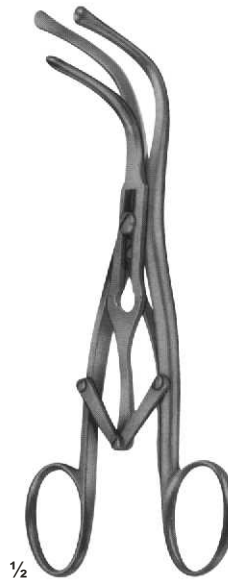

16-178
LABORDE
strong pattern
135 mm



16-179
Cleaning Brush
for tracheal tubes
285 mm

Irrigating Cannulae, Embolus Grasping Forceps, Dilators

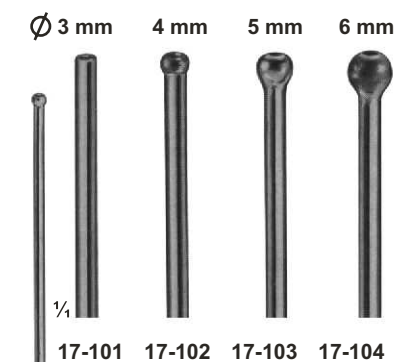

17-101 - 104
SCHMID
 Vessel irrigating cannulae,
 malleable, silver plated
 150 mm

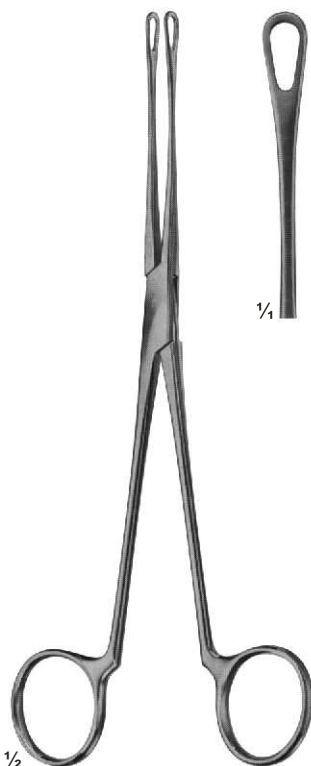

17-105
BLAKE
 Embolus grasping
 forceps
 205 mm

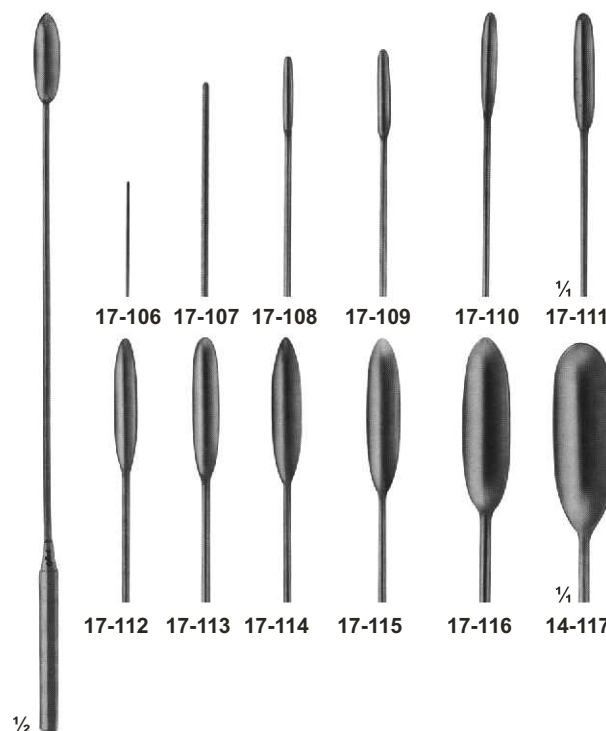

17-106 - 117
DE BAKEY
 Vascular dilators,
 malleable
 190 mm

17-106 0,5 mm Ø	17-112 3,5 mm Ø
17-107 1,0 mm Ø	17-113 4,0 mm Ø
17-108 1,5 mm Ø	17-114 4,5 mm Ø
17-109 2,0 mm Ø	17-115 5,0 mm Ø
17-110 2,5 mm Ø	17-116 7,0 mm Ø
17-111 3,0 mm Ø	17-117 9,0 mm Ø

Irrigating Cannulae, Embolus Grasping Forceps, Dilators

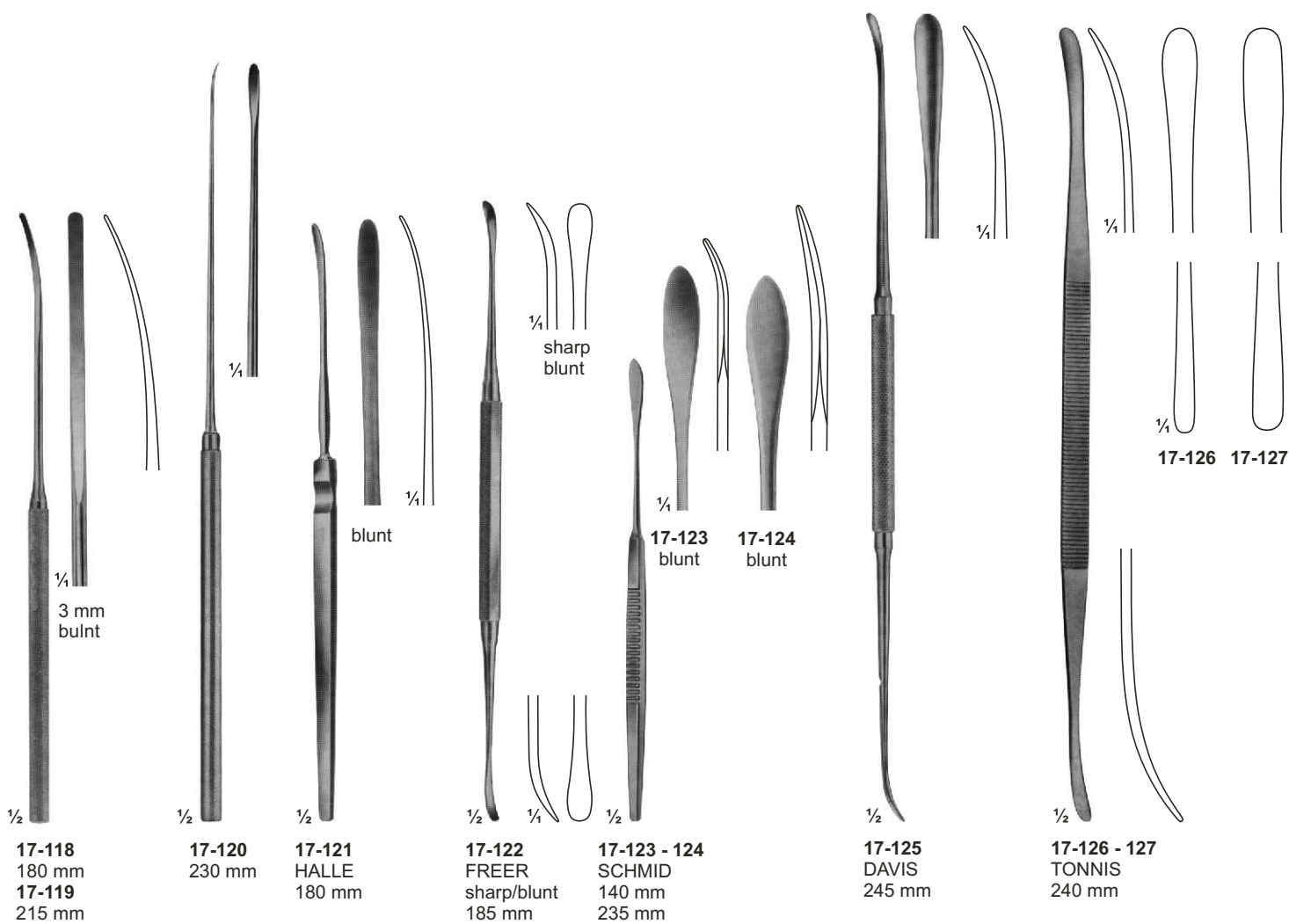

Irrigating Cannulae, Embolus Grasping Forceps, Dilators

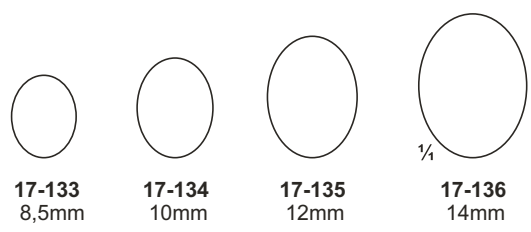
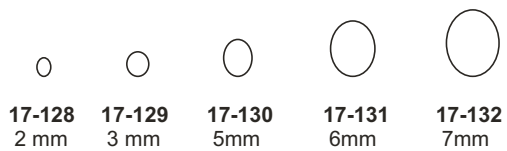

17-128 - 136
Endarterectomy strippers
550 mm



17-137
Handle for
110 mm

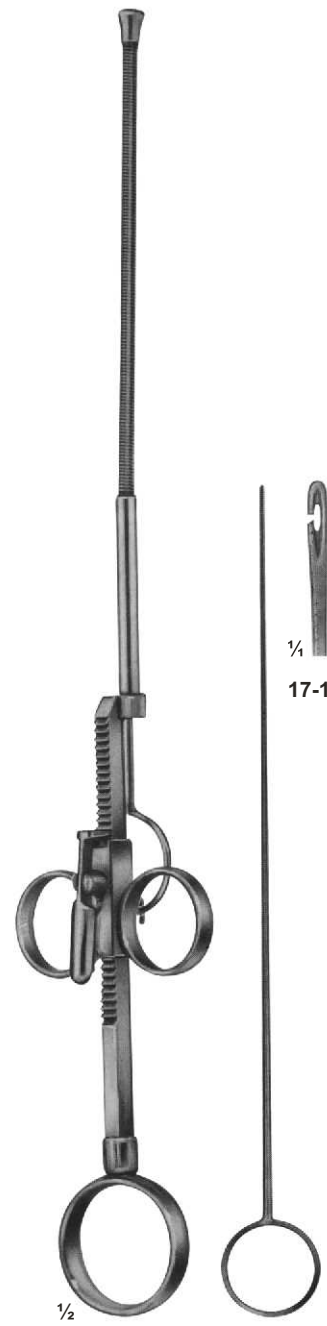

17-138 - 139
RUMEL-BELBONT
325 mm
17-138 - 4,0 mm Ø
17-139 - 6,4 mm Ø

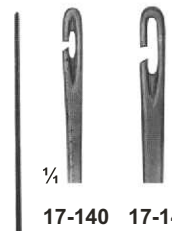

17-140 17-141



17-140 - 141
Guide only

Biopotome and Aortic Dilators

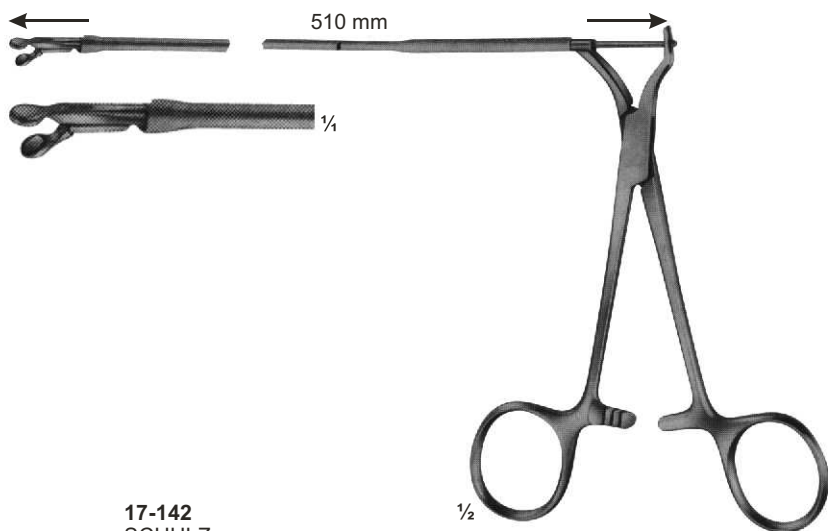

**17-142
SCHULZ**
Biopptome, mit flexiblem Schaft, 510 mm lang,
with round jaws 3 mm diam.

Biopsy forceps, for biopsy from the right atrium
through cava juglaris, prior to heart implantations.

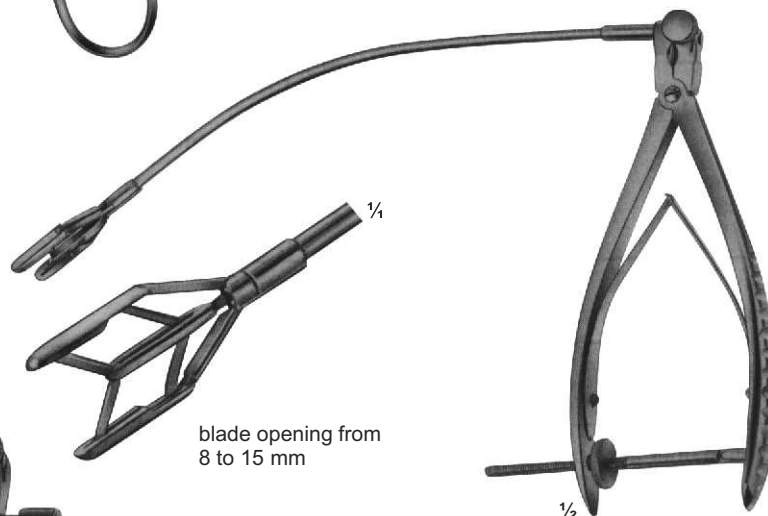

**17-144
COOLEY**
Dilator for
mitral valve
for children

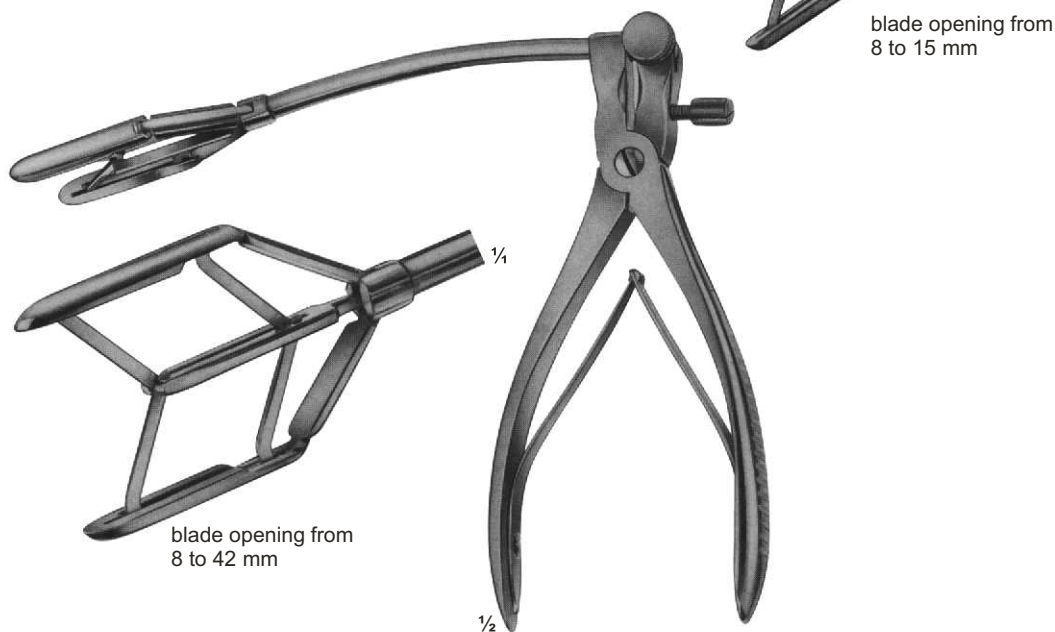

**17-143
TUBBS**
Dilator for
mitral valve

Biopotome and Aortic Dilators

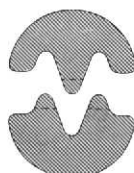
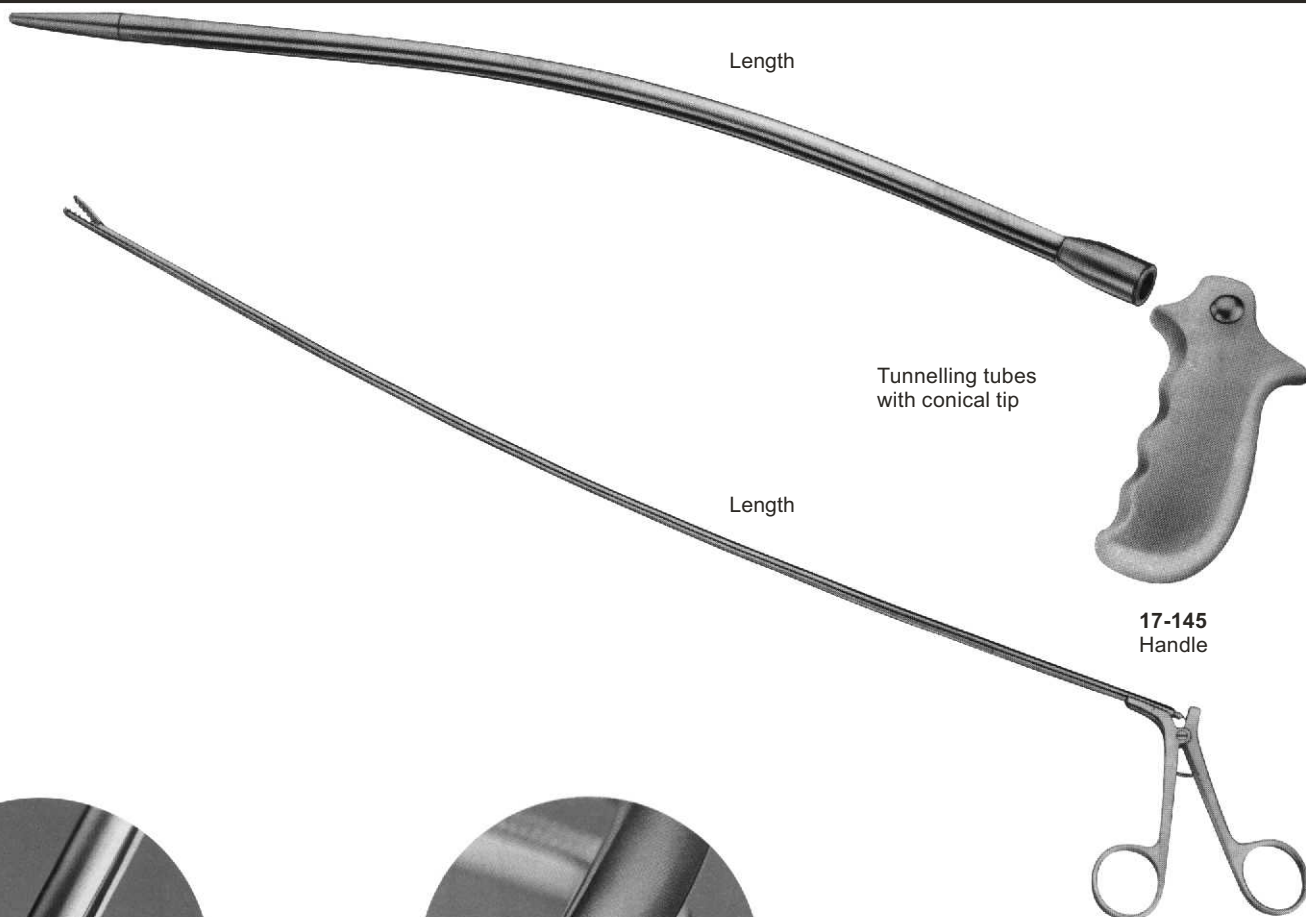

DE BAKEY
17-147
1 : 2 rows of teeth

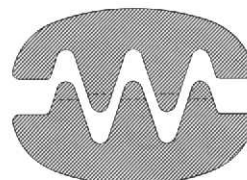
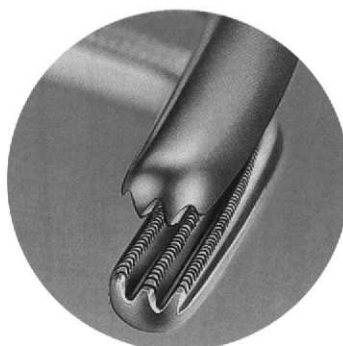

DE BAKEY
17-148
2 : 3 rows of teeth

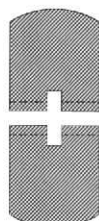
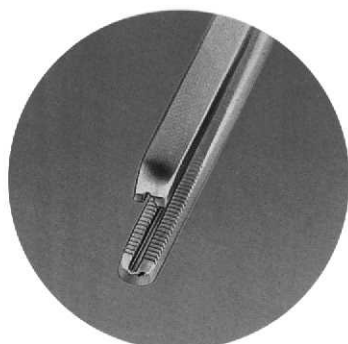

COOLEY
17-149
2 : 2 rows of teeth

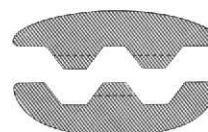
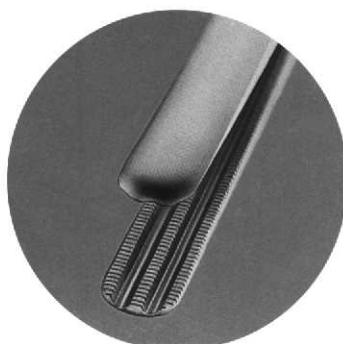

DARDIK
17-150
2 : 3 rows of teeth

Ultra-Light-Forceps

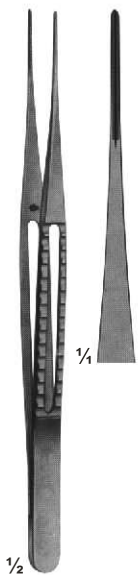

17-151
Width of jaws
1,5 mm
Length
150mm

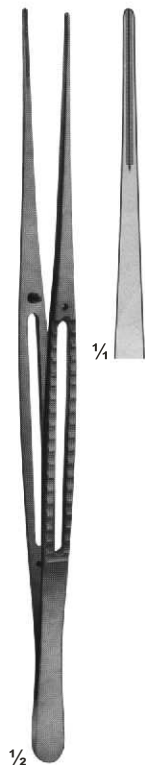

17-152
1,5 mm
200 mm



17-153
1,5 mm
240 mm



17-154
1,5 mm
300 mm

Ultra-Light-Forceps

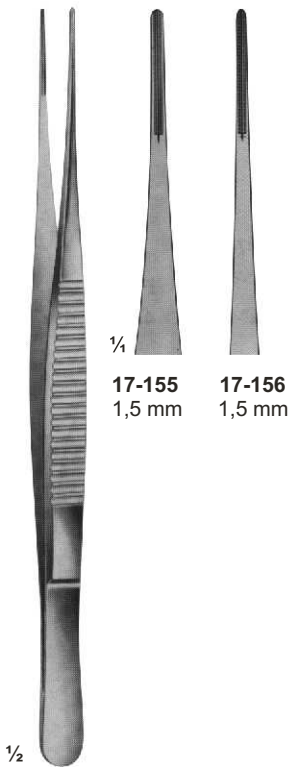

17-155
1,5 mm

17-156
1,5 mm

17-155 - 156
DE BAKEY
150 mm
300 mm

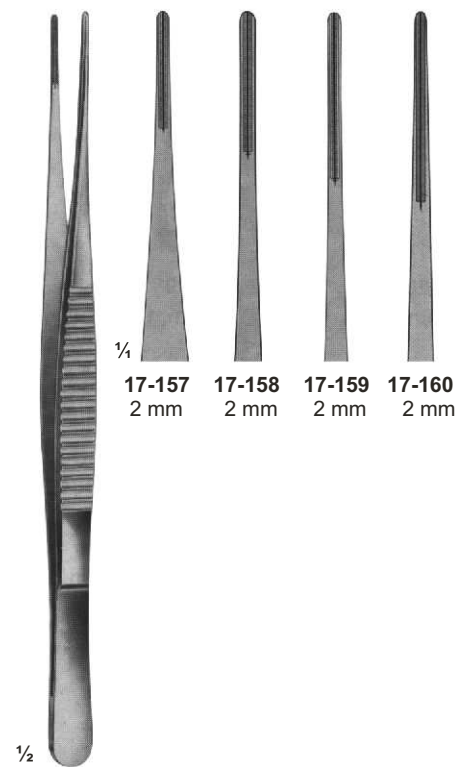

17-157
2 mm

17-158
2 mm

17-159
2 mm

17-160
2 mm

17-157 - 160
DE BAKEY
150 mm 200 mm
300 mm 240 mm

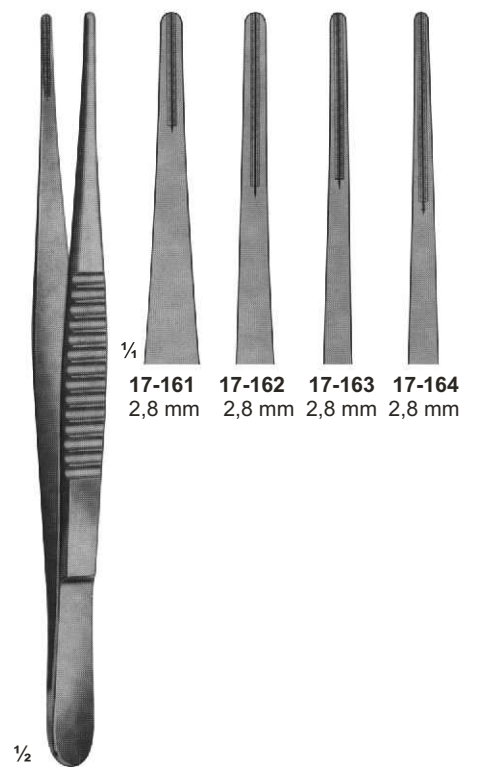

17-161
2,8 mm

17-162
2,8 mm

17-163
2,8 mm

17-164
2,8 mm

17-161 - 164
DE BAKEY
150 mm 200 mm
300 mm 240 mm

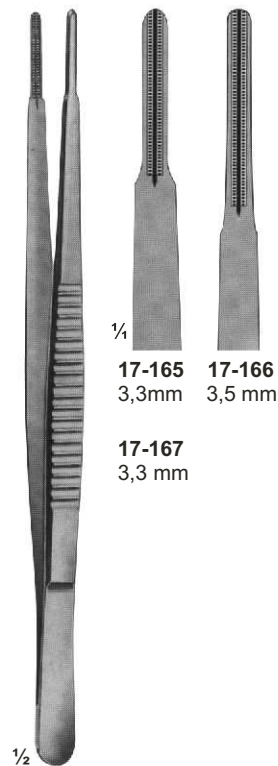

17-165
3,3mm

17-166
3,5 mm

17-167
3,3 mm

17-165 - 167
DE BAKEY
200 mm
300 mm 240 mm

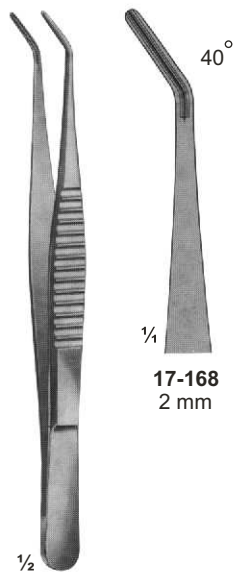

17-168
2 mm

17-168
DE BAKEY
150 mm

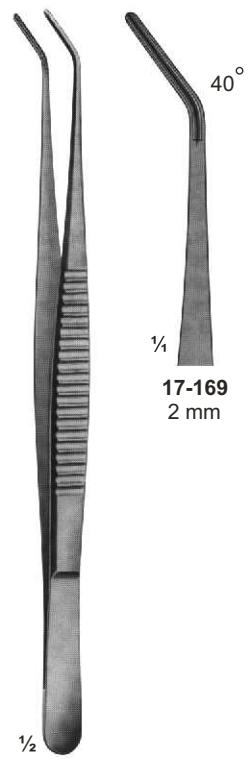

17-169
2 mm

17-169
DE BAKEY
200 mm

Ring Handle Bulldog Clamps

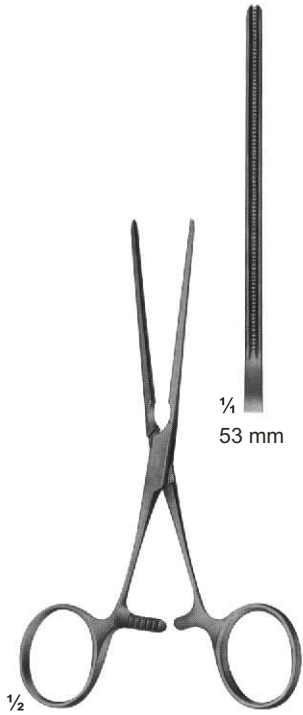

17-170
DE-BAKEY
gerade straight
130 mm

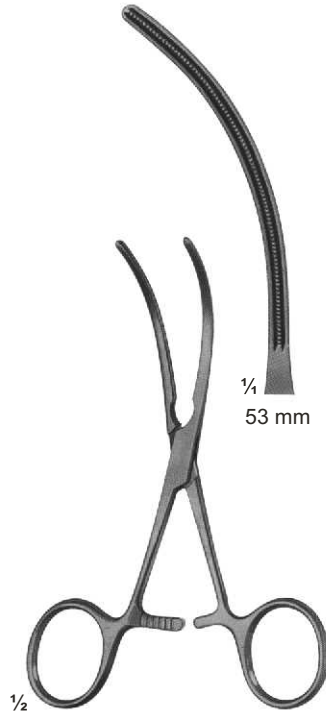

17-171
DE-BAKEY
Maul gebogen
curved jaws
125 mm

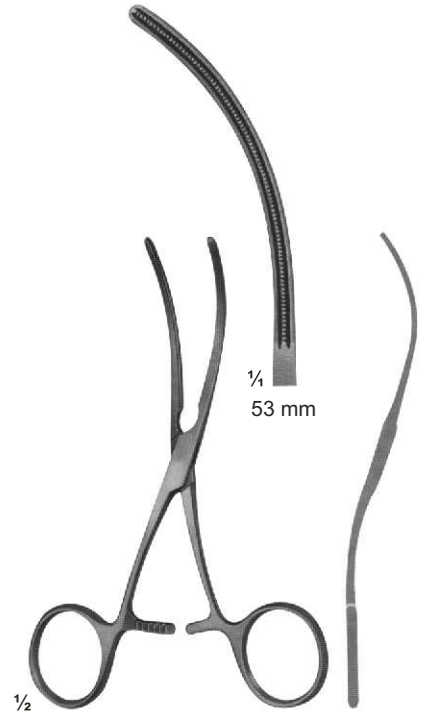

17-172
DE-BAKEY
S-shaped curved
125 mm

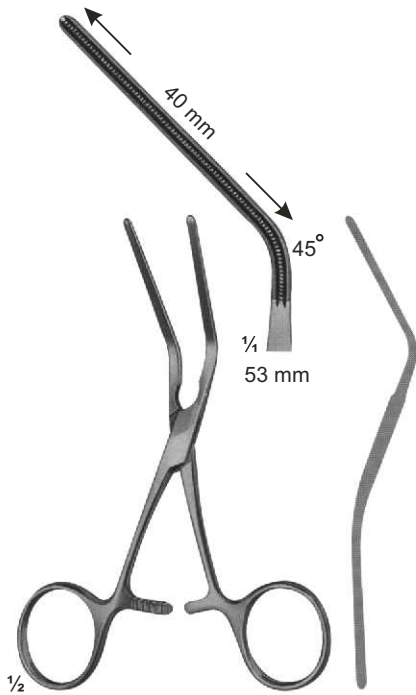

17-173
DE-BAKEY
45° winklig gebogen
angled 45°
125 mm

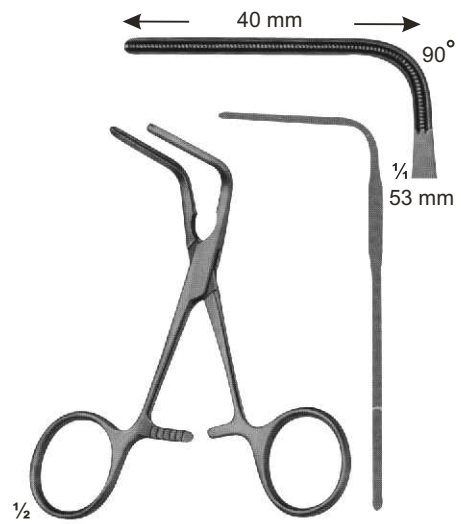

17-174
DE-BAKEY
90° winklig gebogen
angled 90°
105 mm

Anastomosis-and Multi-Purpose-Clamps for Neonatales

graduated



1/2

17-175 - 178
CASTANESA

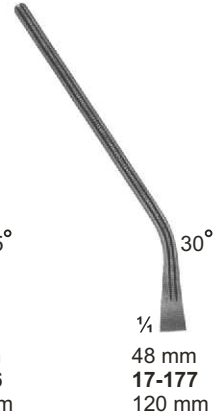
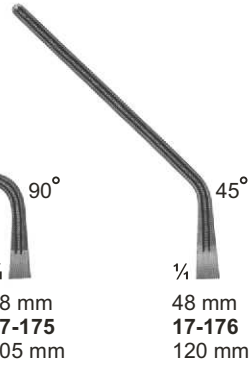
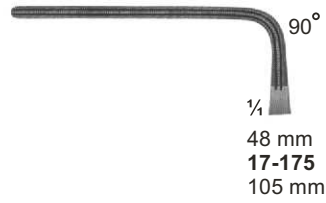

graduated



1/2

17-179 - 182
CASTANESA

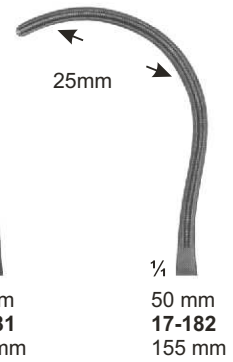
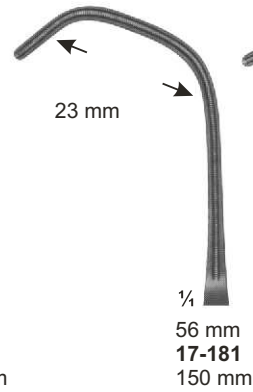
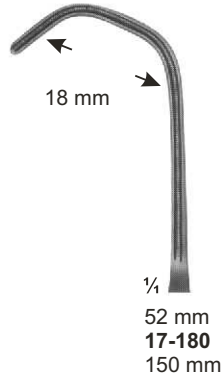
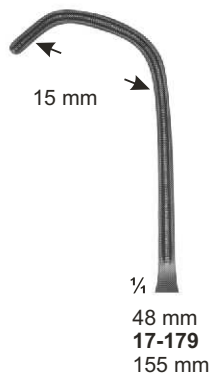

Anastomosis-and Multi-Purpose-Clamps-Pediatric types

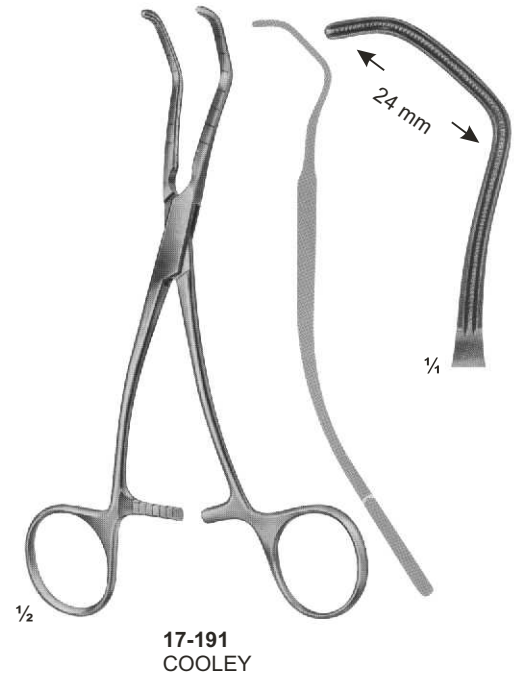
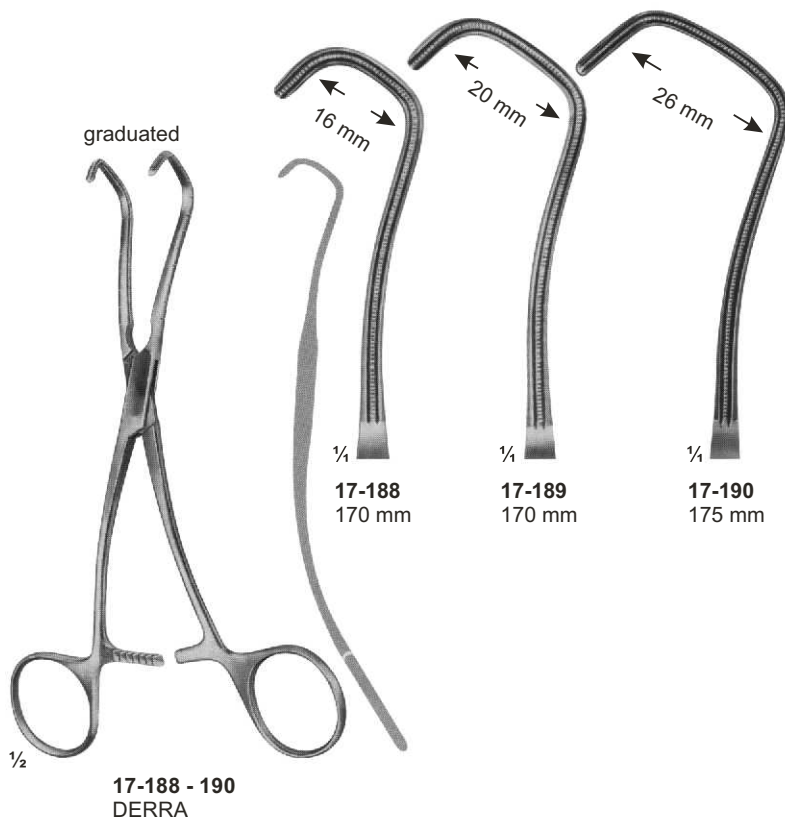
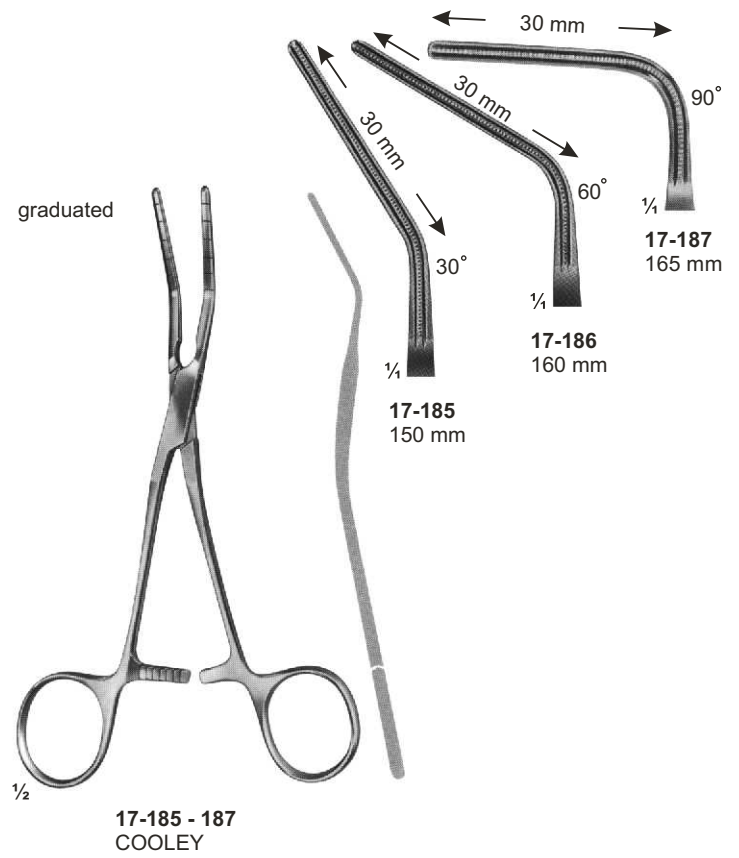
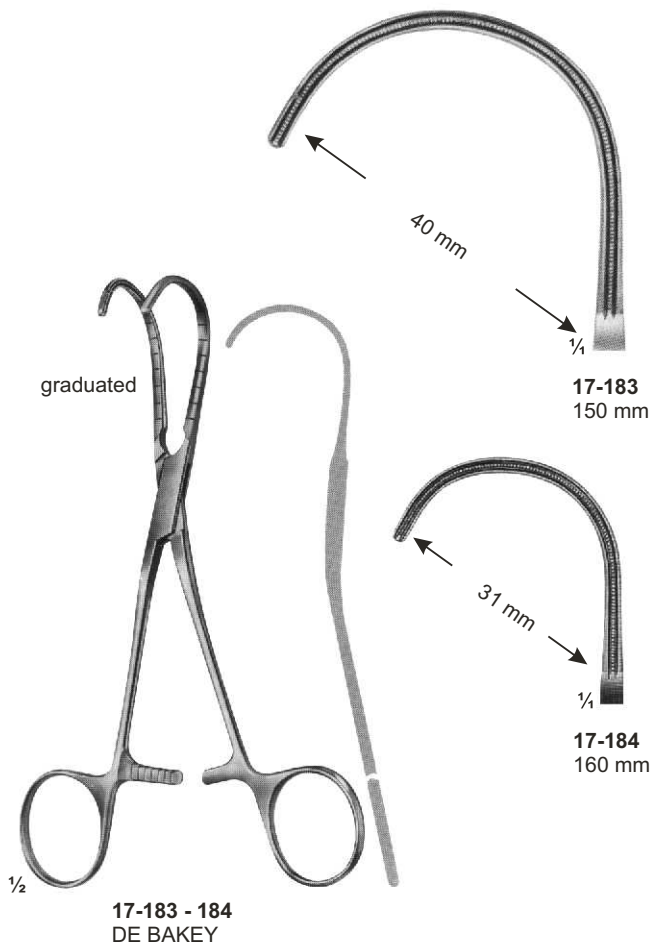

Non-traumatic Haemostatic Forceps

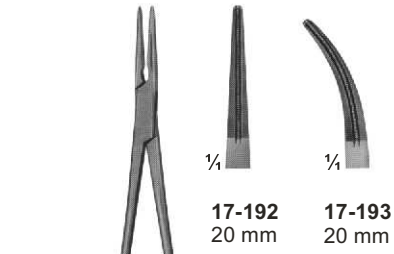

1/2
17-192 - 193
 125 mm

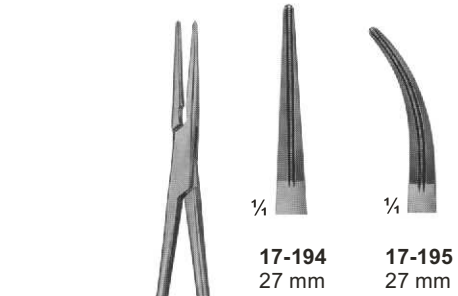

1/2
17-194 - 195
 165 mm

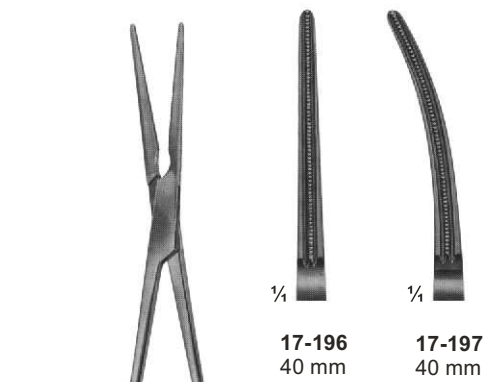

1/2
17-196 - 197
 DE BAKEY-BAINRIDGE
 155 mm

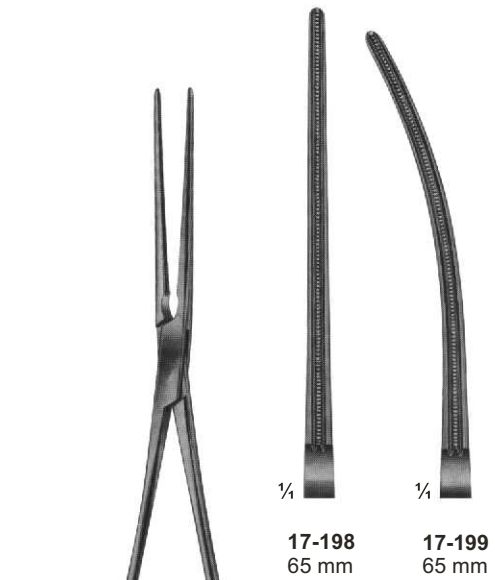

1/2
17-198 - 199
 DE BAKEY-BAINRIDGE
 180 mm

Non-traumatic Haemostatic Forceps

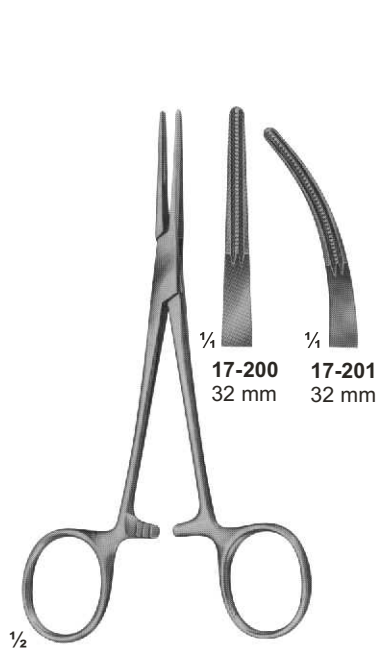

17-200 - 201
DE-BAKEY-KELLY
140 mm

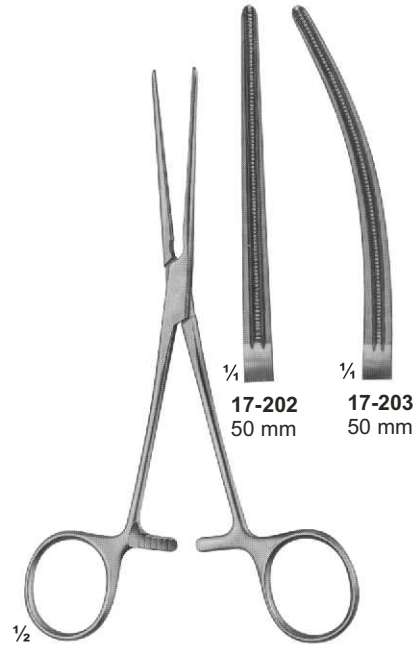

17-202 - 203
PEAN
155 mm

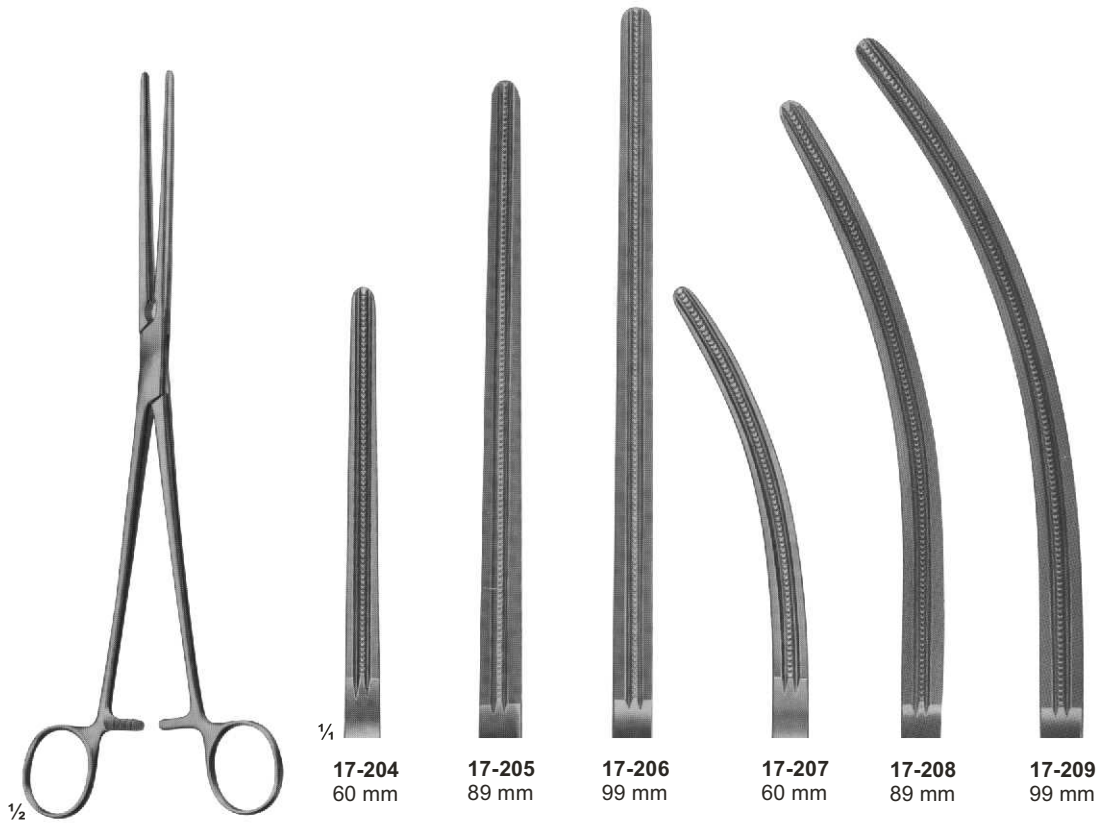

17-204 - 209
DE-BAKEY-PEAN DE-BAKEY-PEAN
17-204 200 mm **17-207** 200 mm
17-205 265 mm **17-208** 260 mm
17-206 280 mm **17-209** 275 mm

Anastomosis Clamps

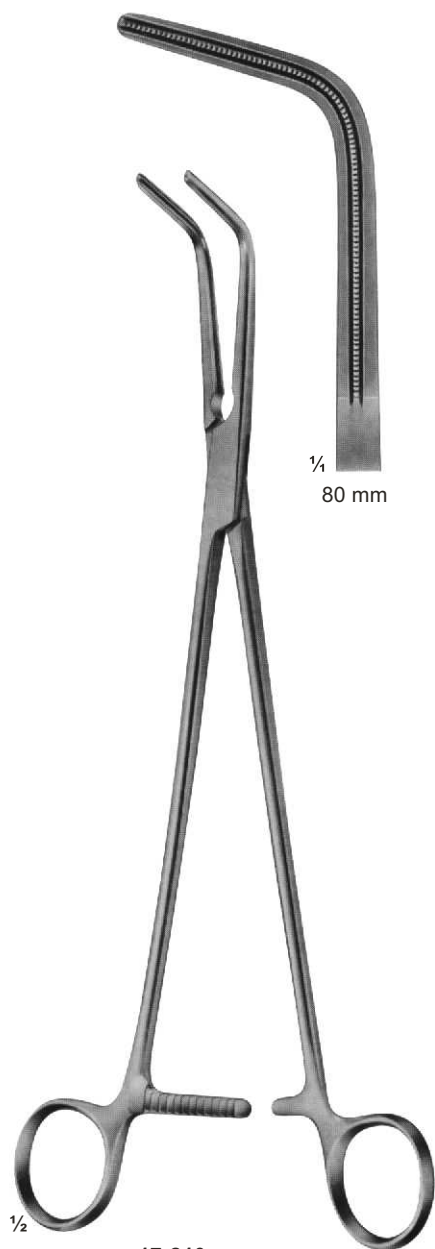

17-210
DE-BAKEY-MIXTER
285 mm

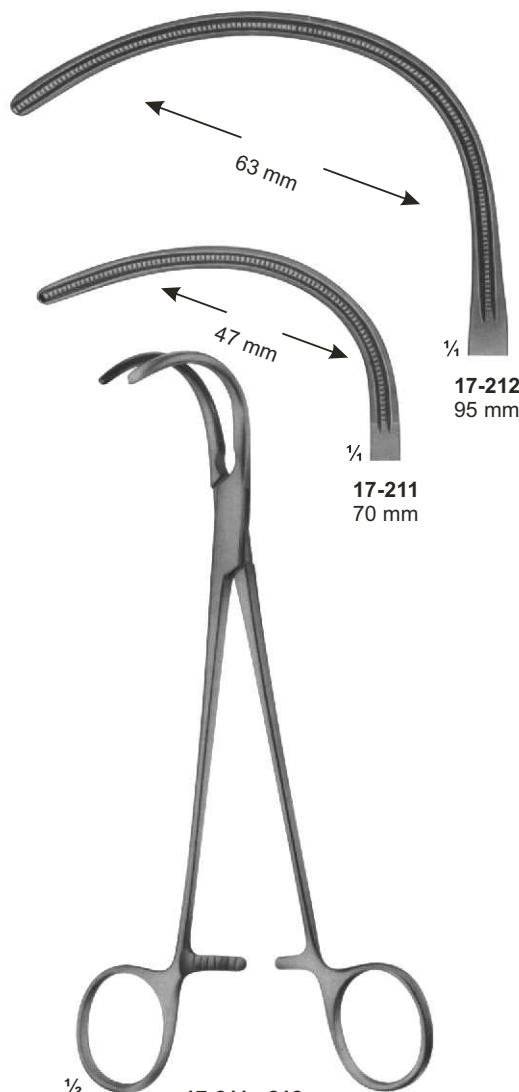

17-211 - 212
GLOVER
245 mm



17-213
GLOVER
220 mm

Vena-Cava Clamps

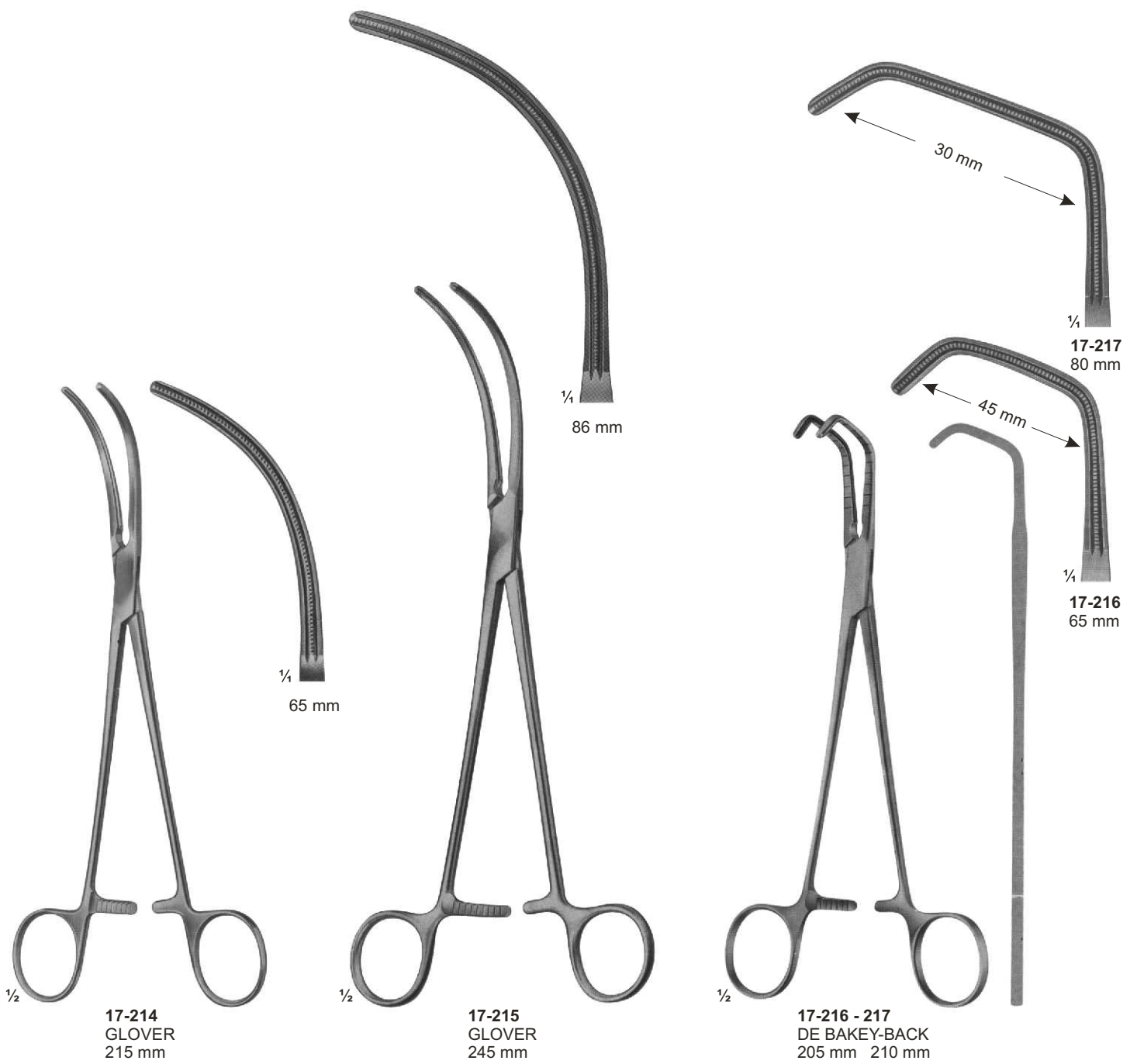

Vena-Cava Clamps



1/2



1/4
17-218
86 mm



1/4
17-219
86 mm



1/4
17-220
86 mm



1/4
17-221
86 mm

17-218 - 221
DE BAKEY-HARKEN
17-218 - 255 mm
17-219 - 245 mm
17-220 - 245 mm
17-221 - 245 mm



1/2

17-222 - 226
DE BAKEY

Total Length: 220 mm
Length of jaws: 85 mm



1/4
17-222

36 mm

256 mm
95 mm

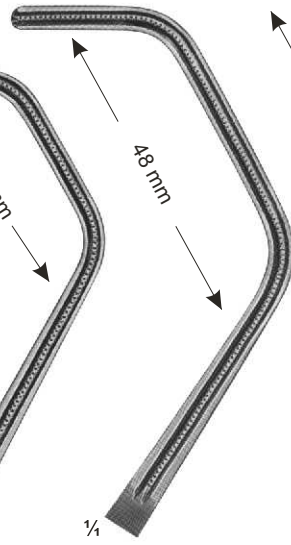

1/4
17-223

48 mm

270 mm
99 mm

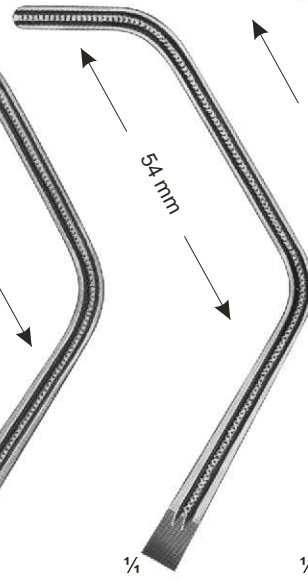

1/4
17-224

54 mm

270 mm
103 mm

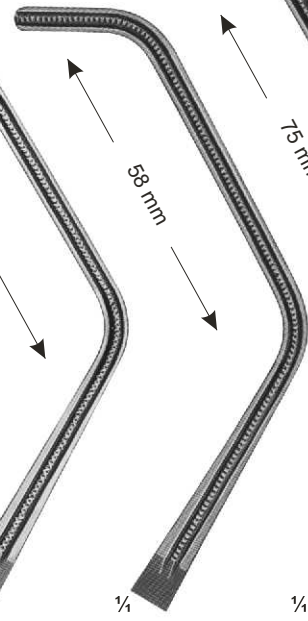

1/4
17-225

58 mm

280 mm
119 mm

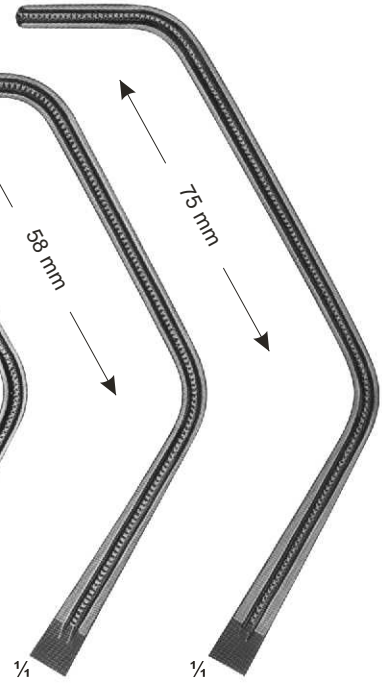

75 mm

1/4
17-226

Vena-Cava Clamps



1/2

17-227 - 229
DE BAKEY-SATINSKY
235 mm, 240 mm, 245 mm

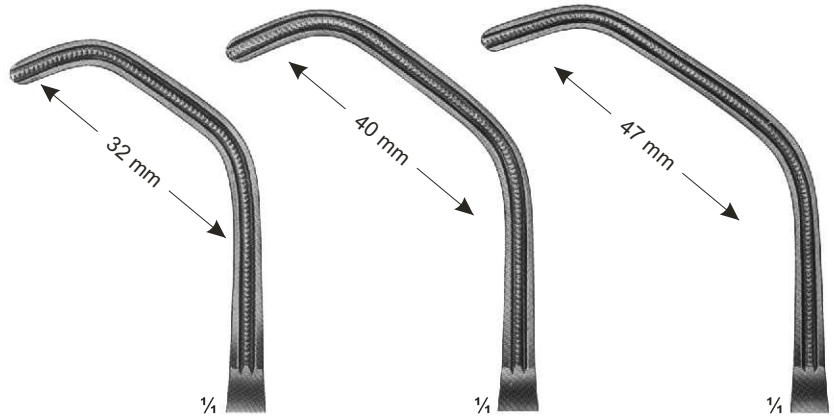

1/4

17-227
68 mm

1/4

17-228
76 mm

1/4

17-229
84 mm



1/2

17-230 - 231
DE BAKEY
170 mm, 165 mm

1/4

17-230
50 mm

1/4

17-231
50 mm



1/2

17-232
DE BAKEY
165 mm

1/4

50 mm

Vena-Cava Clamps



17-233 - 235
DE BAKEY
205 mm, 225 mm, 240 mm



17-233 41 mm
17-234 65 mm
17-235 80 mm



17-236 - 238
DE BAKEY
200 mm, 225 mm, 240 mm



17-236 41 mm
17-237 65 mm
17-238 80 mm

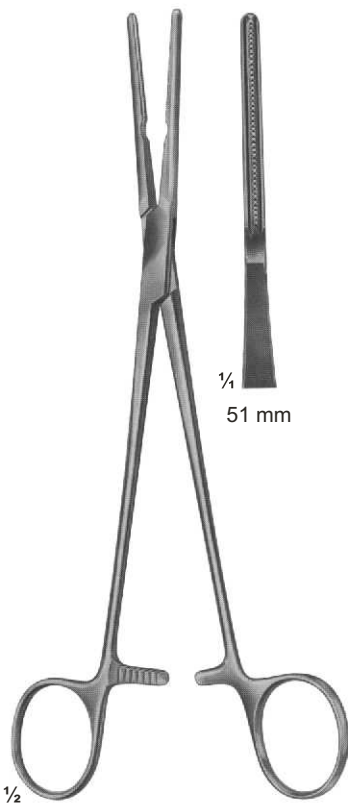

17-239
DE BAKEY
210 mm



1/4
51 mm



17-240
DE BAKEY
210 mm

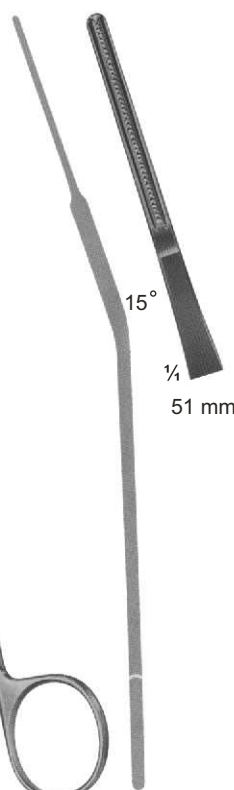

15°
1/4
51 mm



17-241
DE BAKEY
160 mm



1/4
56 mm

Vena-Cava Clamps

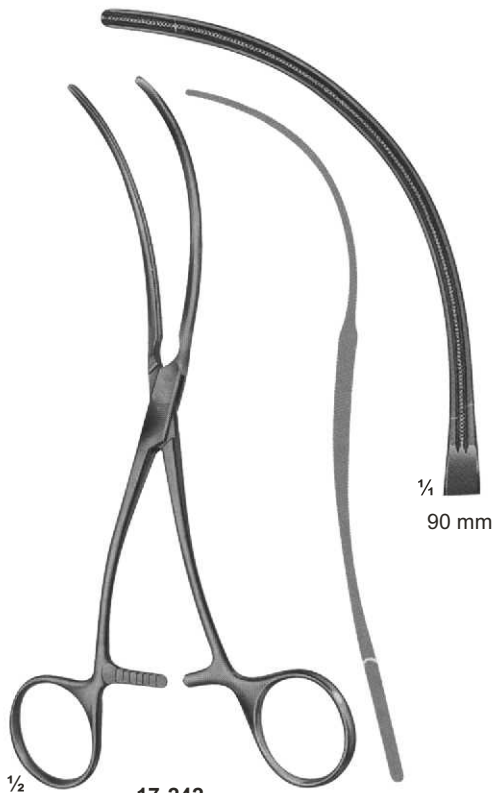

1/2
17-242
 DE BAKEY
 190 mm

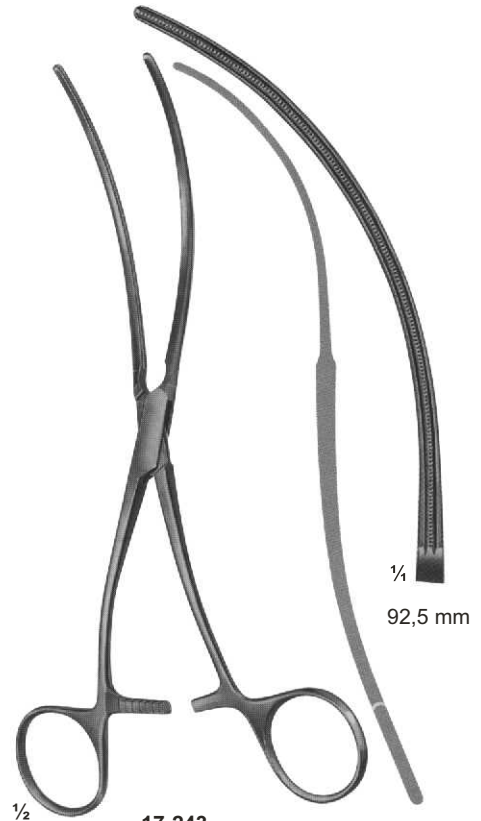

1/2
17-243
 DE BAKEY
 200 mm

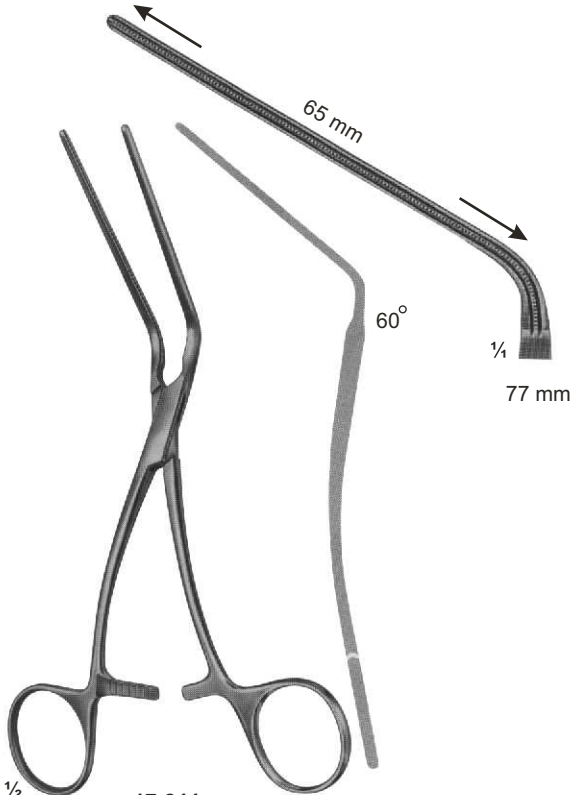

1/2
17-244
 DE BAKEY
 180 mm

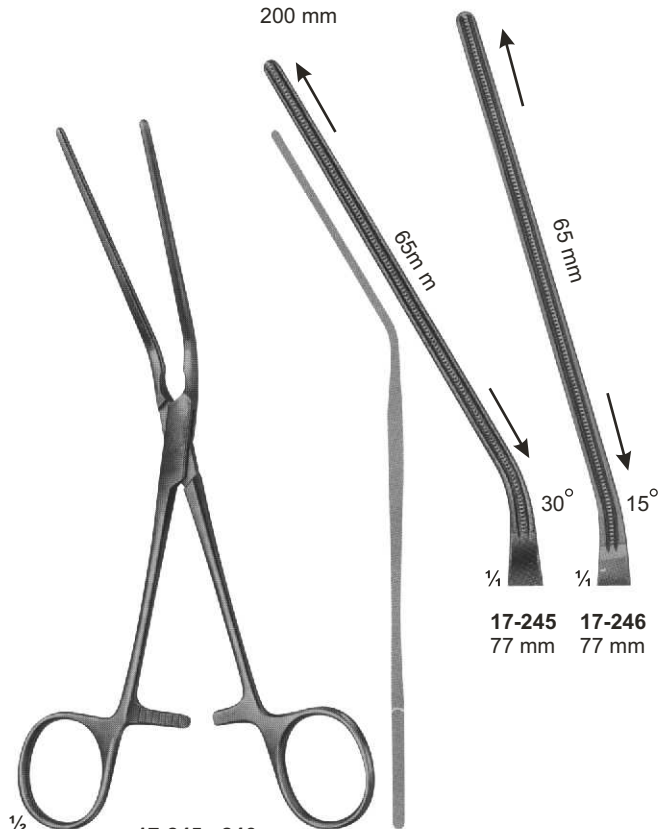

1/2
17-245 - 246
 DE BAKEY
 190 mm

17-245 77 mm
17-246 77 mm

Vena-Cava Clamps



17-247
LELAND-JONES
195 mm



17-248
DE BAKEY
200 mm



Iliac clamp



17-249
WERTHEIM
250 mm

Vena-Cava Clamps

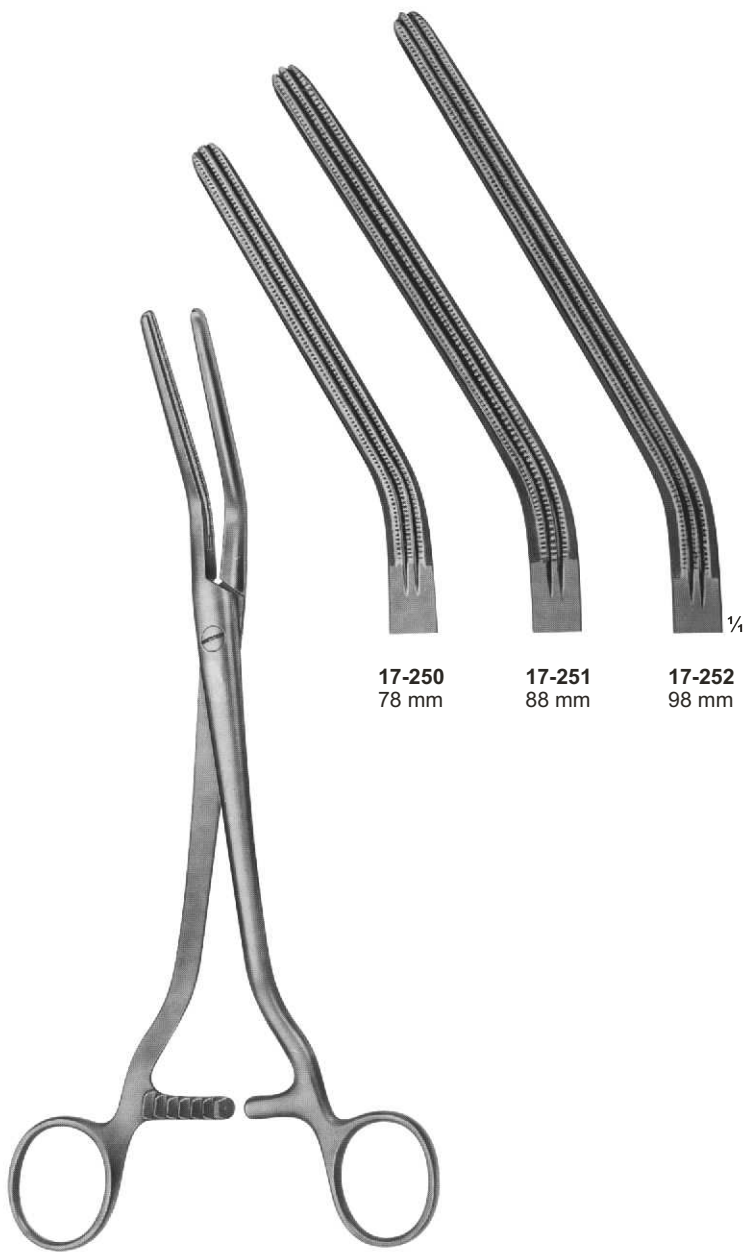

17-250
78 mm

17-251
88 mm

17-252
98 mm

17-250 - 252
DICK
255 mm, 265 mm, 275 mm

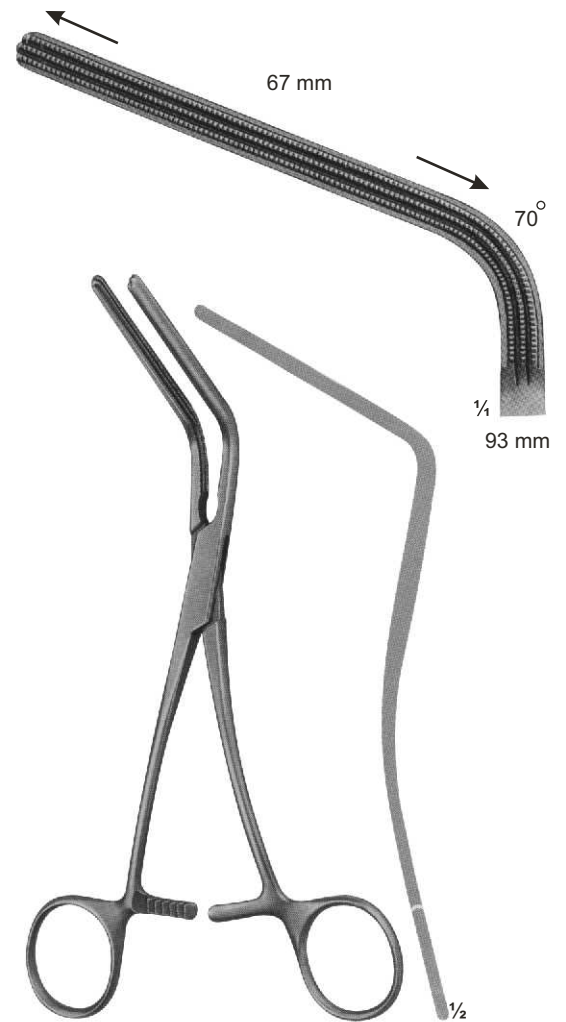

67 mm

70°

93 mm

17-253
MORRIS
175 mm

Vena-Cava Clamps

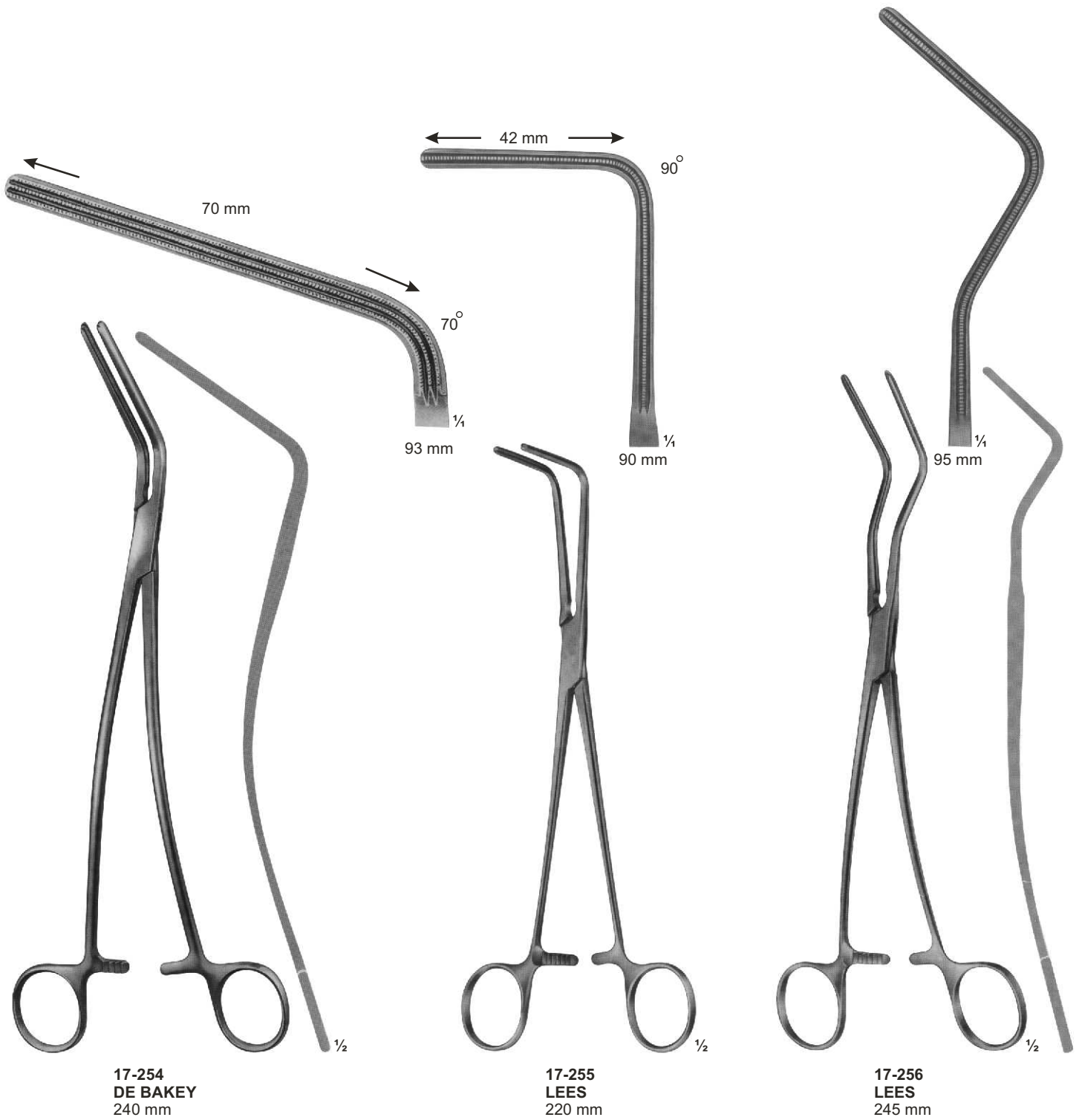

Vena-Cava Clamps

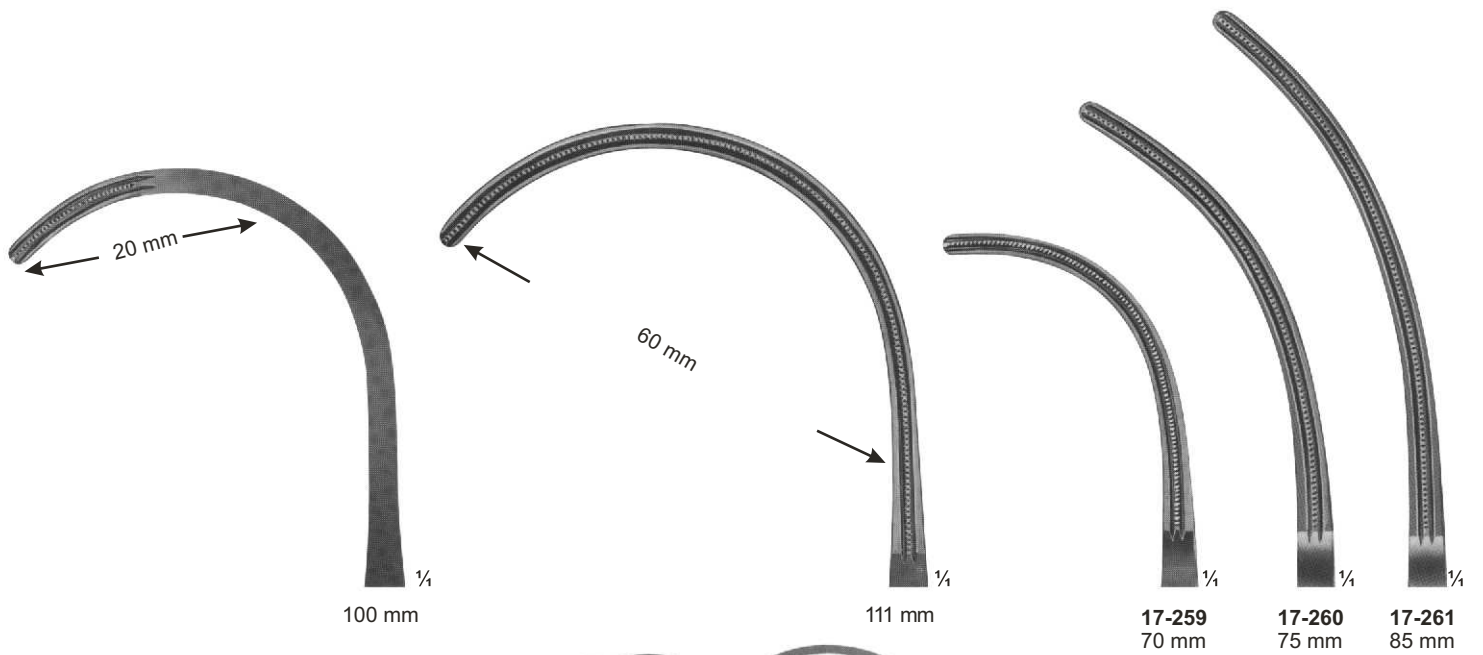

**17-257
DE BAKEY**
265 mm

**17-258
DE BAKEY**
270 mm

**17-259 - 261
DE BAKEY**
255 mm, 265 mm, 280 mm

Vena-Cava Clamps



17-262 95 mm
17-263 110 mm
17-264 130 mm
17-265 140 mm

17-262 - 265
DE BAKEY
 250 mm, 300 mm,
 315 mm, 330 mm

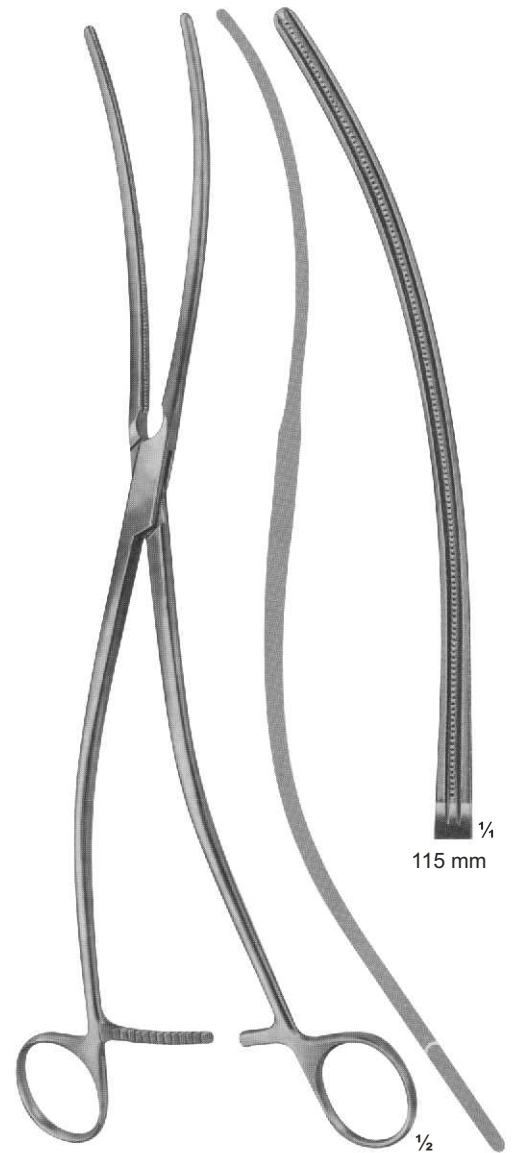

115 mm

17-266
DE BAKEY
 300 mm

Vena-Cava Clamps



**17-267
DIETRICH**
210 mm

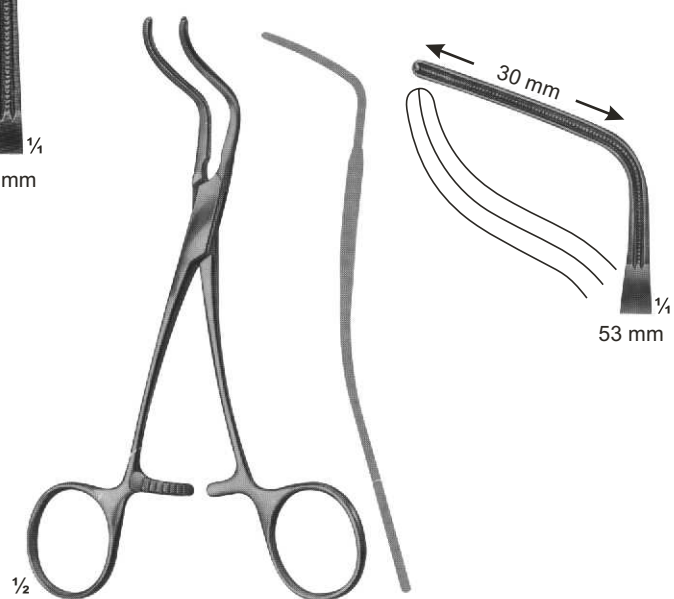

**17-268
SUBRAMANIAN**
155 mm

Vena-Cava Clamps

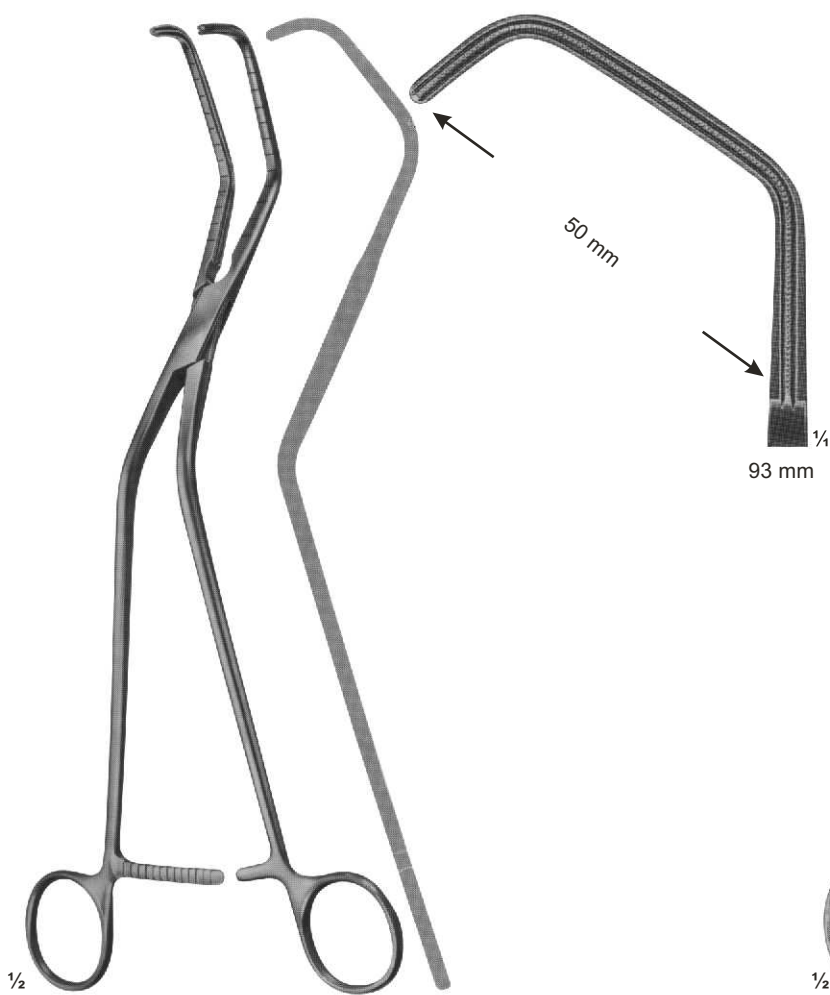

17-269
OCHSNER
260 mm

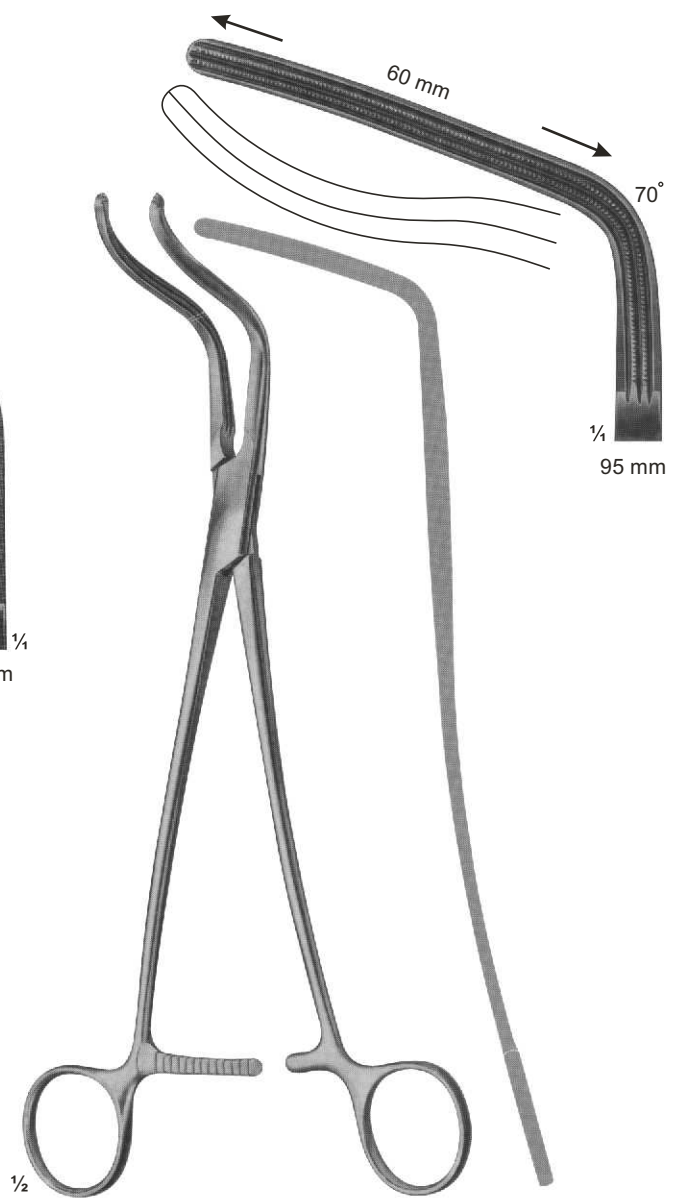

17-270
DE BAKEY
265 mm

Aorta-Anastomosis Clamps



L
17-271
WEBER
265 mm

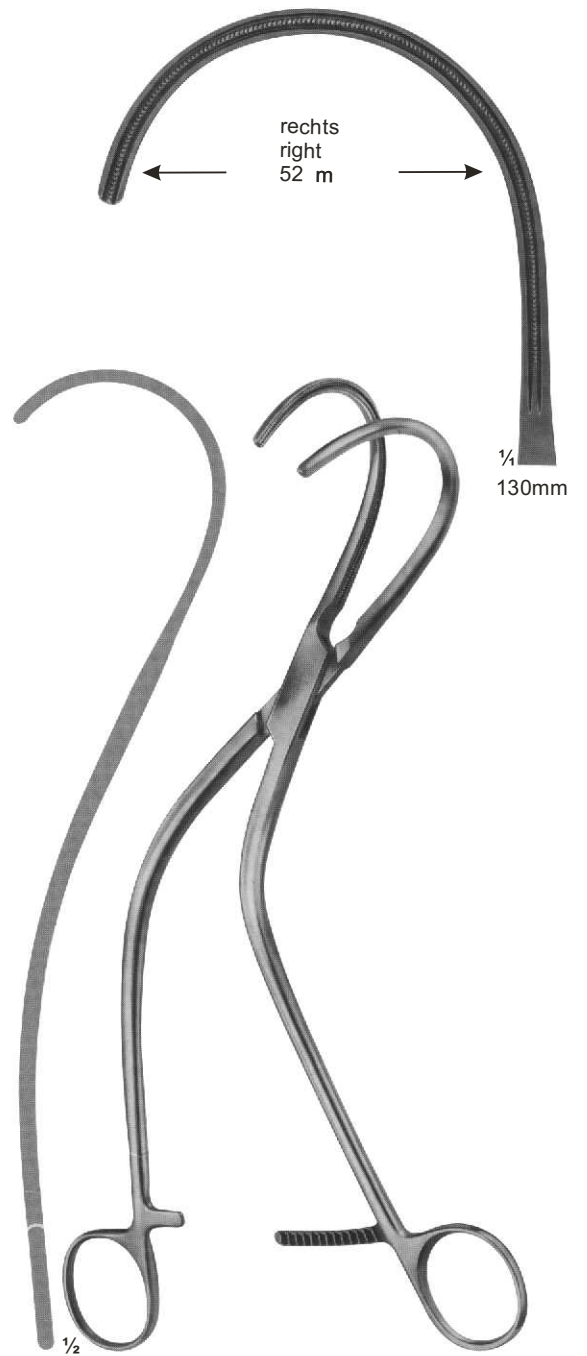

R
17-272
WEBER
265 mm

Aorta-Anastomosis Clamps



1/2
17-273 - 276
DE BAKEY

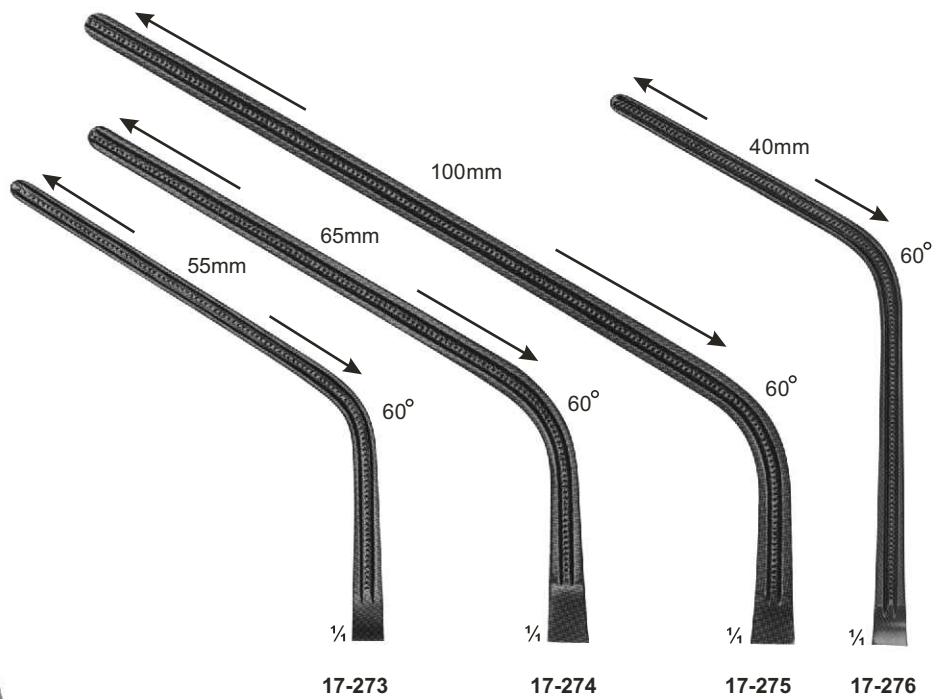

Total Length:	230 mm	280 mm	305 mm	240 mm
Length of jaws:	85 mm	100 mm	135 mm	93 mm



1/2
17-277 - 280
DE BAKEY

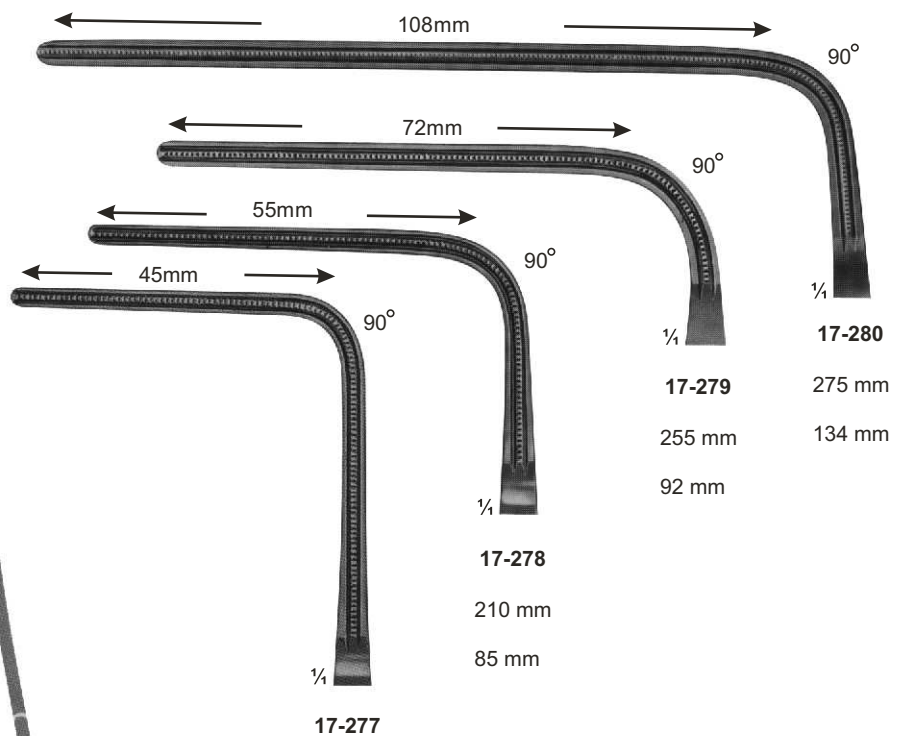

Total Length:	225 mm
Length of jaws:	93 mm

Aorta-Anastomosis Clamps

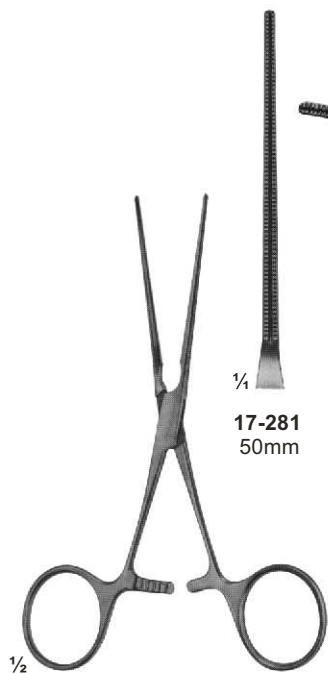

17-281
50mm



17-282
50mm

17-281 - 282
COOLEY
125 mm, 115 mm



1/2

17-283
COOLEY
100 mm

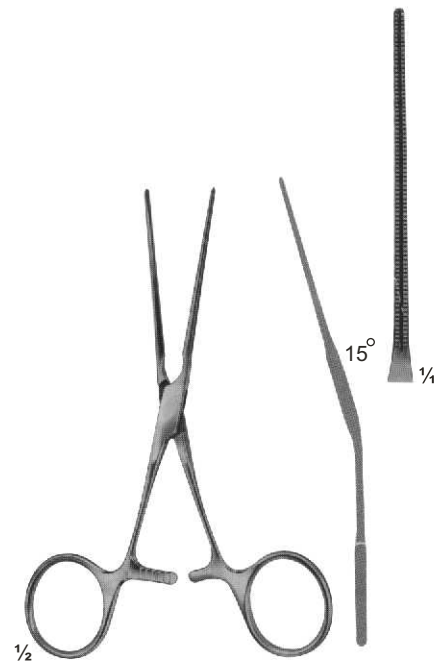

1/2

17-284
COOLEY
125 mm

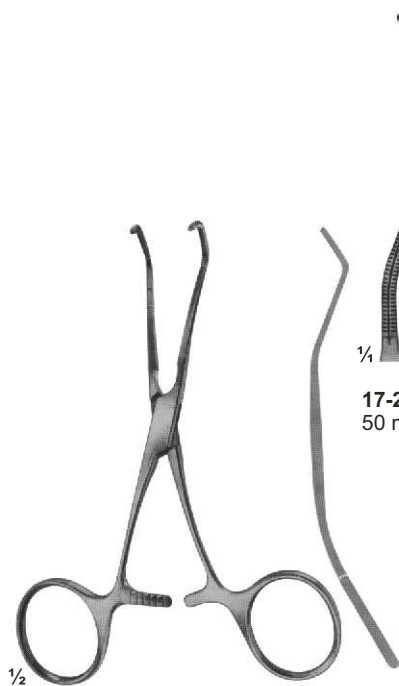

1/2

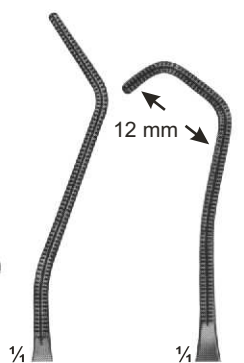

17-285
50 mm

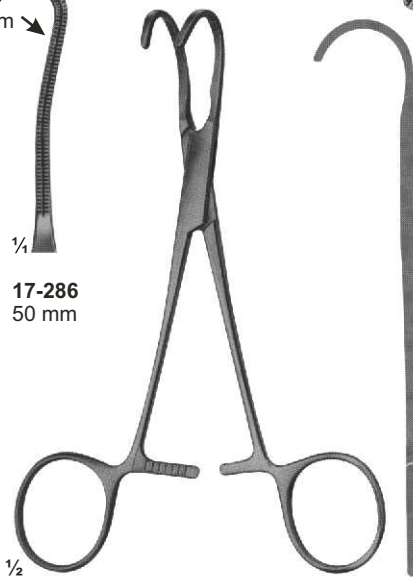

1/2

17-287 - 288
COOLEY-BACK
150 mm, 115 mm

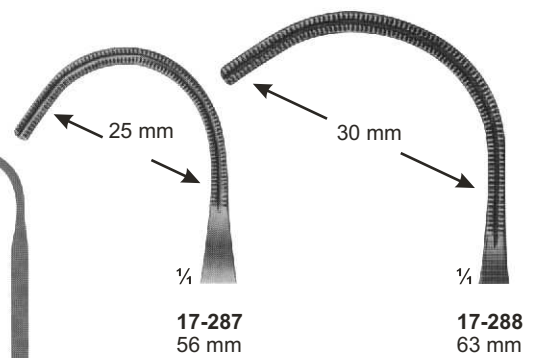

17-287
56 mm

17-288
63 mm

Aorta-Anastomosis Clamps

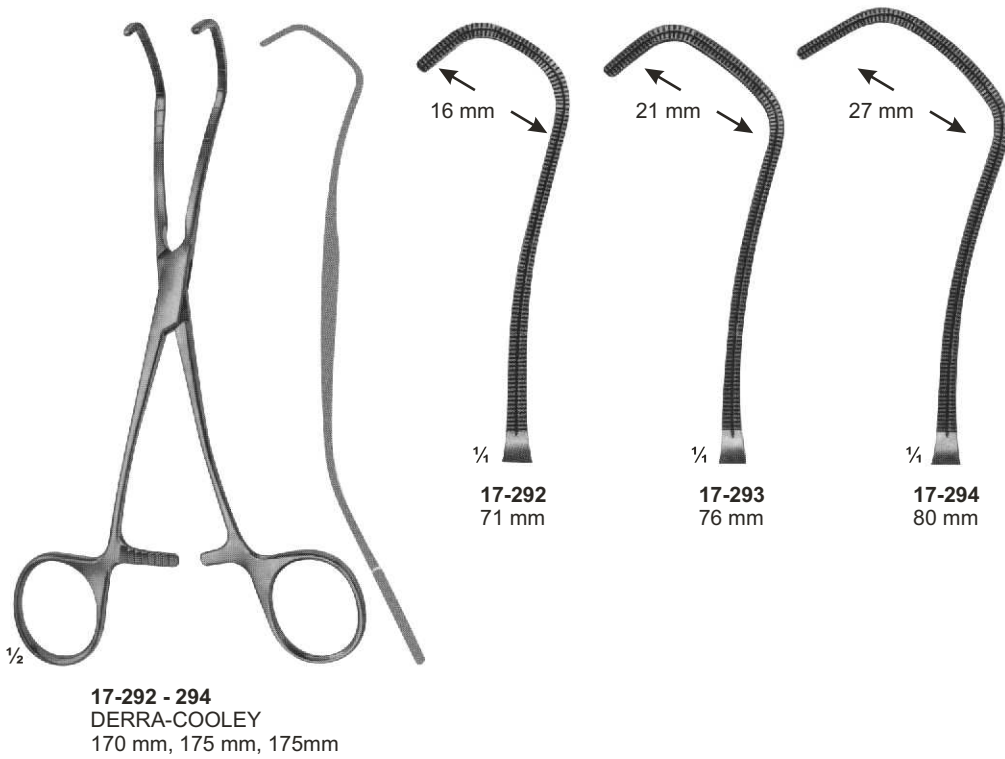
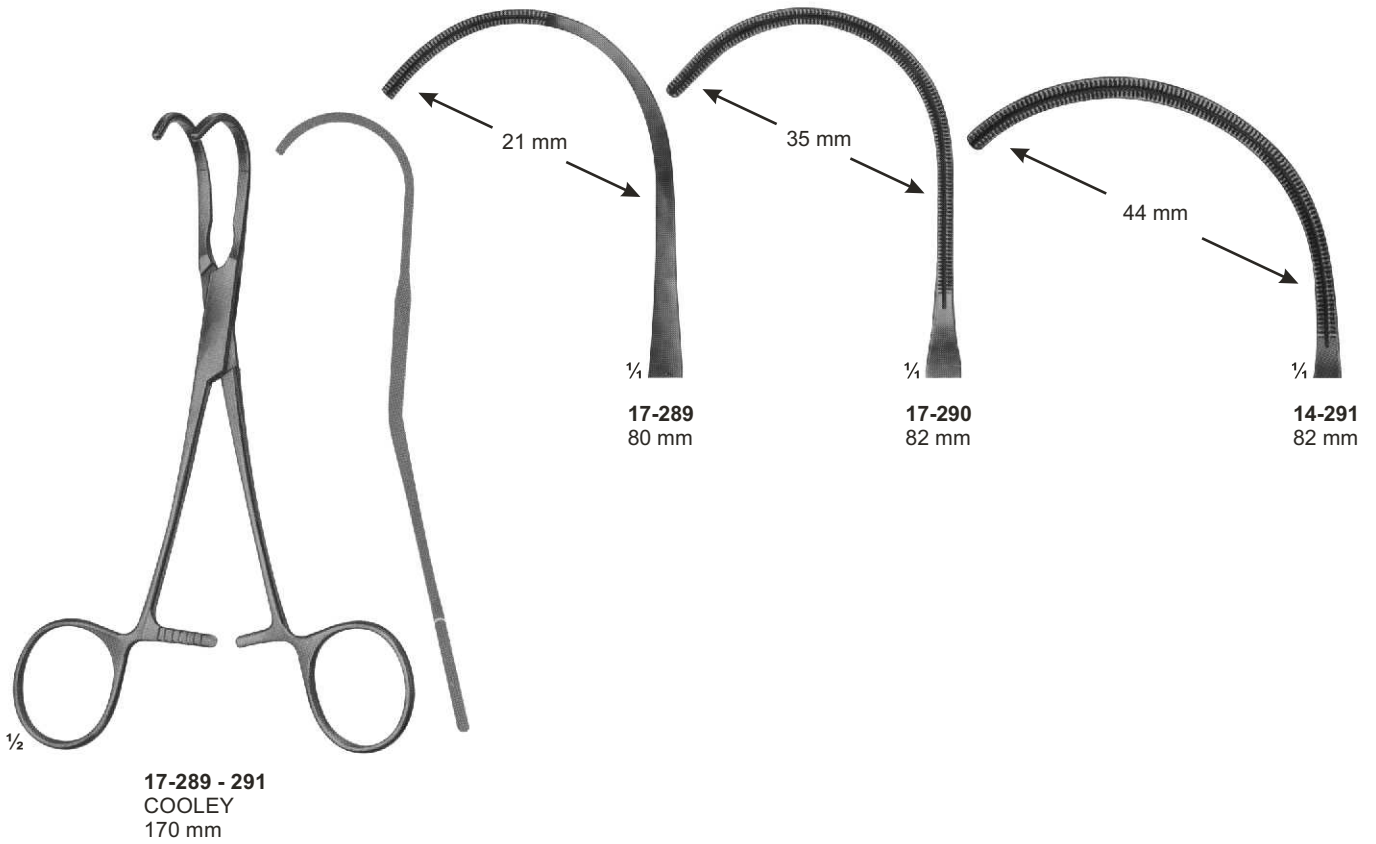

Aorta-Anastomosis Clamps

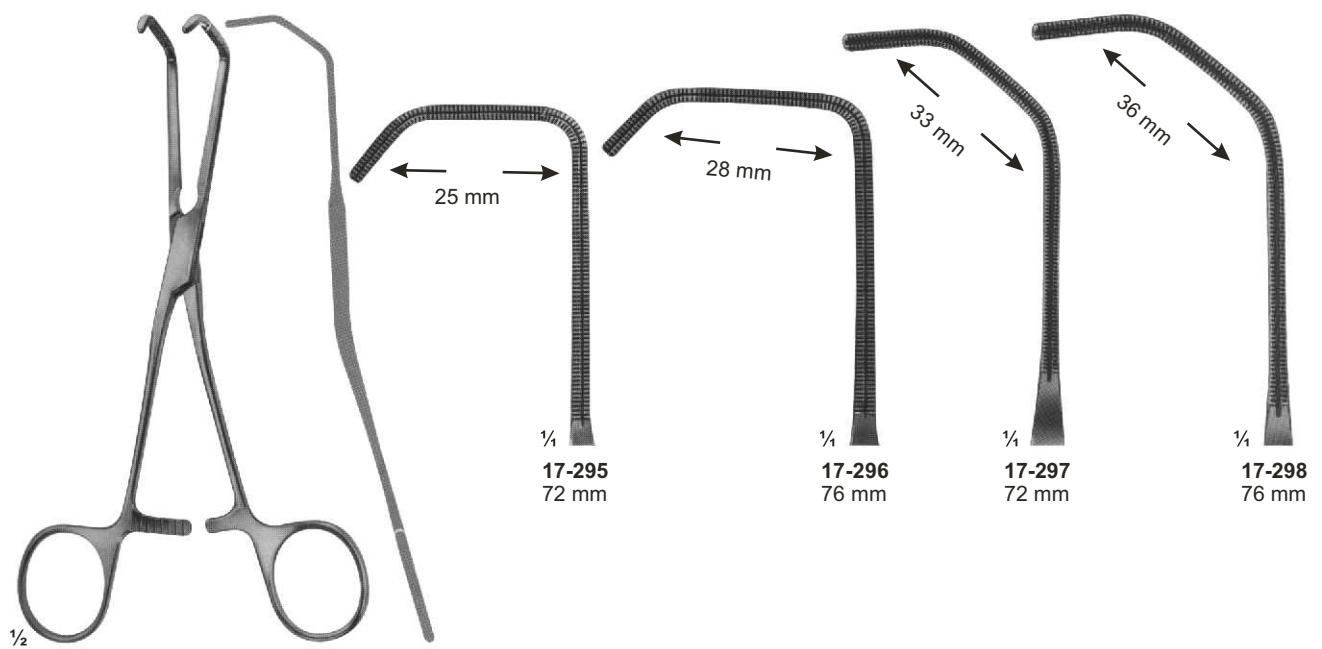

17-295 - 298
COOLEY
 165 mm, 165 mm
 175 mm, 180 mm

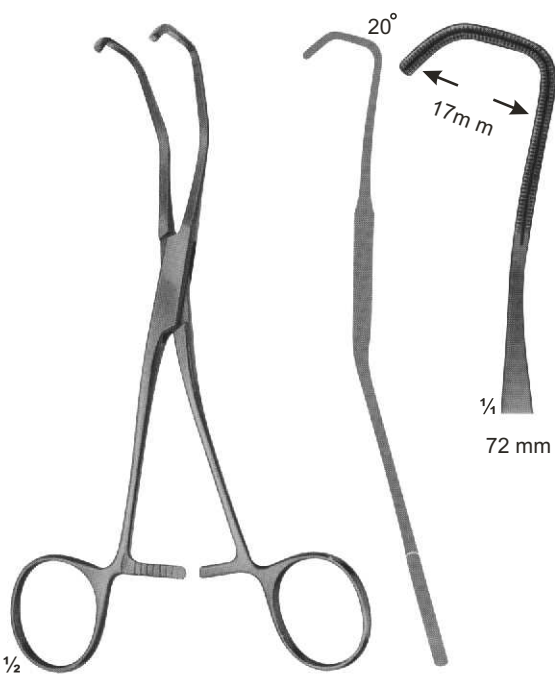

17-299
COOLEY
 170 mm

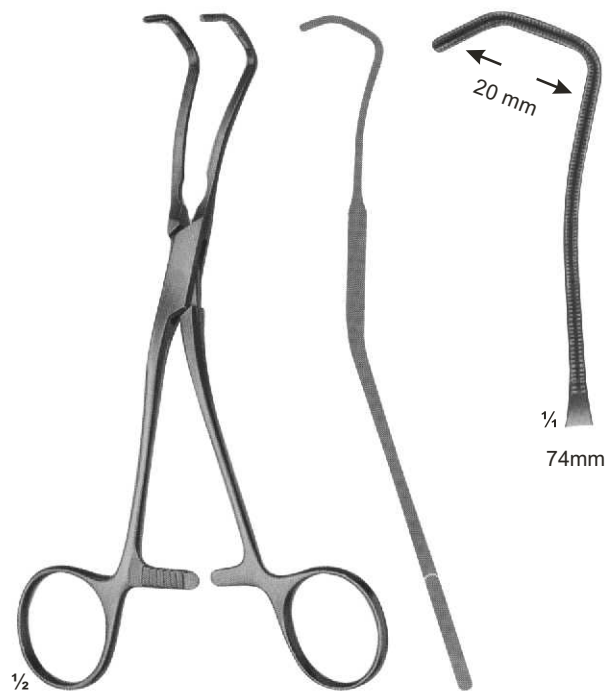

17-300
COOLEY
 175 mm

Aorta-Anastomosis Clamps

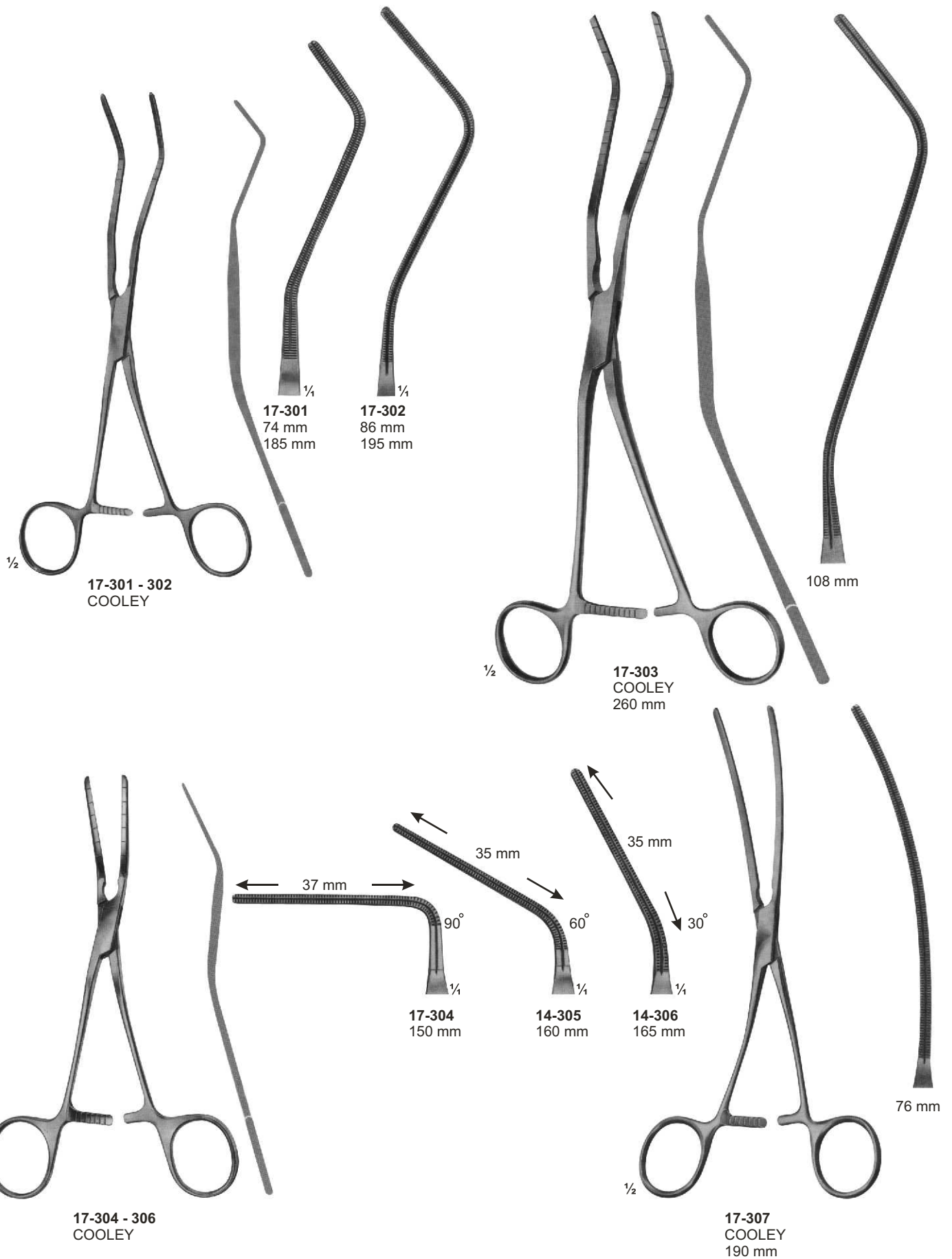

Aorta-Anastomosis Clamps

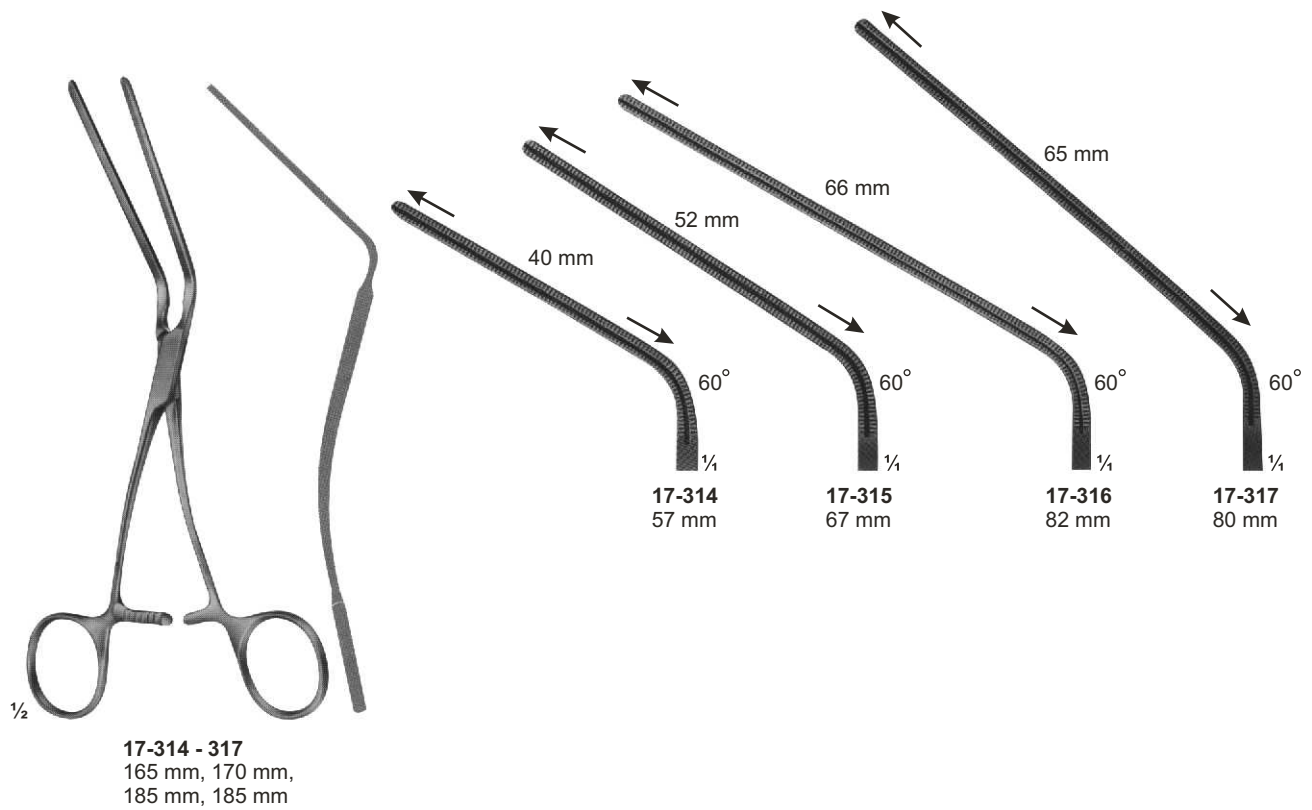
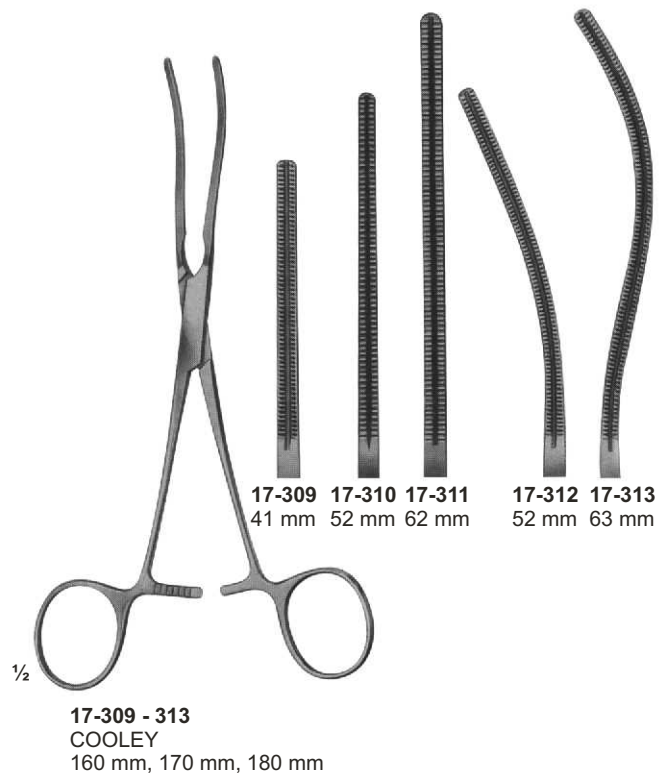
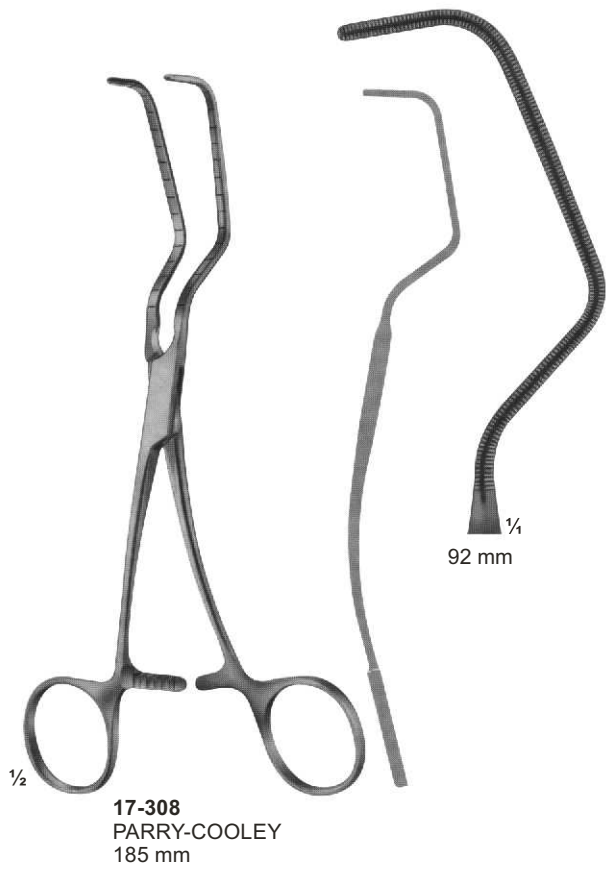

Multi-Purpose Clamps



DARDIK			
17-318	150 mm	17-323	170 mm
17-319	150 mm	17-324	170 mm
17-320	150 mm	17-325	170 mm
17-321	145 mm	17-326	160 mm
17-322	130 mm	17-327	135 mm

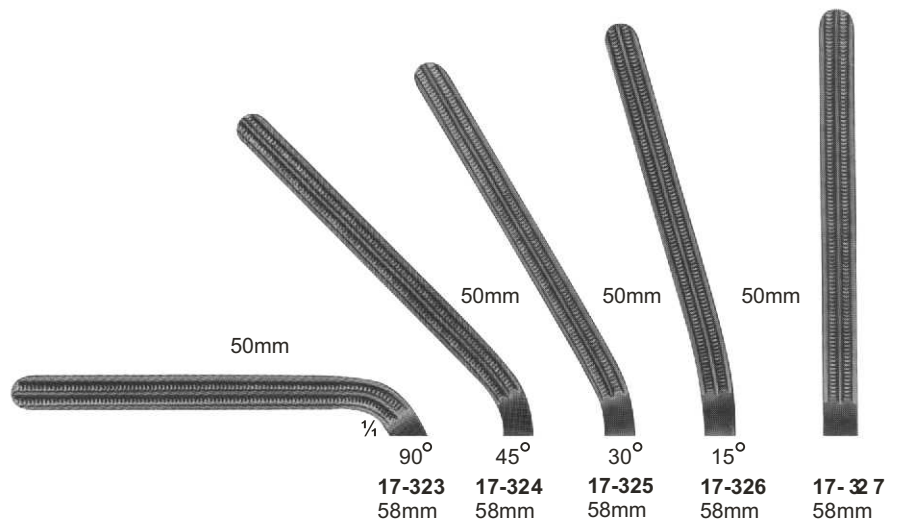
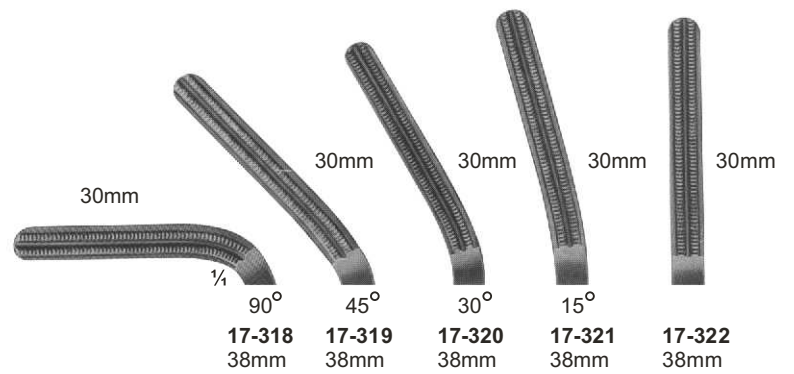

Multi-Purpose Clamps

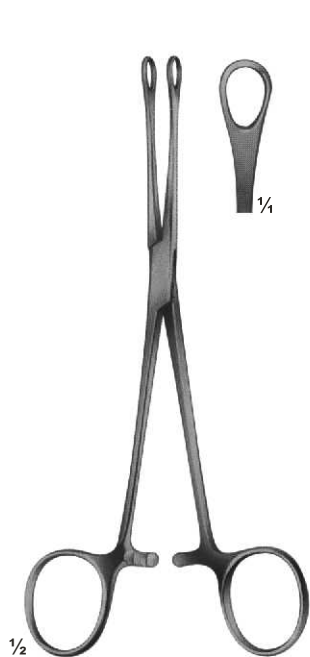

17-328
WILLIAMS
160 mm



17-329
TUTTLE
230 mm



17-330
NELSON
230 mm

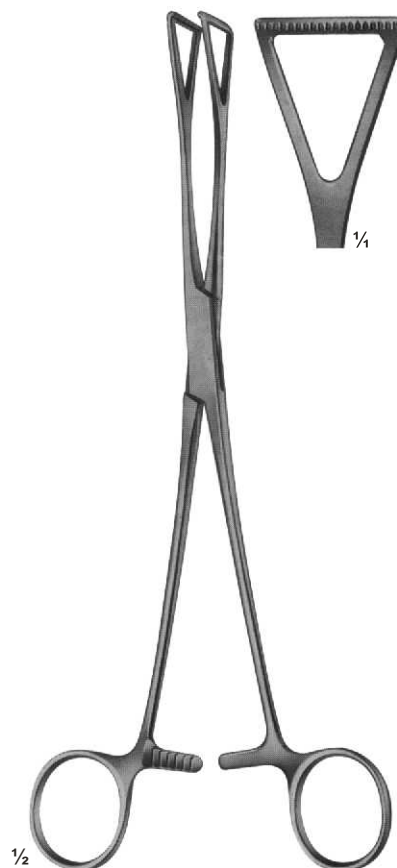

17-331
DUVAL
230 mm

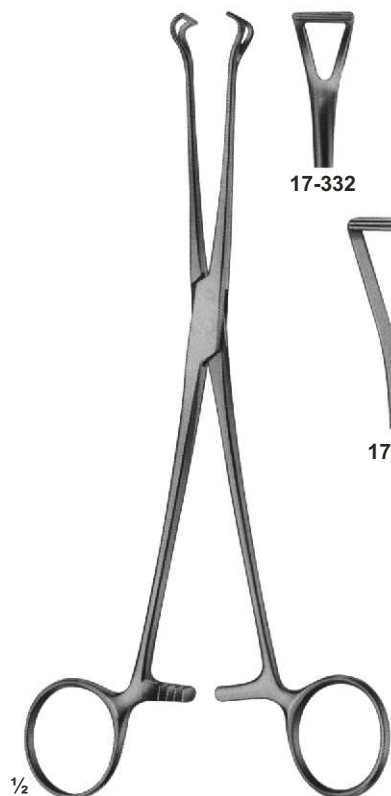

BABCOCK
17-332 170 mm
17-333 215 mm
17-334 220 mm

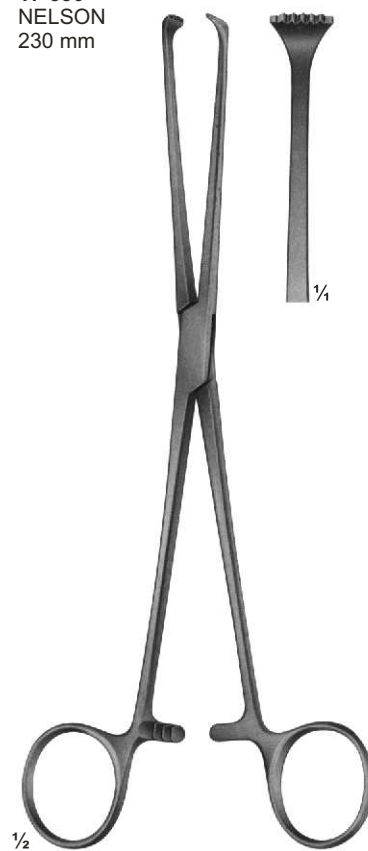
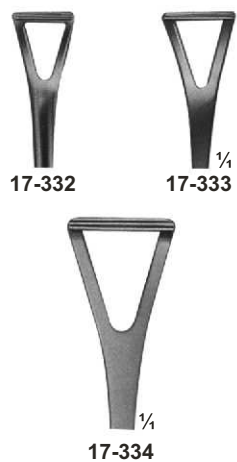

17-335
ALLIS
220 mm

Multi-Purpose Clamps

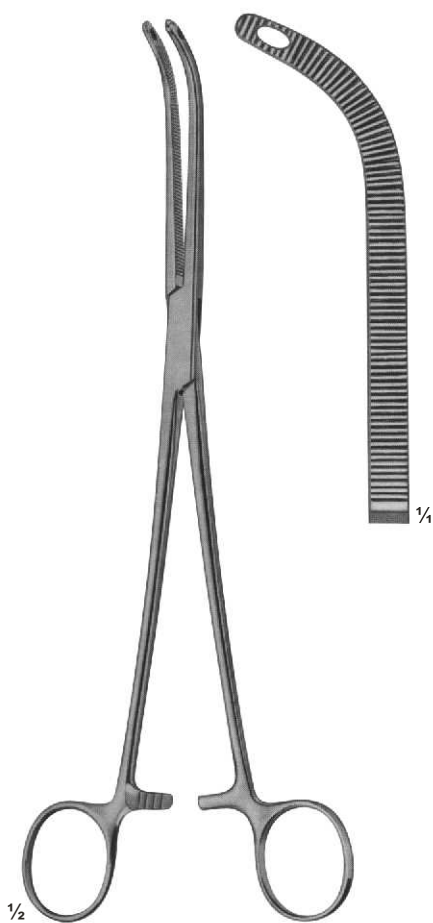

17-336
FINOCHIETTO
245 mm

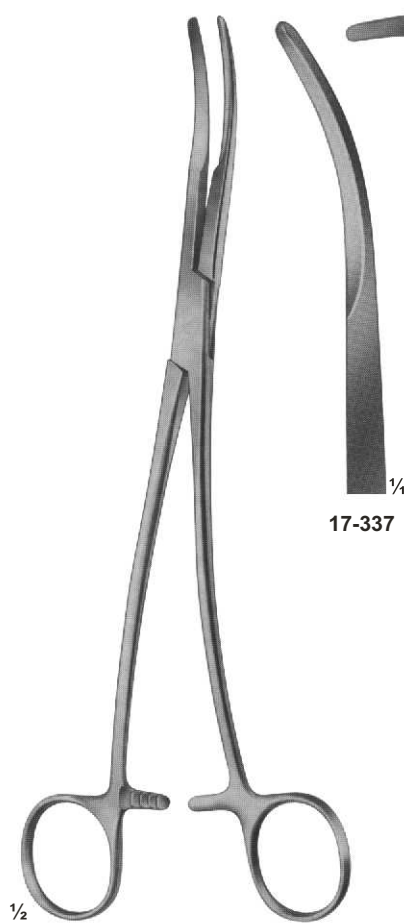

17-337

17-337 - 338
SEMB
244 mm

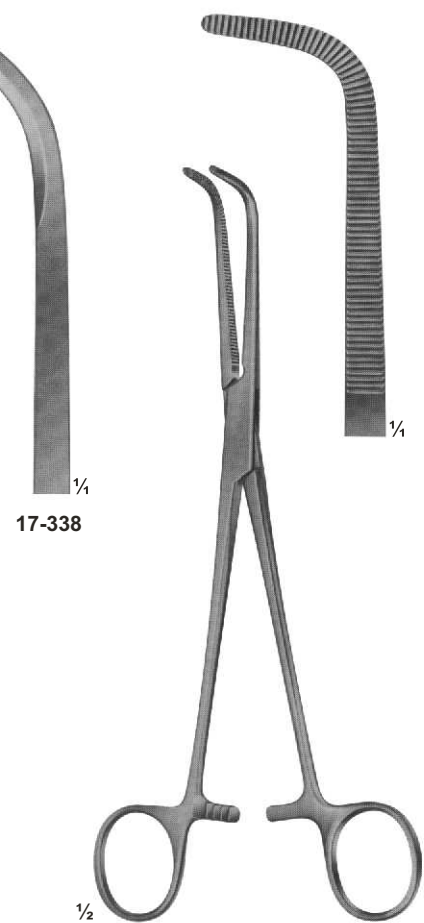

17-338

17-339
WIKSTROEM
205 mm

Multi-Purpose Clamps

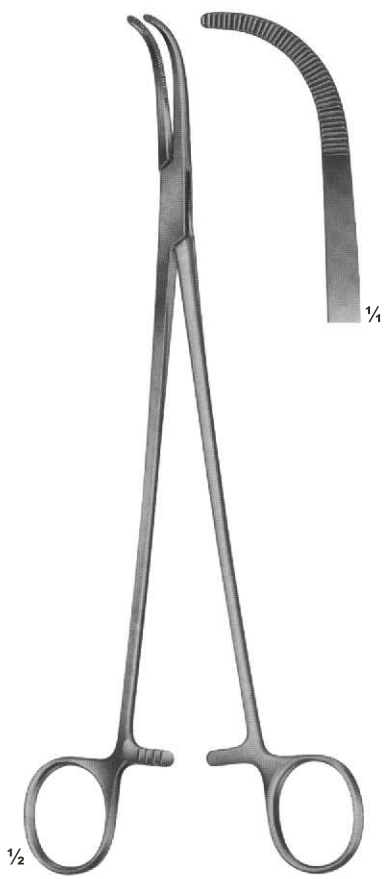

17-340
MIXTER
230 mm

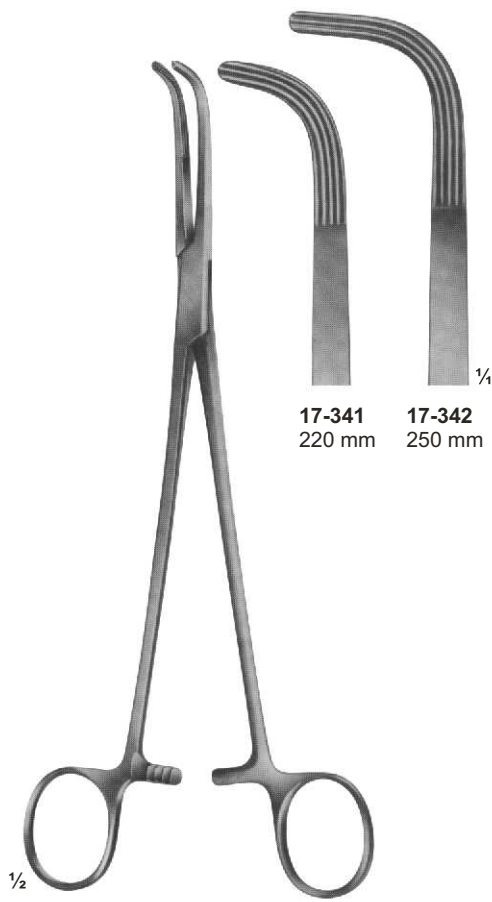

17-341 220 mm
17-342 250 mm

17-341 - 342
MIXTER

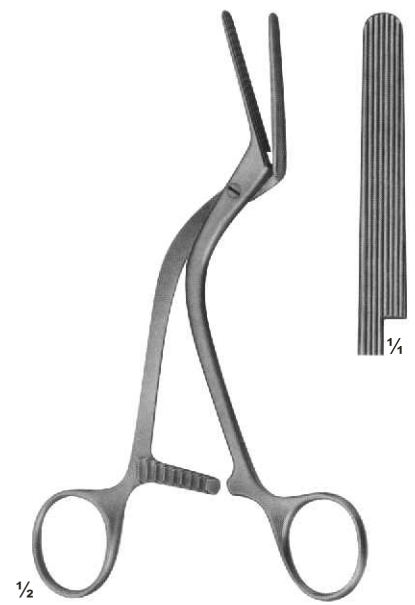

17-343
HOPFNER
160 mm

Multi-Purpose Clamps

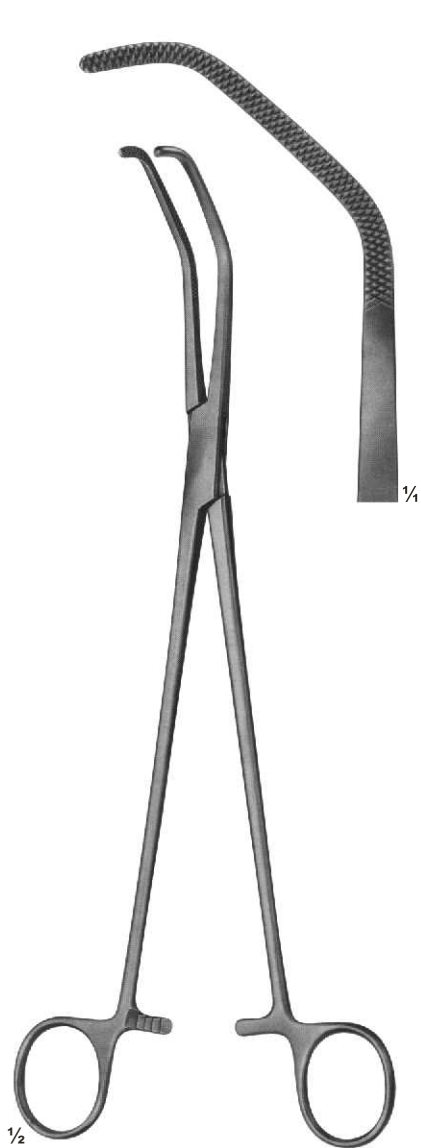

17-344
SATINSKY
265 mm



17-345
SATINSKY
265 mm

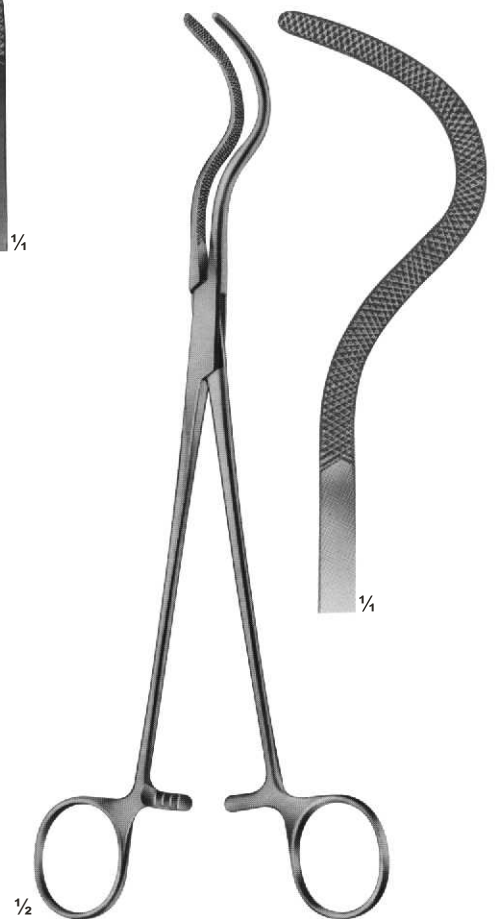

17-346
HARKEN
240 mm

Multi-Purpose Clamps



17-347
PERTUISET
Carotid Clamp
90 mm

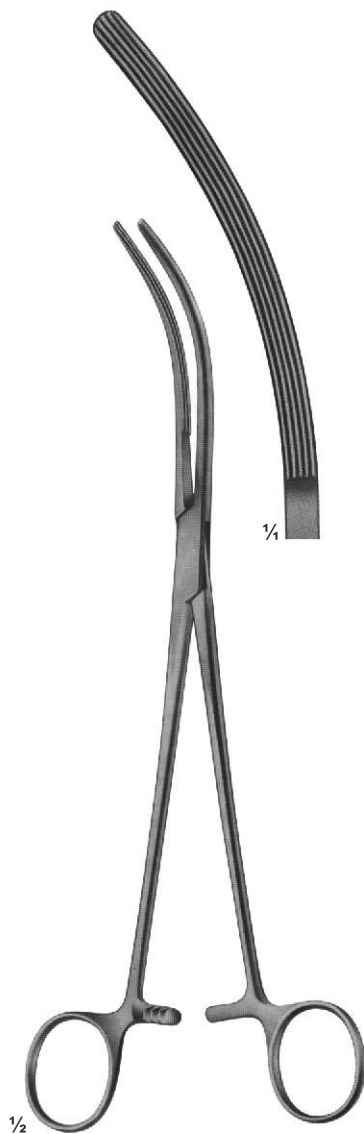

17-348
CRAFOORD-SELLORS
240 mm

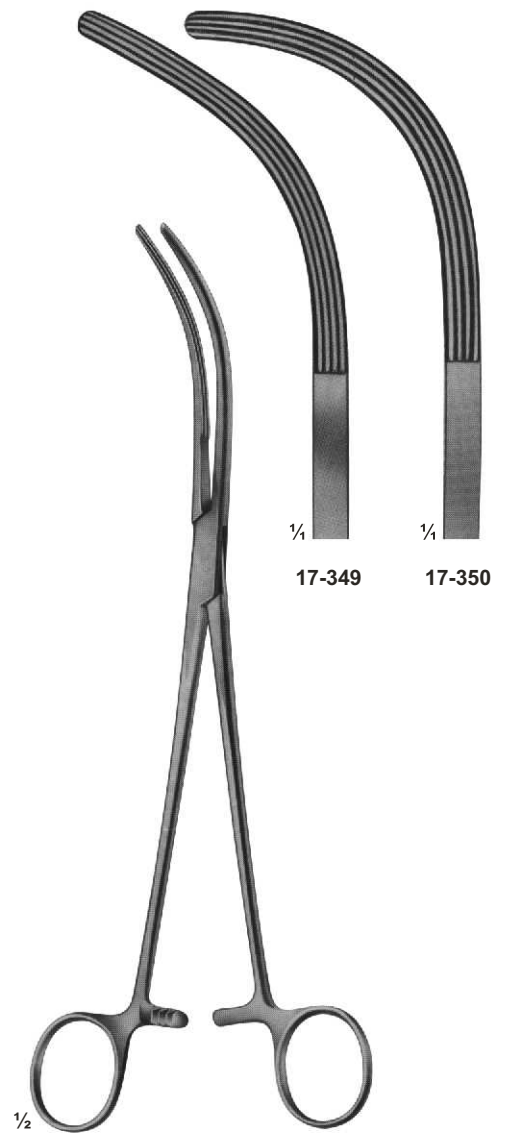

17-349 - 350
CRAFOORD
240 mm

Multi-Purpose Clamps



17-351
PRICE THOMAS
225 mm

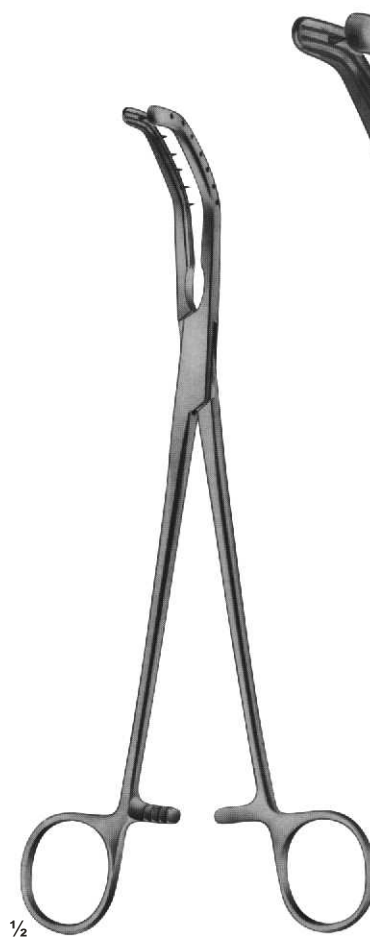

17-352 - 353
PRICE THOMAS
225 mm

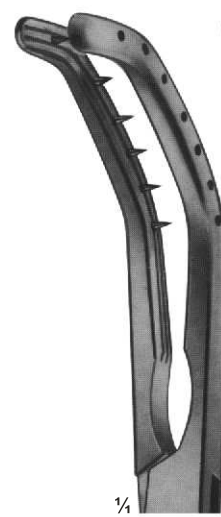

17-352
jaws with pins

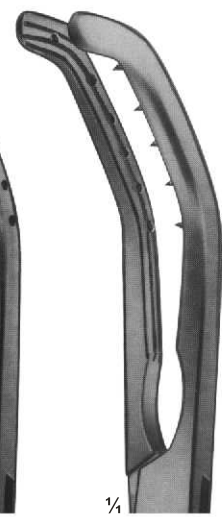

17-353
jaws with pins

Rib Shears



17-354
SCHUMACHER
Sternum shears
210 mm



17-355
LEBSCHKE
Sternum chisel
200 mm



17-356
230 mm



17-357
COLLIN
195 mm



17-358
GLUCK
190 mm



17-359
GLUCK
190 mm



17-360
BRUNNER
Universal Pattern
340 mm



17-361
GIERTZ-STILLE
250 mm

Rib Holding Forceps, Bone Cutting Forceps

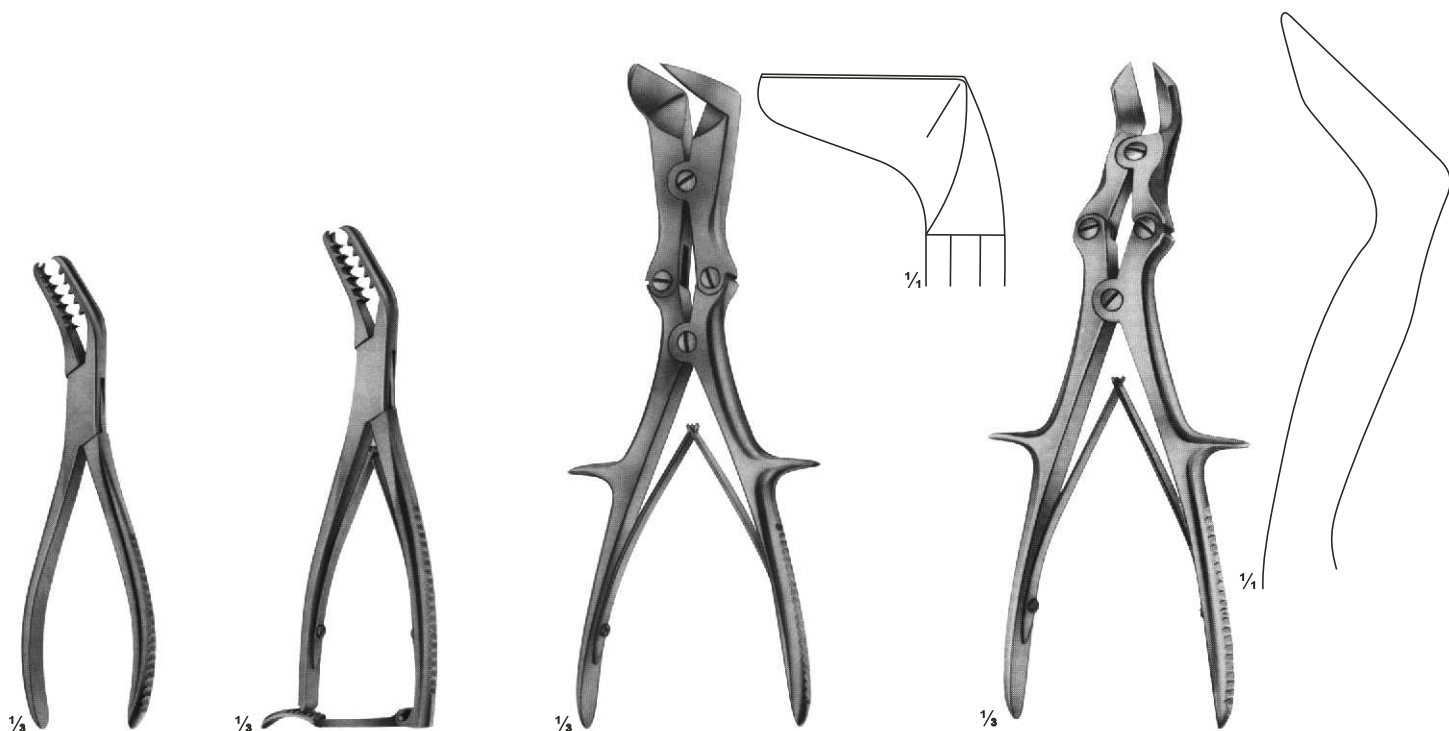

17-362
SEMB
Rib-and Bone
Holding forceps
190 mm

17-363
SEMB
Rib-and Bone
Holding forceps
190 mm

17-364
LISTON-STILLE
265 mm

17-365
LISTON-KEY-HORSLEY
255 mm

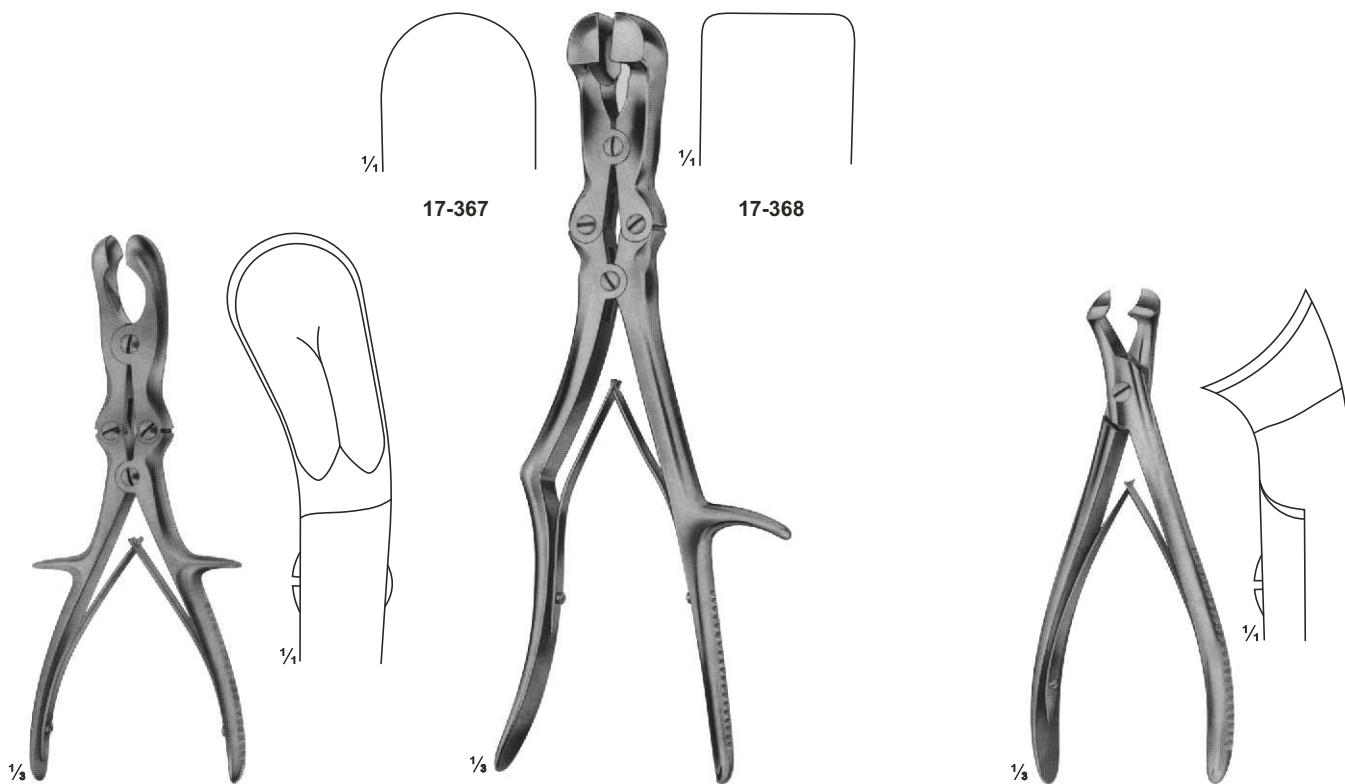

17-366
SEME
Rib Rongeur to shorten
the rib stumps
240 mm

17-367-368
SAUERDRUCH-CORYLLOS
Rib rongeurs to shortn
the rib stumbe
310 mm

17-369
MARKWALDER
Rib Rongeur to Round
the rib stumps
190 mm

Rib Raspatories

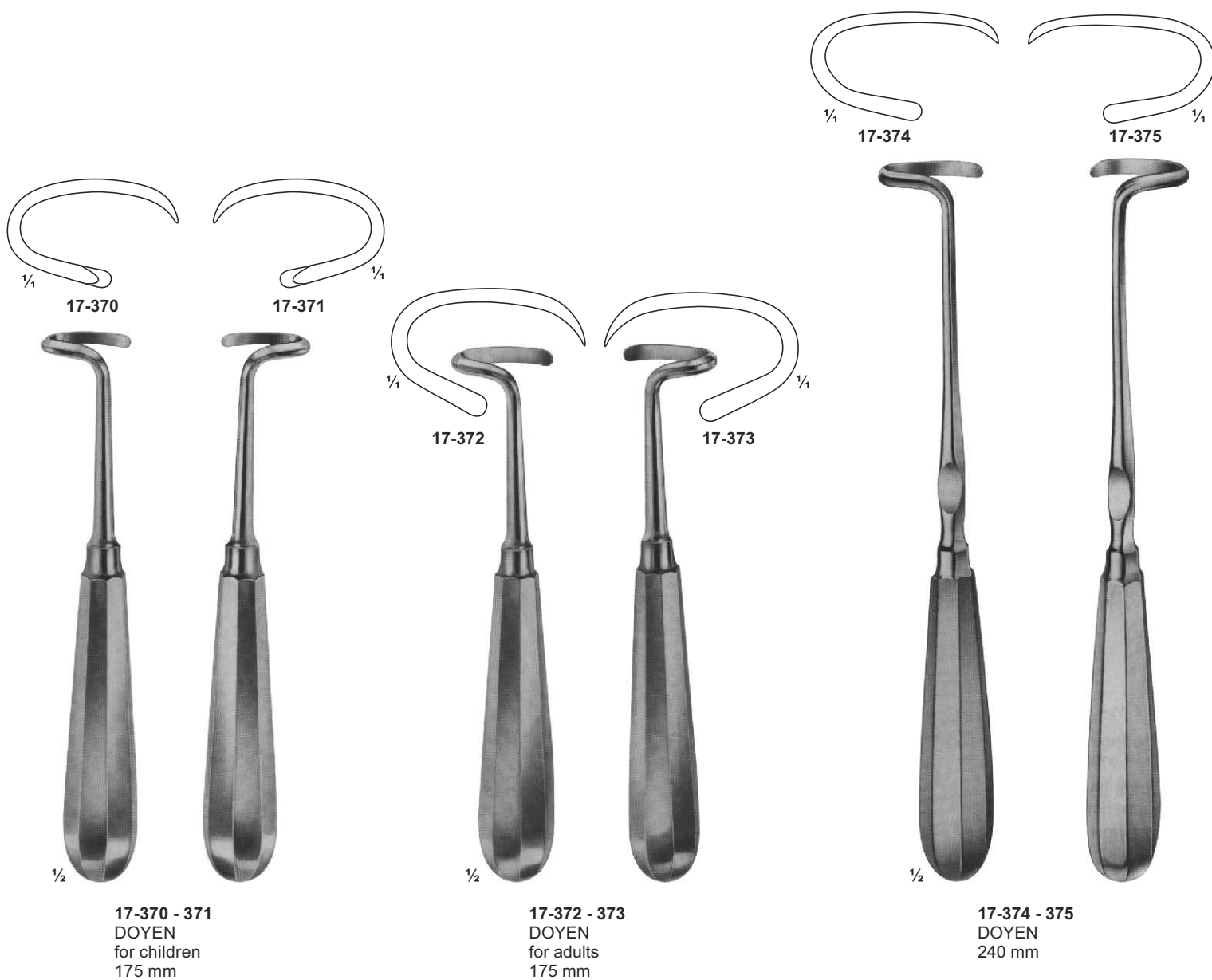

Rib Raspatories

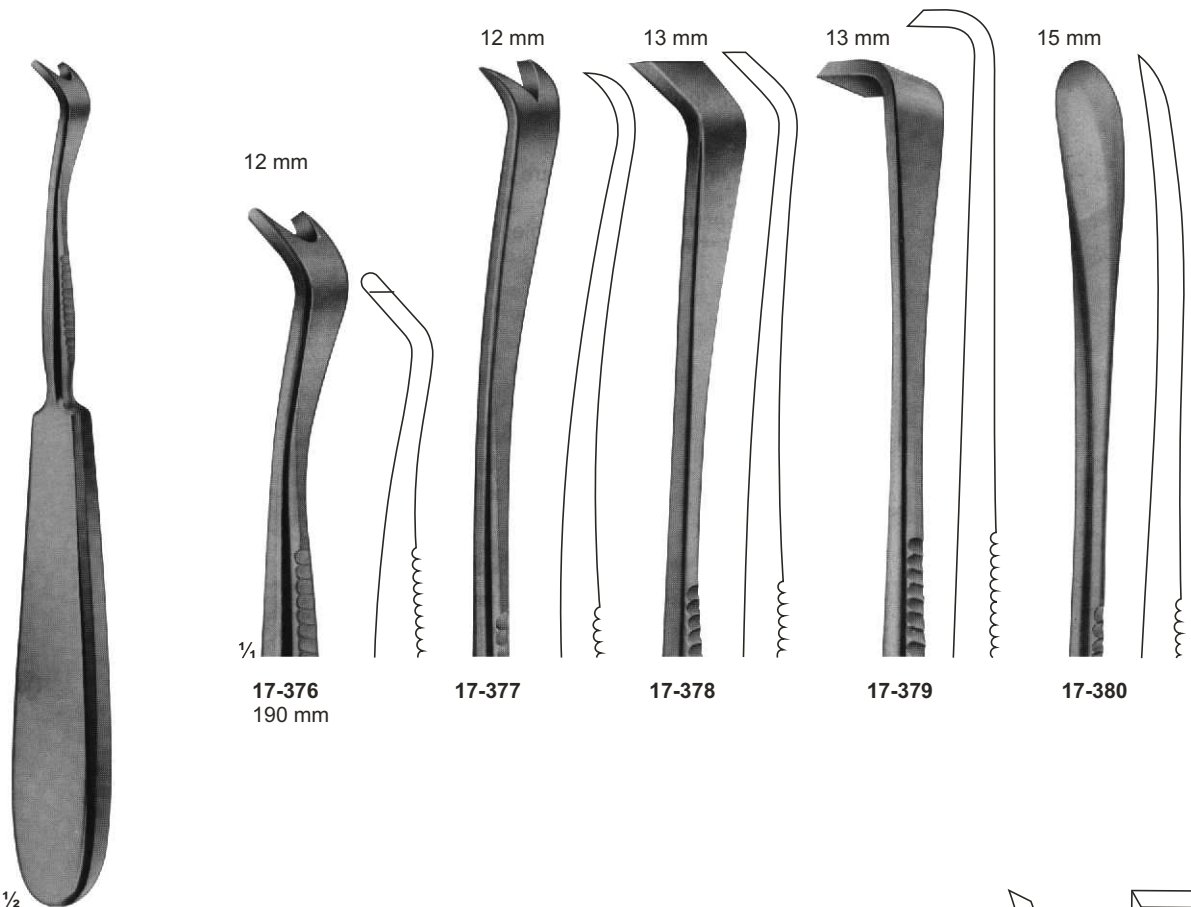

1/2
17-376 - 380
SEMB
230 mm

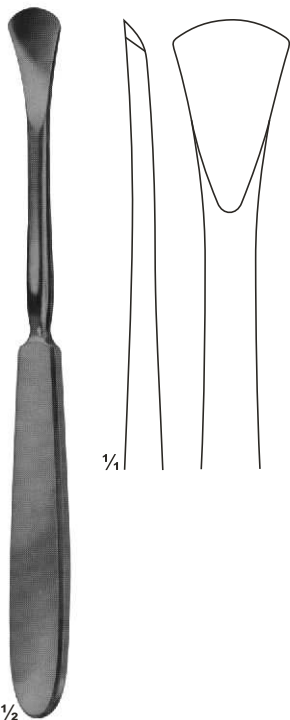

17-381
LANGENBECK
190 mm

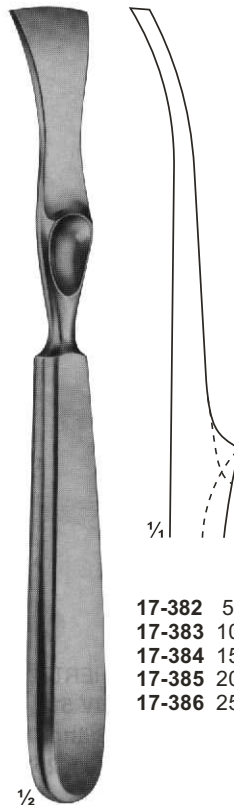

17-382 5 mm
17-383 10 mm
17-384 15 mm
17-385 20 mm
17-386 25 mm

17-382 - 386
LAMBOTTE
215 mm

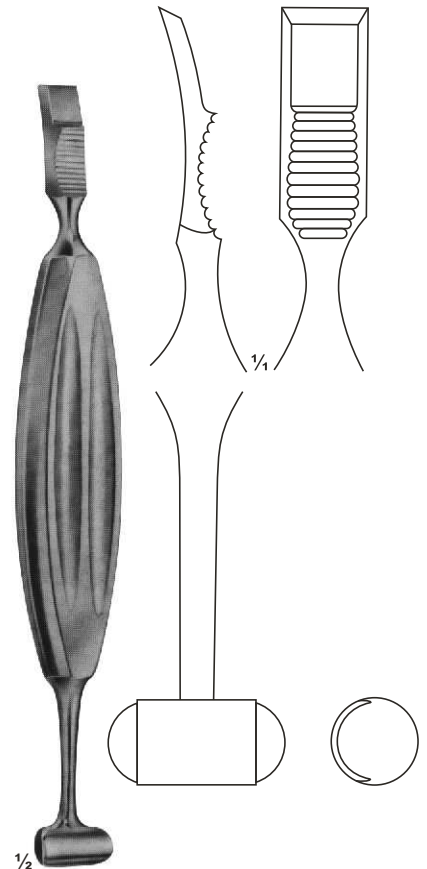

17-387
ALEXANDER
210 mm

Rib Spreaders

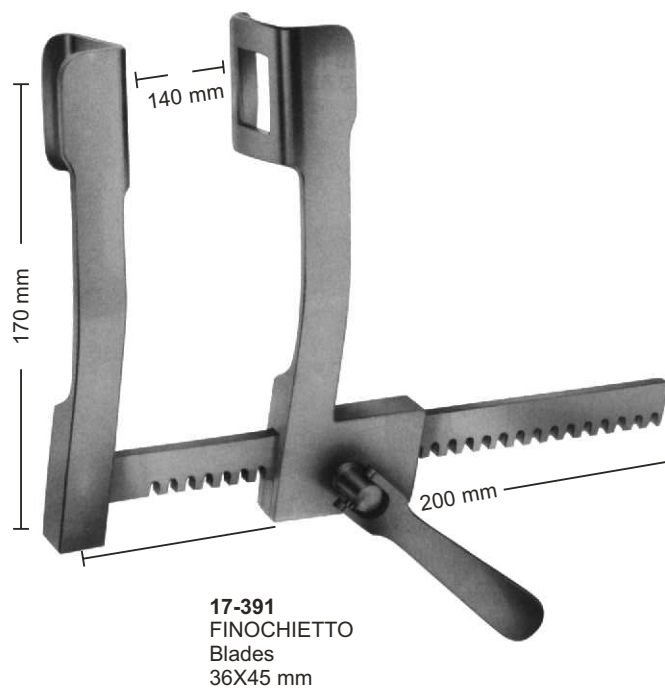
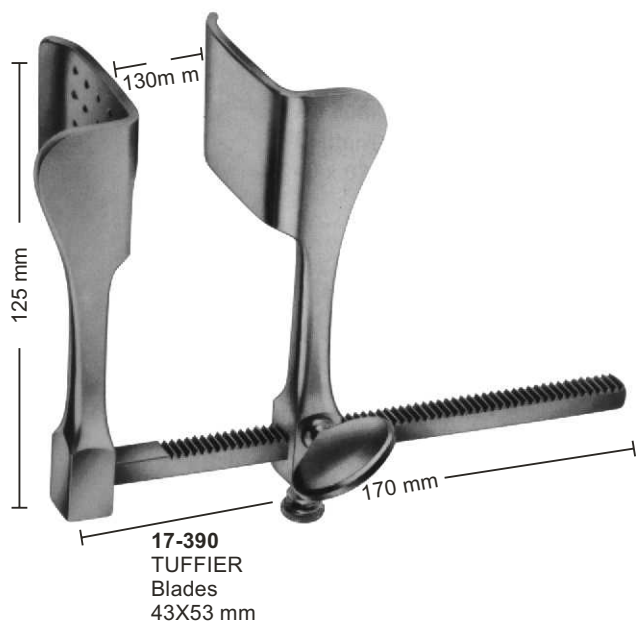
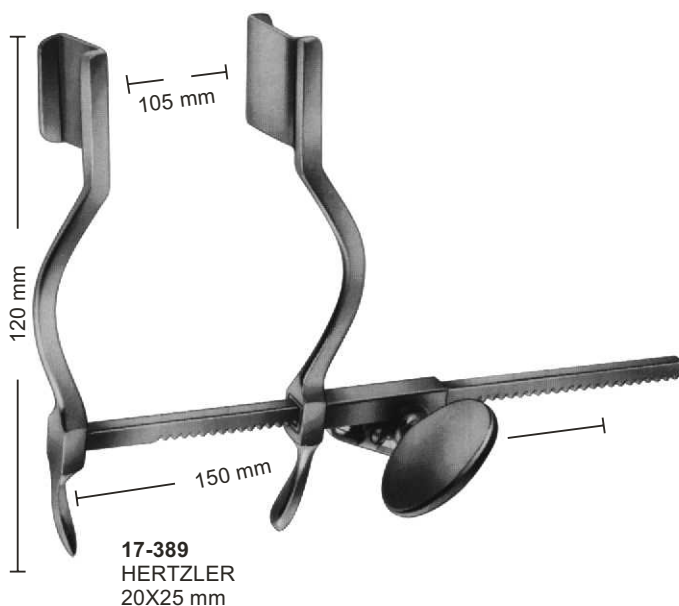
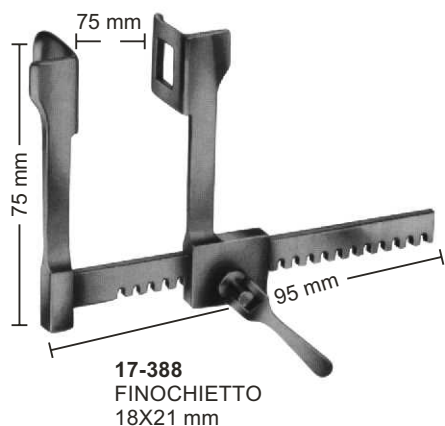

Rib Spreaders

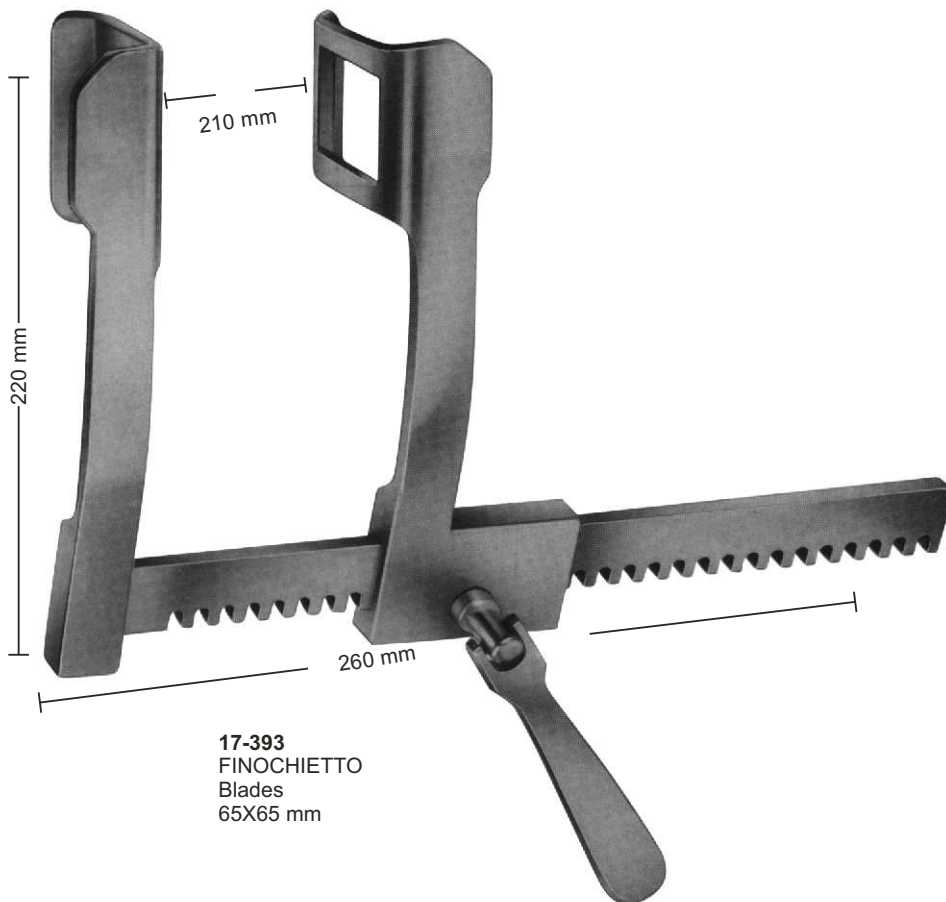
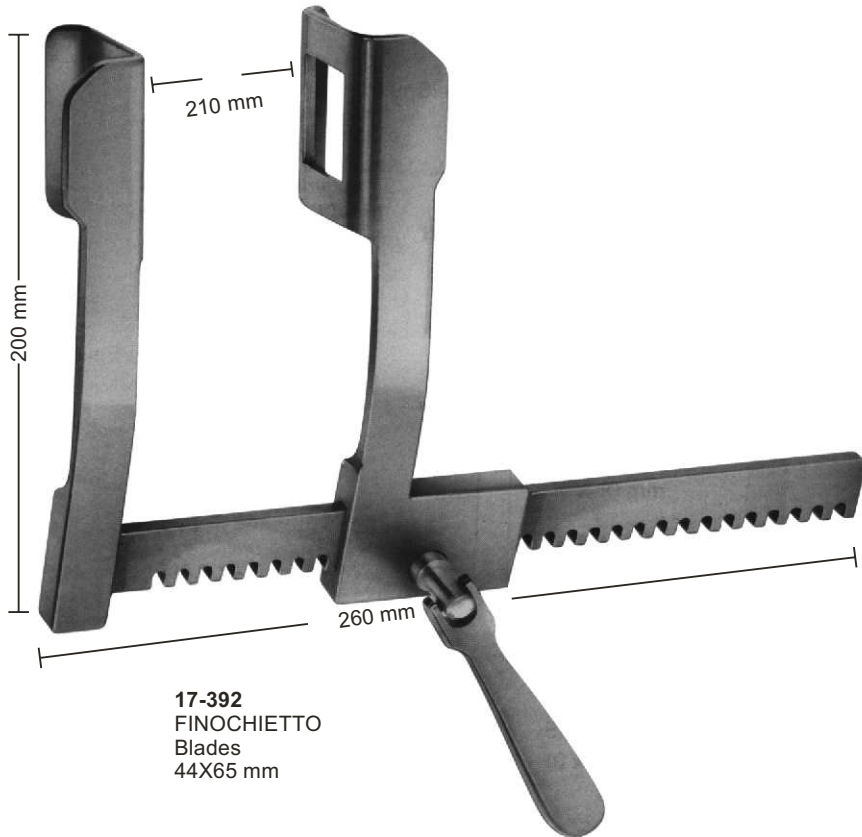

Rib Spreaders

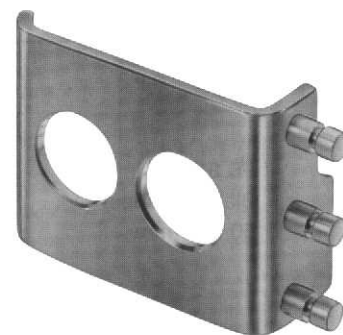
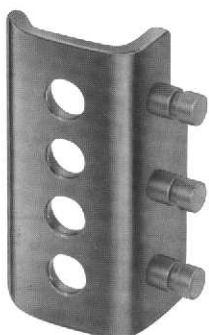

17-395
Blades
46x67 mm

17-397
Blades
46x67 mm

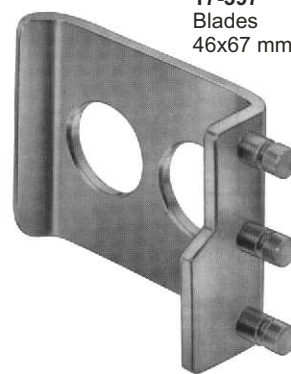
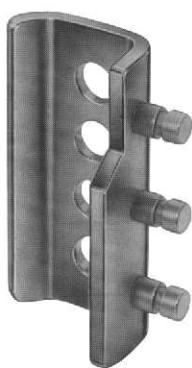

17-396
Blades
80x67 mm

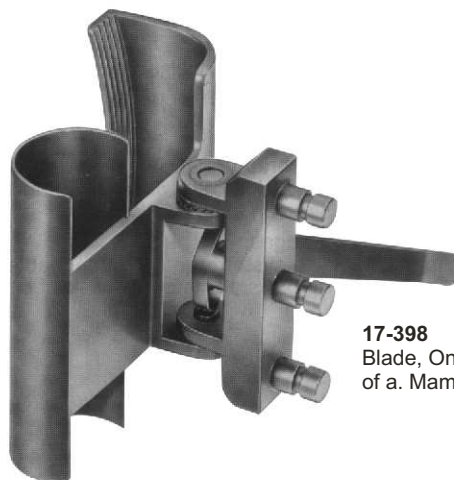
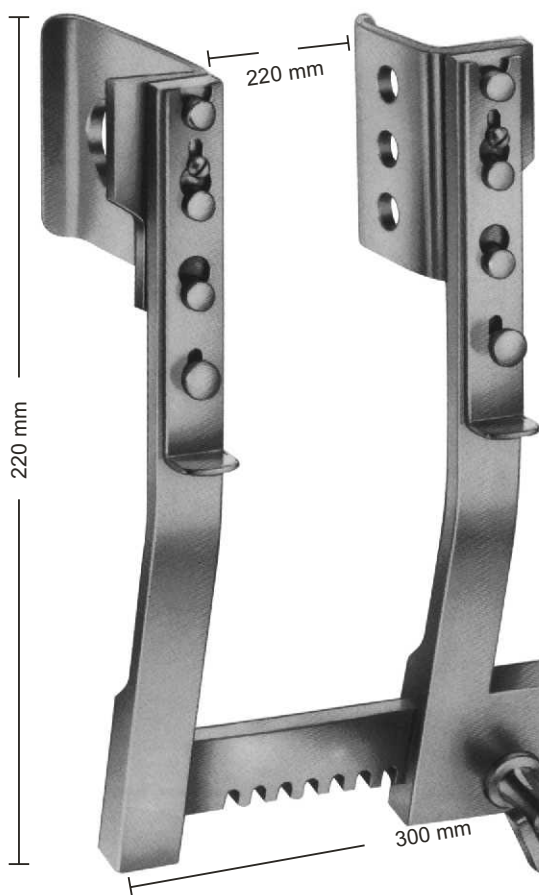

17-398
Blade, Only, for preparation
of a. Mammaria, 25.5x80mm

17-394
FINOCHIETTO-BURFORD
with 2 pairs of blades

Rib Spreaders

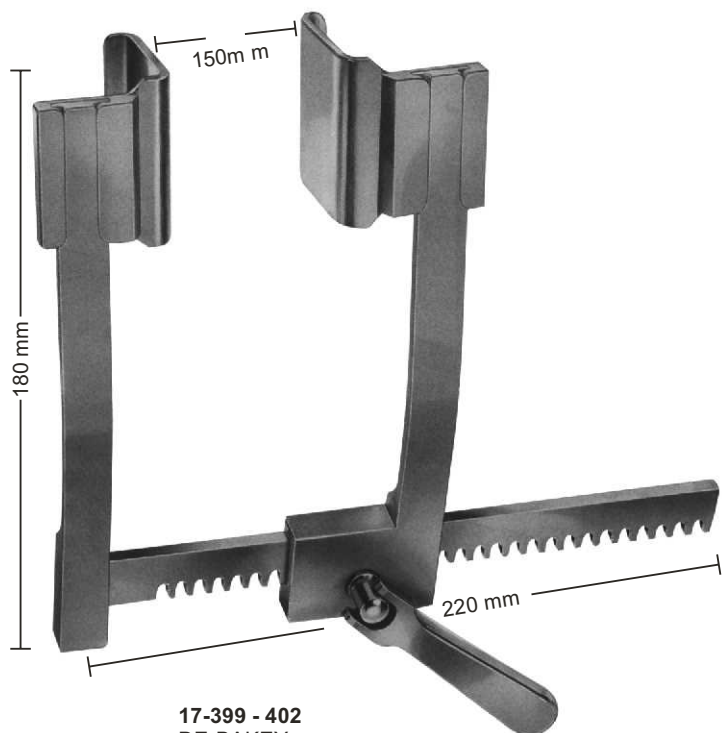

17-399 - 402
DE-BAKEY
with 3 pairs of blades

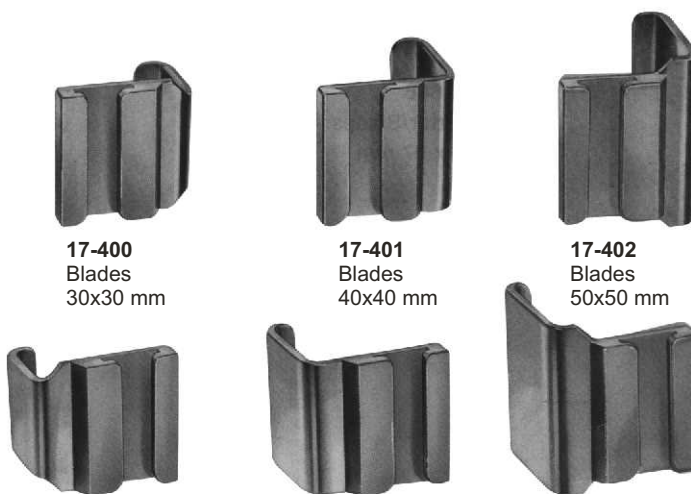

17-400
Blades
30x30 mm

17-401
Blades
40x40 mm

17-402
Blades
50x50 mm

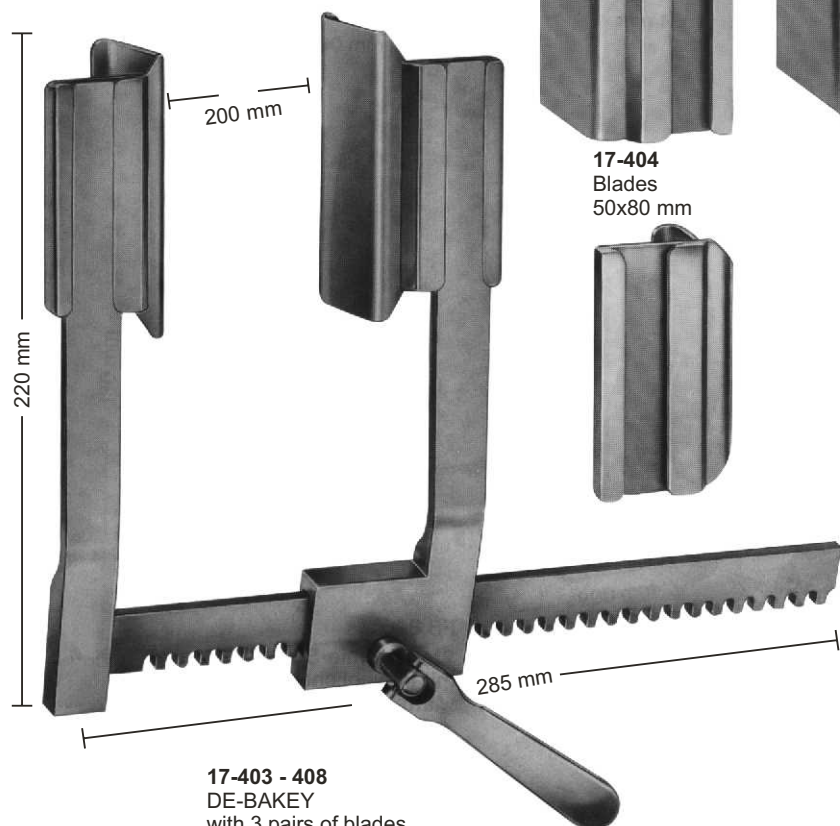

17-403 - 408
DE-BAKEY
with 3 pairs of blades

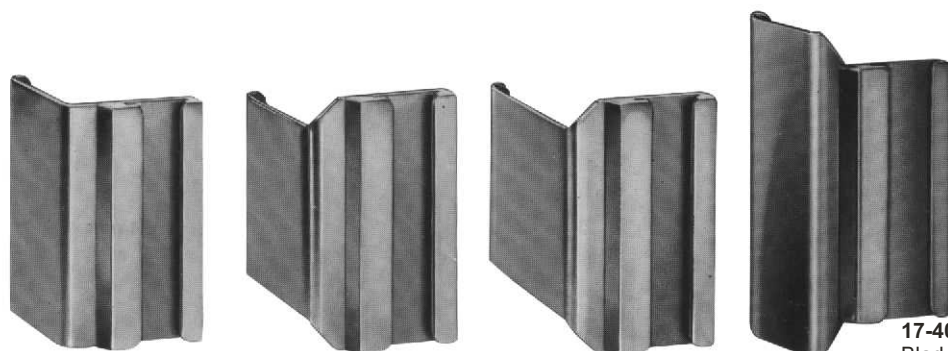

17-404
Blades
50x80 mm

17-405
Blades
80x60 mm

17-406
Blades
50x80 mm

17-407
Blades
40x100 mm

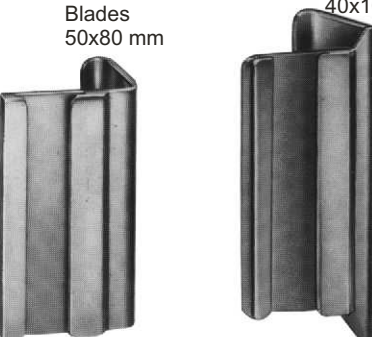

17-408
Sternotomy Blades
50x660 mm

Sternotomy Spreaders

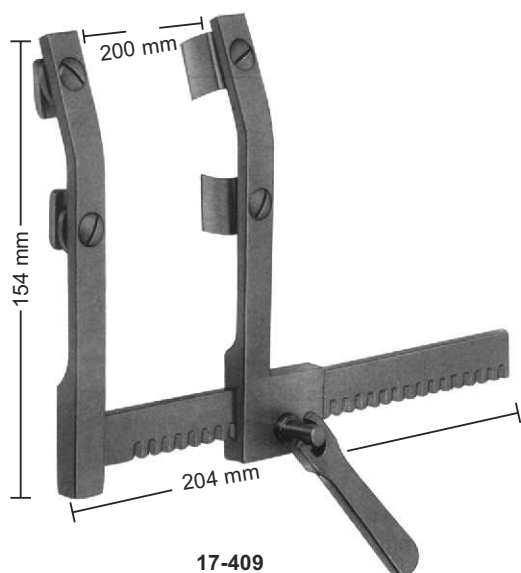

17-409
MORSE
Sternotomy spreader
for children, with moveable
double, each blade
12x20 mm

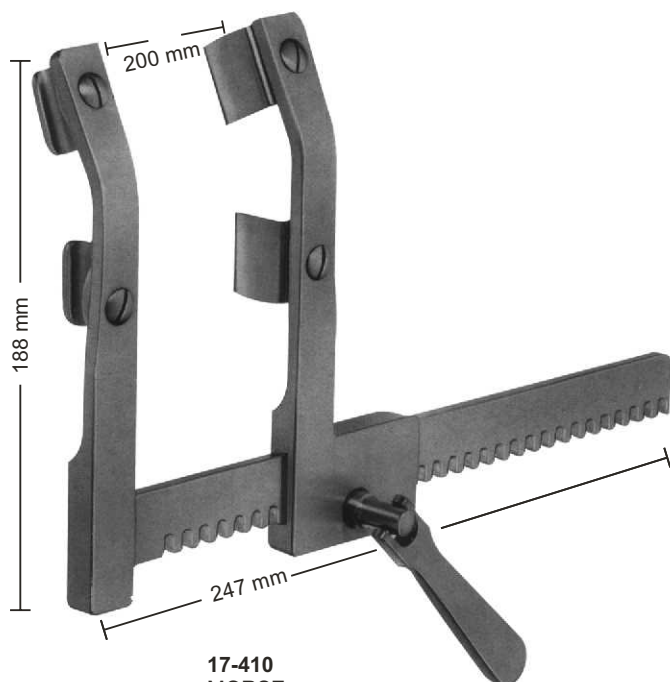

17-410
MORSE
Sternotomy spreader
for adults, with moveable
double, each blade
19x19 mm

Sternotomy- Spreaders

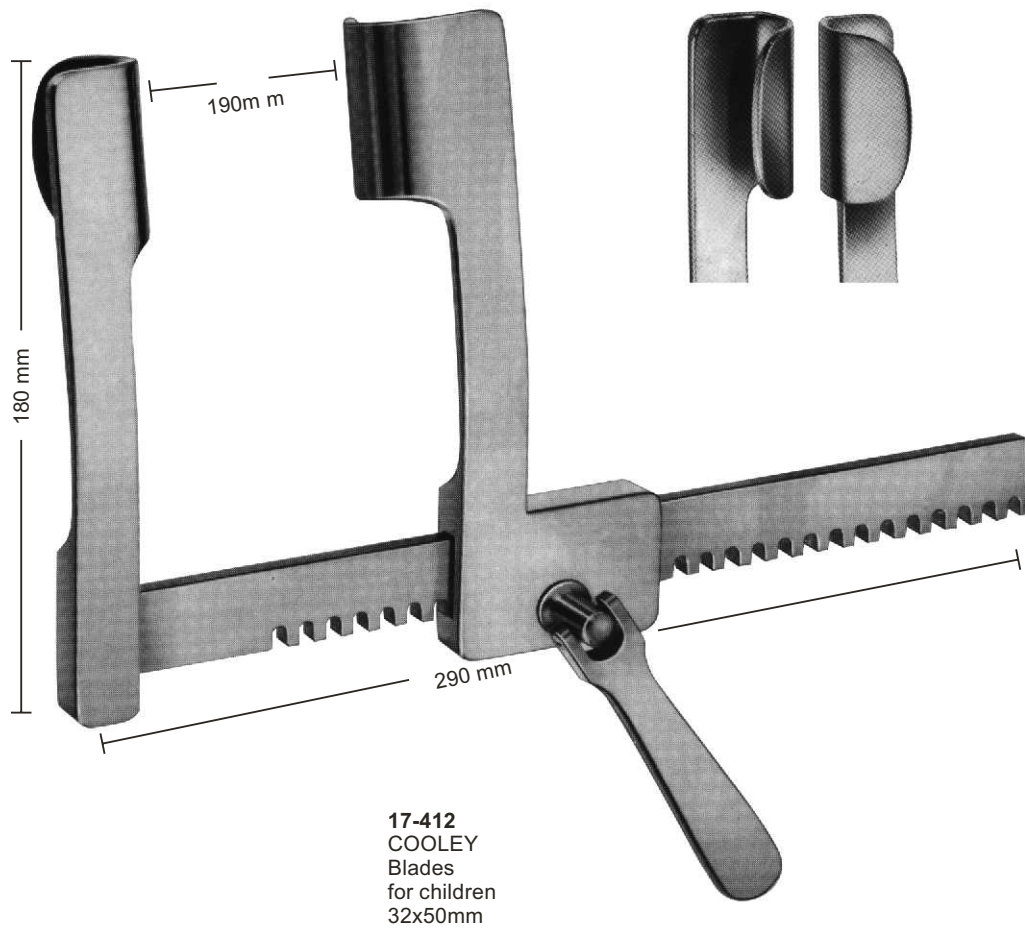
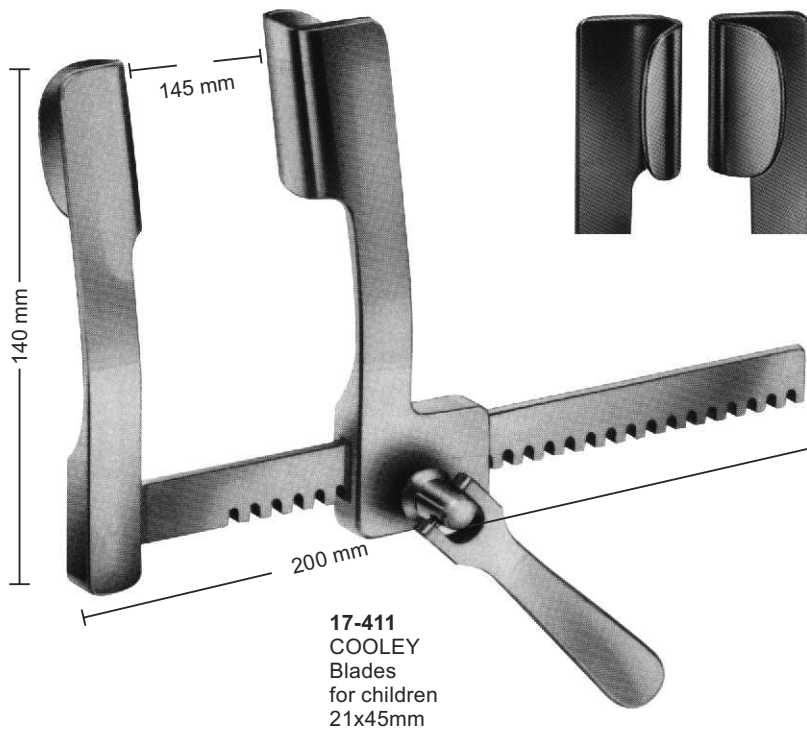

Thoracic Retractors



17-414
Blades
75x75 mm



17-415
Blades
42x65 mm

Blades with Ball Snap System
Delivery: in Pairs

- 17-413 - 415**
Thoraxsperrer (Mercedes-Sperrer)
complete consisting of:
17-413 Retractor only
17-414 1 Pair of blades 42x65 mm
17-415 1 Pair of blades 75x75 mm

Rib Spreaders-and Contractors



1/2

17-416
SELLORS
Rib spreader-and contractor
with swivel blades
200 mm



1/2

17-417
BAILEY
150 mm

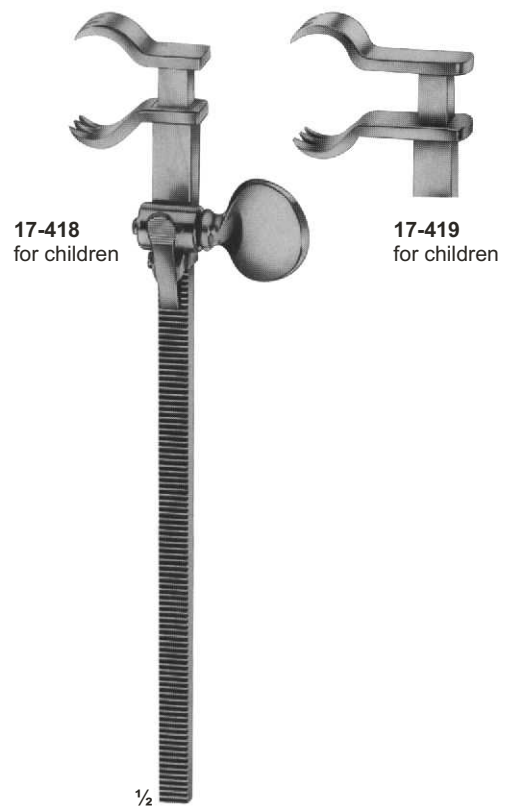

17-418
for children

17-419
for children

1/2

17-418 - 419
BAILEY
200 mm

Rib Spreaders-and Contractors

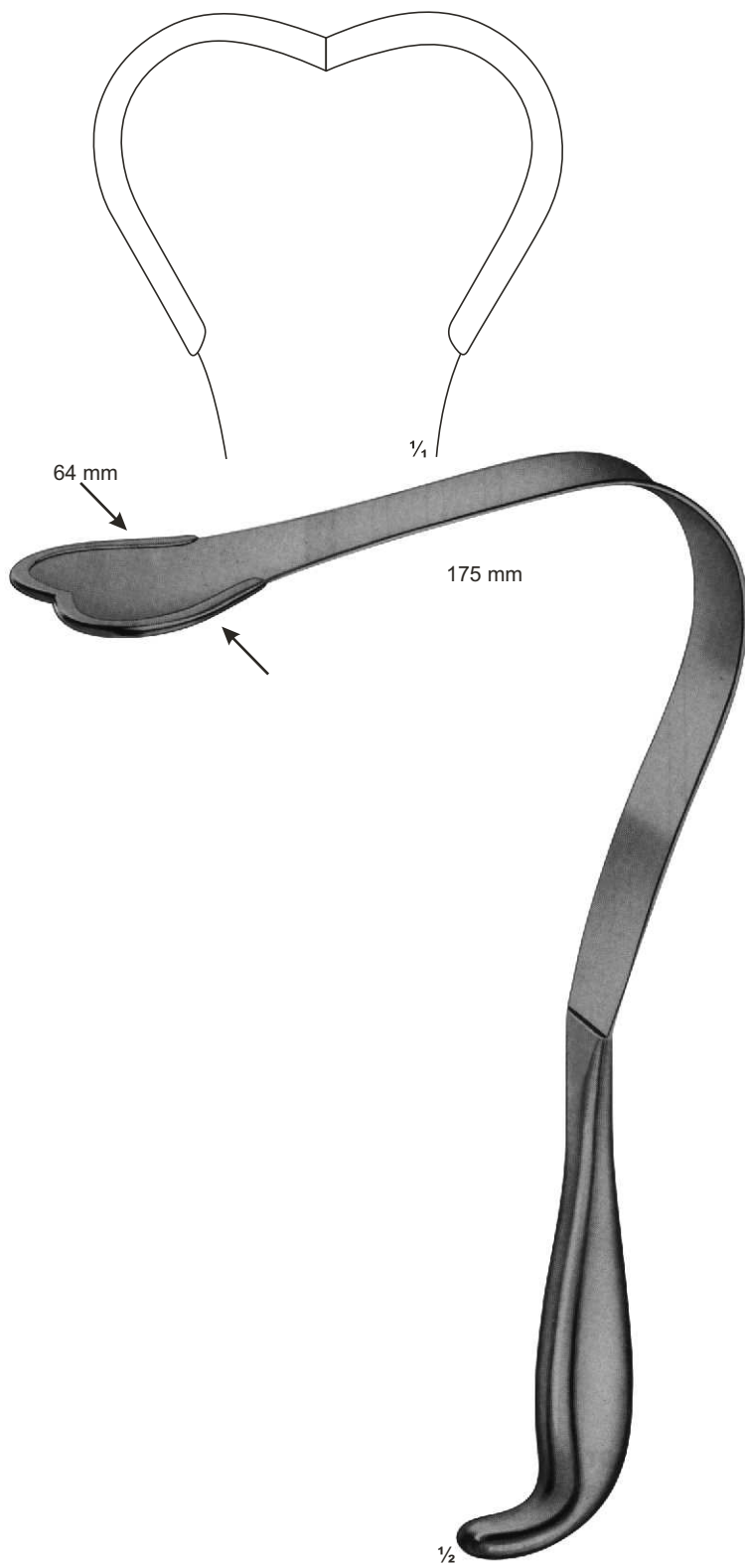

17-420
HARRINGTON-PEMBERTON
federnd/flexible
295 mm

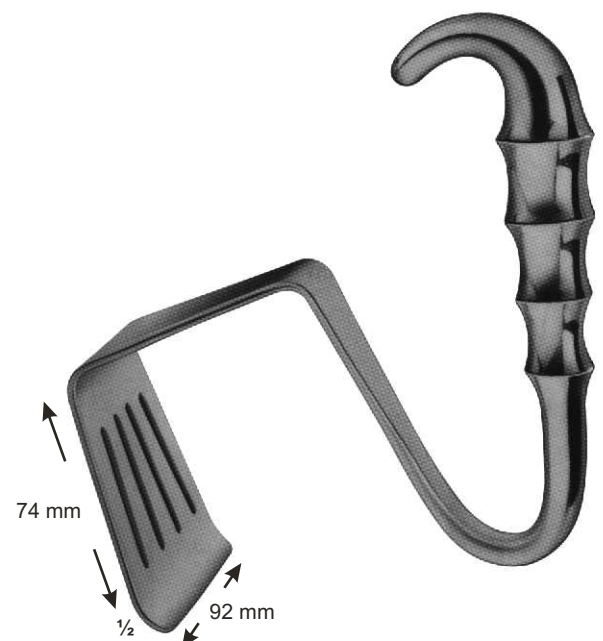

17-421
DAVIDSON
Scalpel haken

Rib Spreaders-and Contractors



17-422
ALLISON
255 mm



17-423
ALLISON
320 mm



ϕ 6-10 mm
1/2

17-424
DE BAKEY
With central bore,
3.0mm diam.
with lateral slots
275 mm



ϕ 7-9 mm
1/2

17-425
YANKAUER
With central bore,
2.0mm diam.
285 mm

Punches

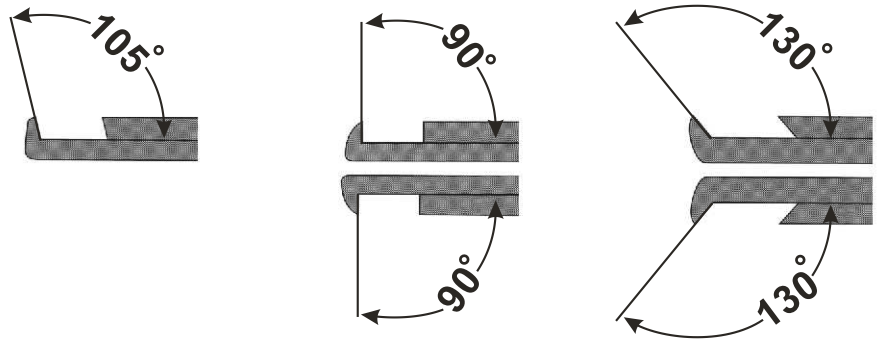

90° upwards cutting

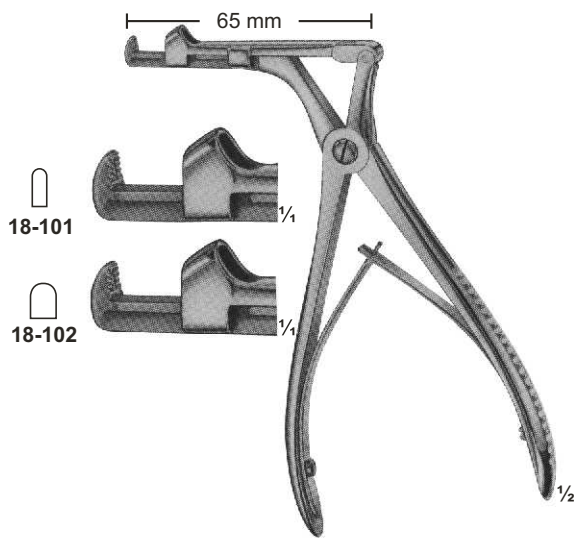

18-101 - 102
CITELLI
2 mm, 3,5 mm

90° upwards cutting

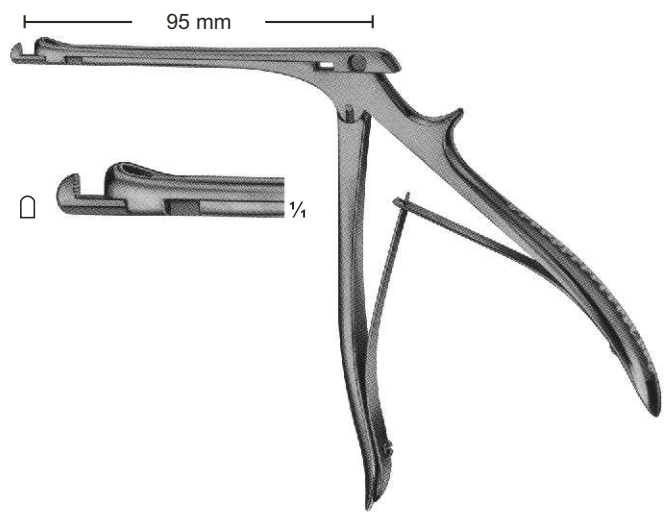

18-103
CITELLI- BEYER
1,8 mm

Punches

90° upwards cutting

85 mm

18-104
4 mm



18-105
5 mm

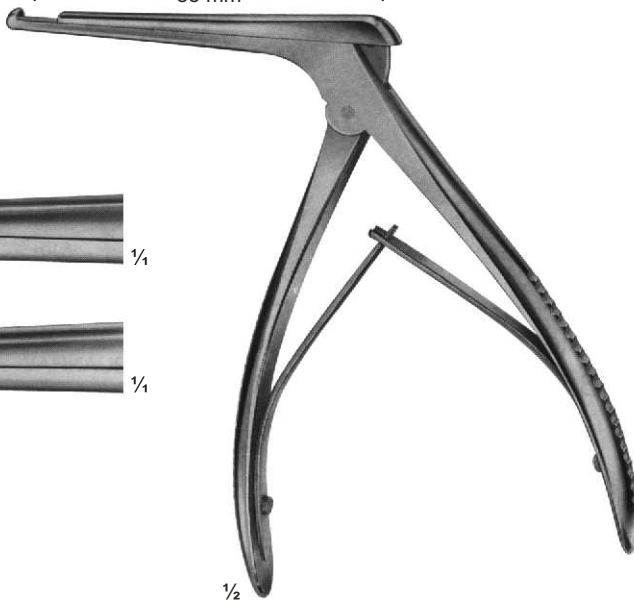

18-104 - 105
KERRISON

90° upwards cutting

140 mm

18-106
3,3 mm



18-107
4,0 mm

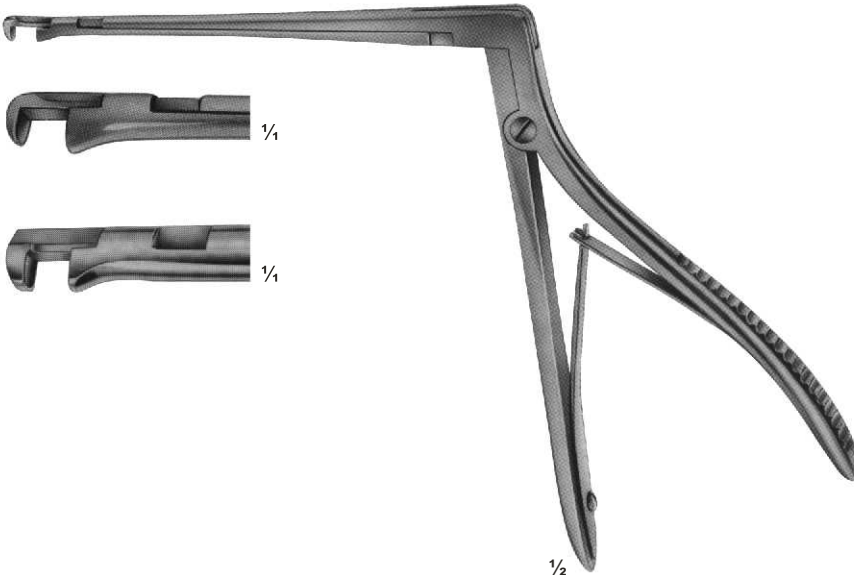
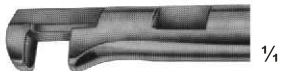

18-106 - 107
HAJEK-KOFLER

Punches

130° upwards cutting

18-108
1 mm □

18-109
2 mm □

18-110
3 mm □

18-111
4 mm □

18-112
5 mm □

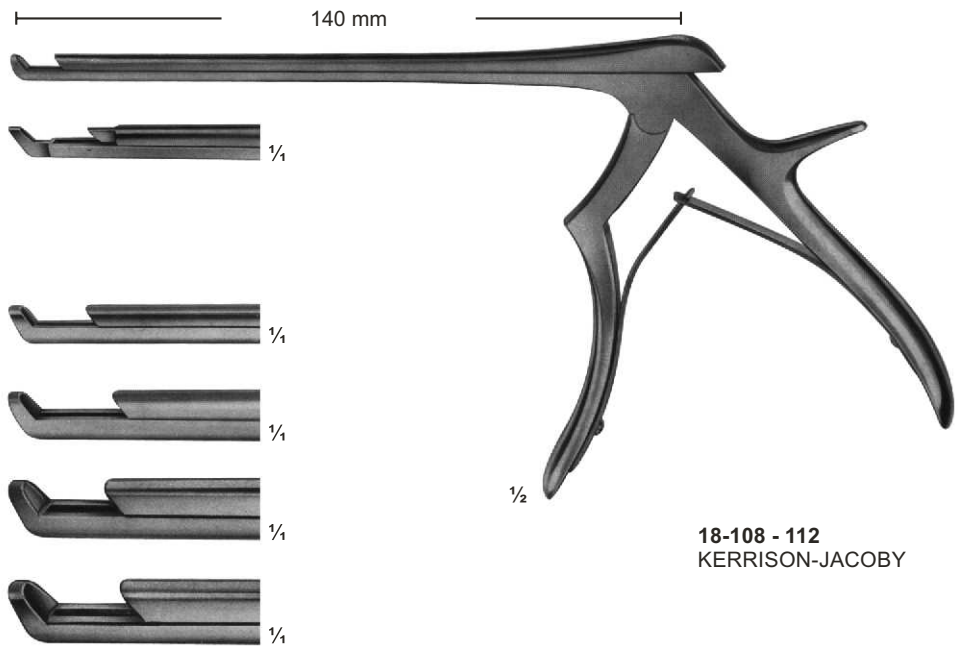

18-108 - 112
KERRISON-JACOBY

90° upwards cutting

18-113
1 mm □

18-114
2 mm □

FERRIS-SMITH-KERRISON

18-115
3 mm □

18-116
4 mm □

18-117
5 mm □

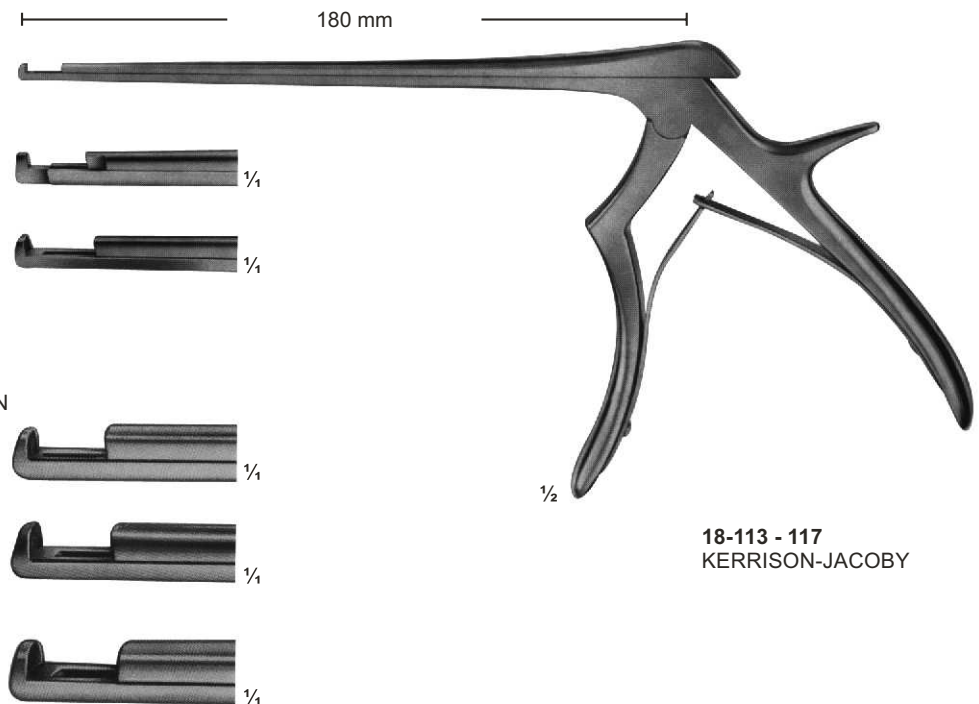

18-113 - 117
KERRISON-JACOBY

Rongeurs

Angled positions for rongeurs

18-118
3,0 mm

18-119
3,6 mm

18-120
4,2 mm

18-121
4,8 mm

18-122
5,8 mm

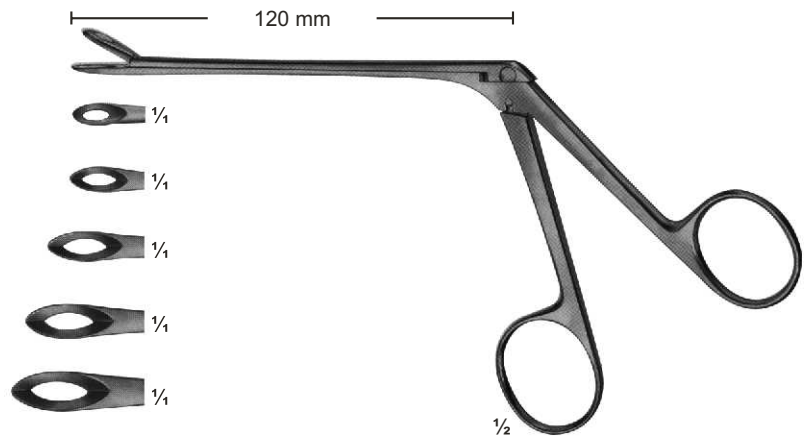

18-118 - 122
WEIL-BLAKESLEY

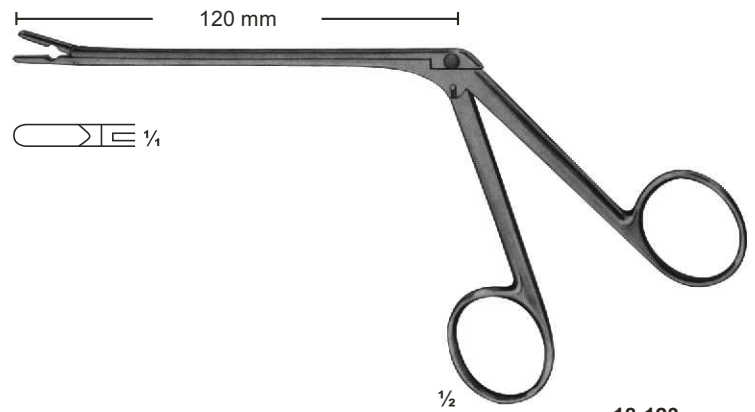

18-123
TAKAHASHI
3 mm

130°

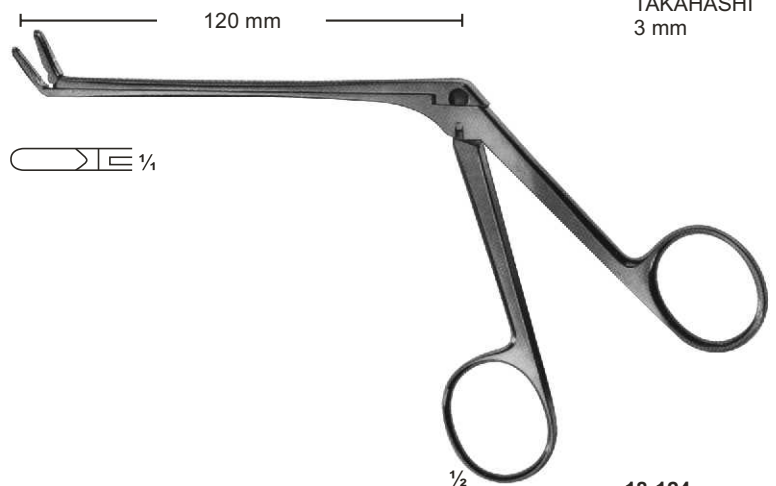

18-124
TAKAHASHI
3 mm

Rongeurs

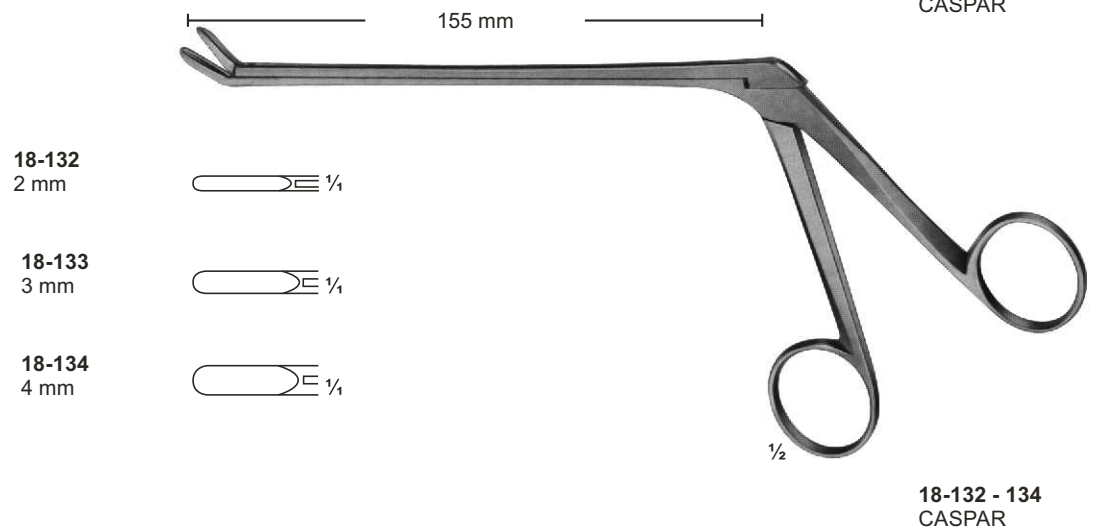
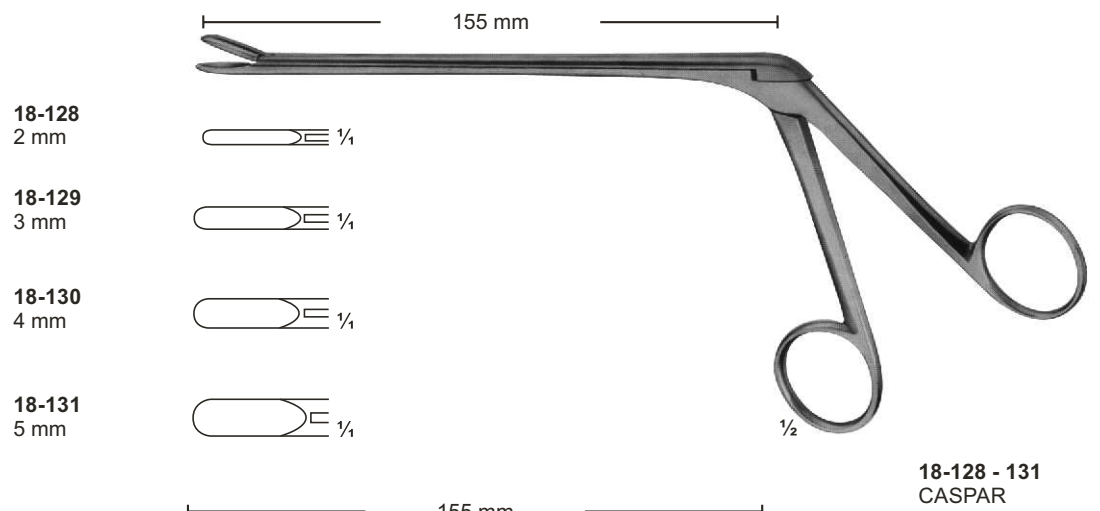
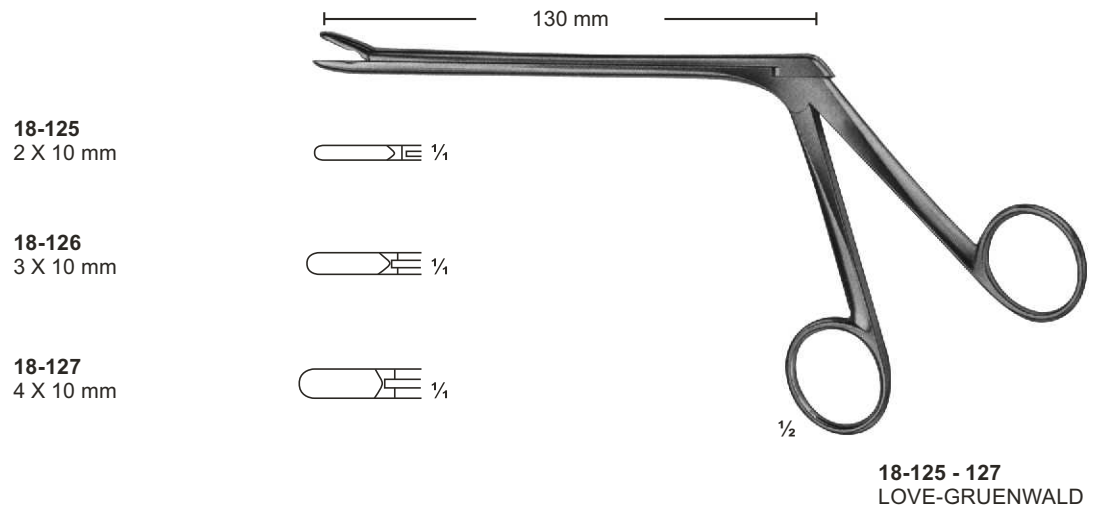

Rongeurs

18-135
2 mm

18-136
3 mm

18-137
4 mm

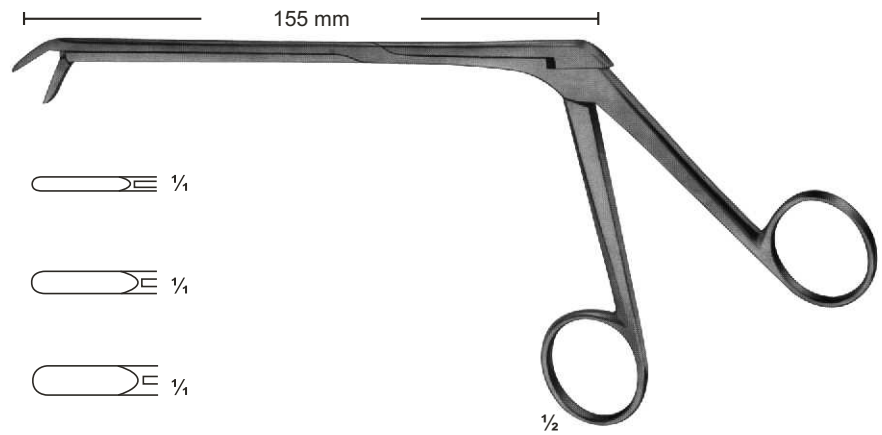

18-135 - 137
CASPAR

Length of shaft 140 mm	Length of shaft 160 mm	Length of shaft 185 mm	size of jaws
18-138	18-143	18-148	2 X12 mm
18-139	18-144	18-149	3 X12 mm
18-140	18-145	18-150	4 X14 mm
18-141	18-146	18-151	5 X14 mm
18-142	18-147	18-152	6 X16 mm

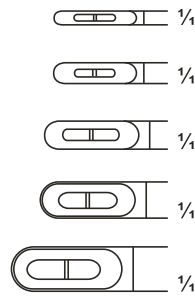

18-138 - 152
CASPAR

Length of shaft 140 mm	Length of shaft 160 mm	Length of shaft 185 mm	size of jaws
18-153	18-156	18-159	3 X12 mm
18-154	18-157	18-160	4 X14 mm
18-155	18-158	18-161	5 X14 mm

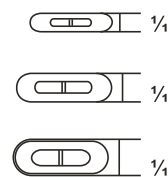

18-153 - 161
CASPAR

Rongeurs

Length of shaft 140 mm	Length of shaft 160 mm	Length of shaft 185 mm	size of jaws
18-162	18-164	185-166	3 X12 mm
18-163	18-165	18-167	4 X14 mm

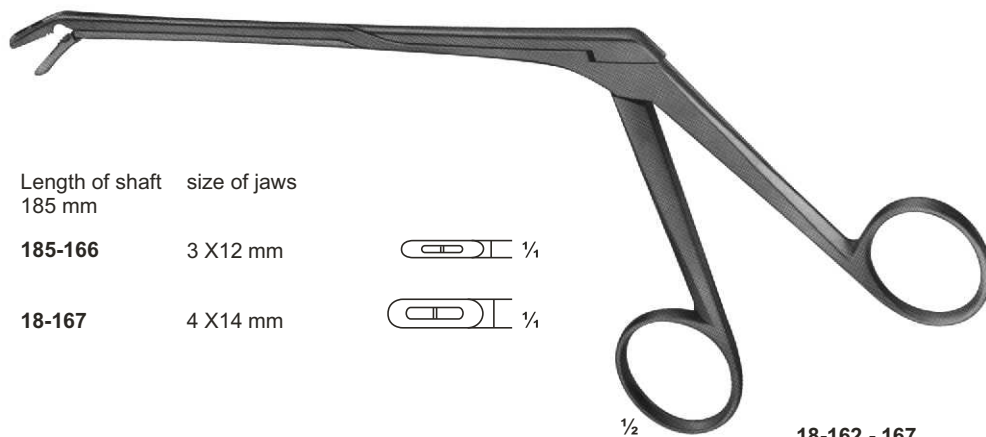

18-162 - 167
GUSHING

18-168
2 X 10 mm
GUSHING

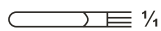

18-169
3 X 10 mm
LOVE-GRUENWALD

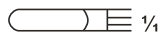

18-170
4 X 10 mm
SPURLING

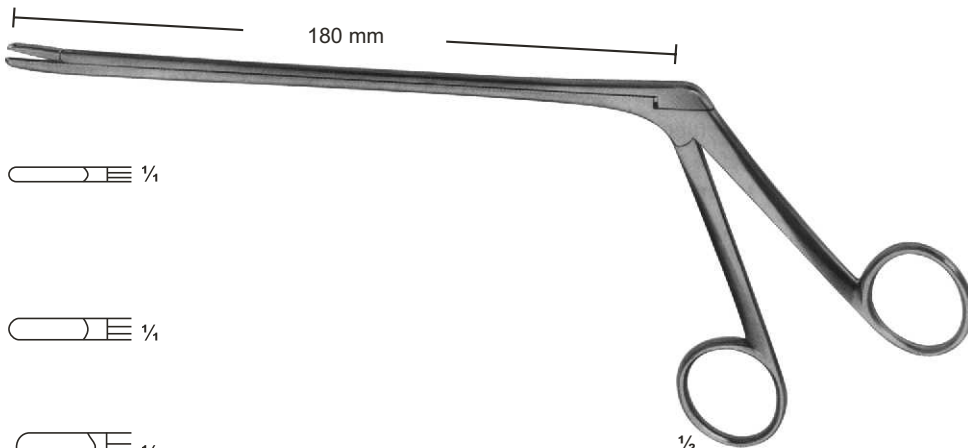
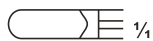

18-168 - 170
LOVE-GRUENWALD

18-171
3 X 10 mm
LOVE-GRUENWALD



18-172
4 X 10 mm
SPURLING

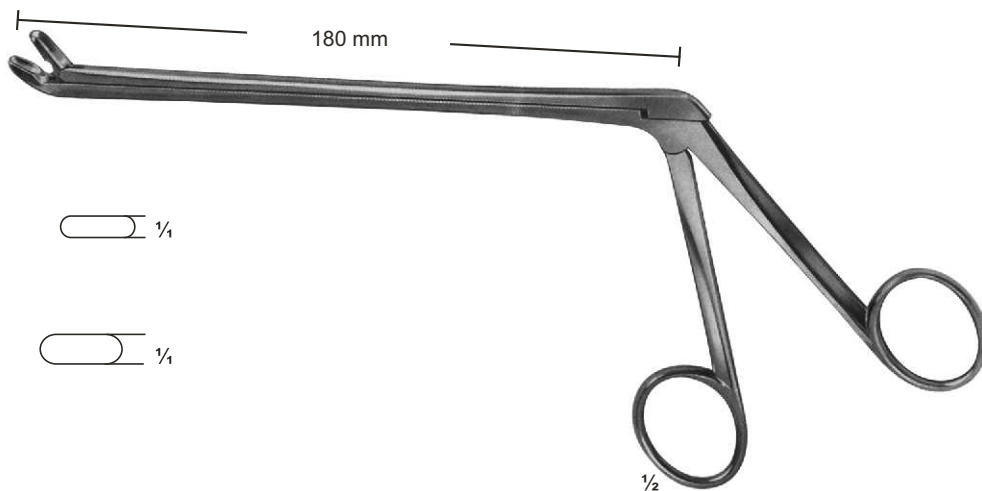

18-171 - 172
LOVE-GRUENWALD

Rongeurs

18-173
3 X 10 mm
LOVE-GRUENWALD

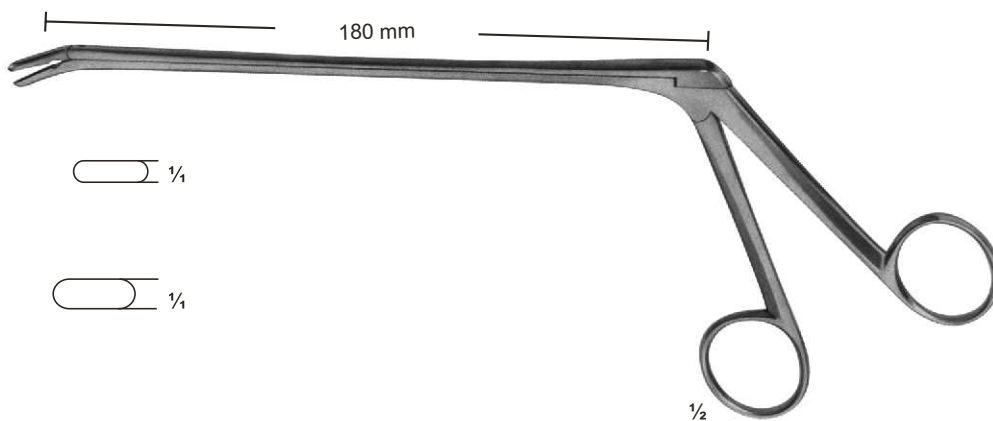

18-174
4 X 10 mm
SPURLING



18-173 - 174
LOVE-GRUENWALD

18-175
7 mm

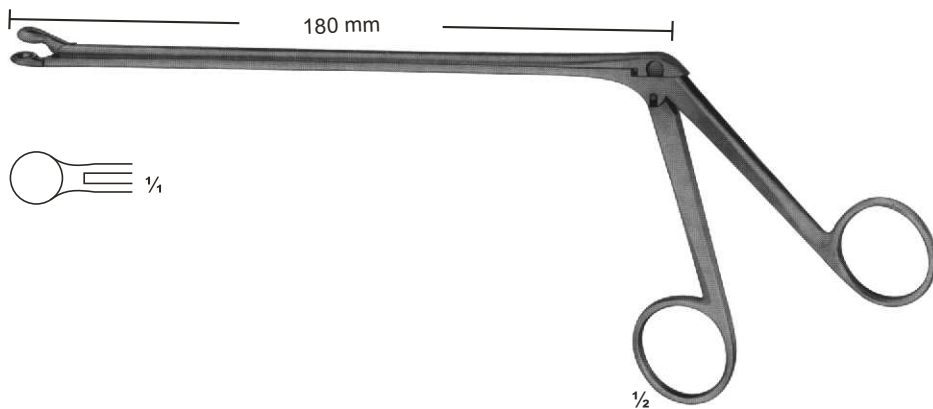

18-175
OLDBERG

18-176
YASARGIL
2,2 mm



18-177
YASARGIL
3,5 mm



18-176 - 177

Rongeurs

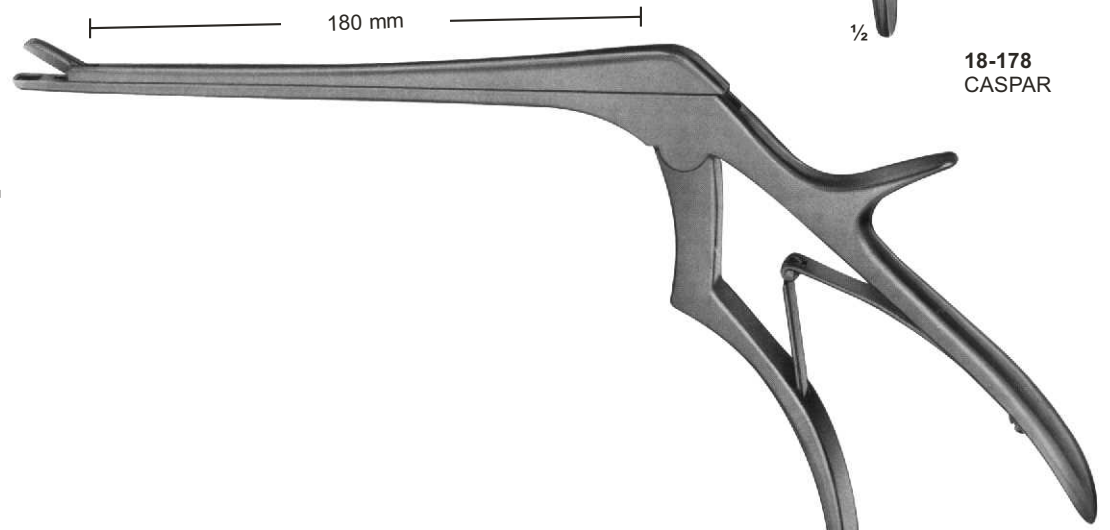
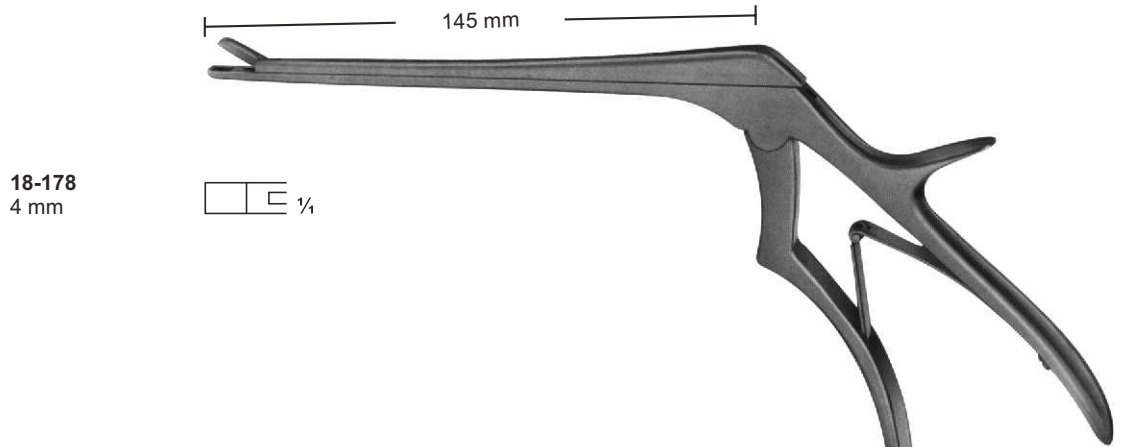

18-179
4 mm

$\square \text{E} \frac{1}{4}$

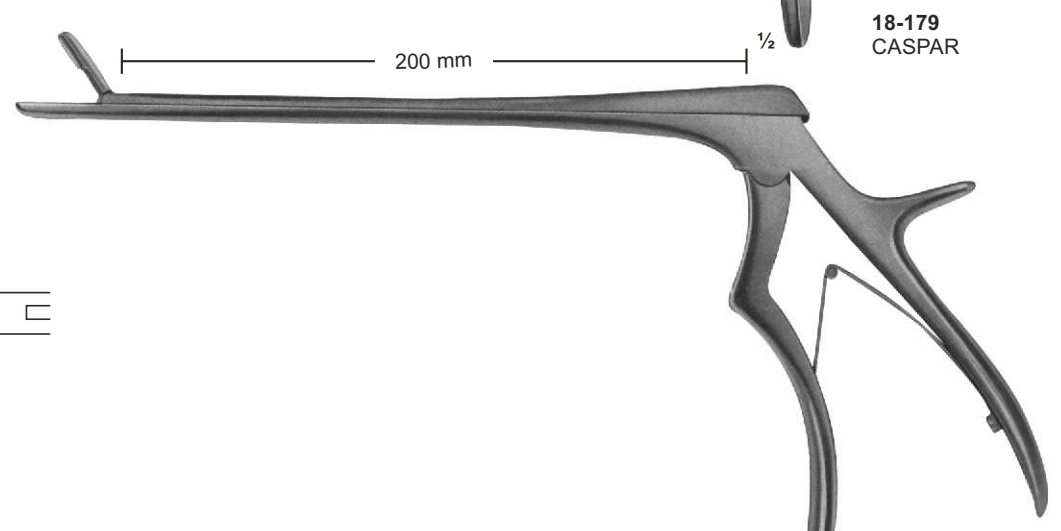

18-180
5,5 mm

$\text{O} \text{E}$

18-180
WAGNER

$\frac{1}{2}$

Amputation

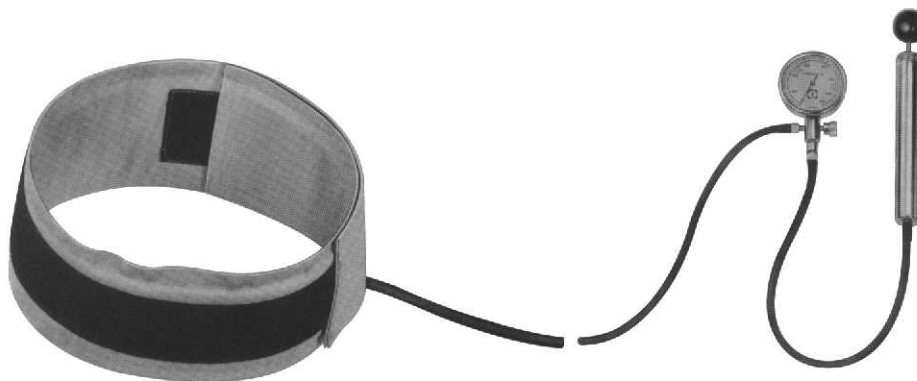

19-101
Comprimeter. Compression apparatus for producing exsanguination in the extremities. Manometer registers up to 600 mm Hg. Complete, consisting of:
19-101 2 Pump with manometer
19-102 3 Cuff for the leg
19-103 14 Cuff for the upper arm

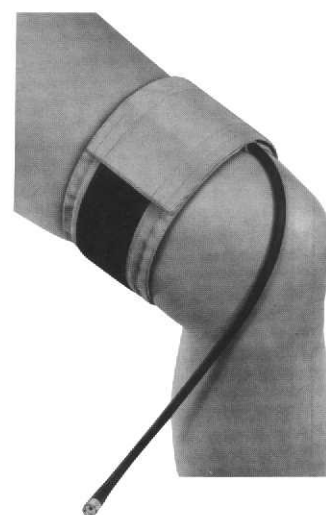
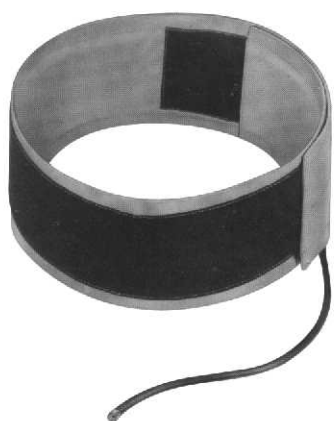

19-104 3 Cuff for the leg
19-105 4 Cuff for the lower arm
19-106 5 Cuff for children
19-107 14 Cuff for the upper arm

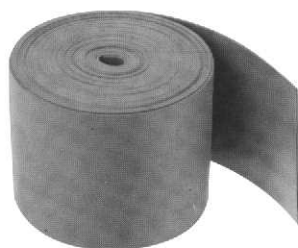

19-108
ESMARCH
Staubinde
Compression bandage
5 m lang/long
6 cm breit/wide



19-109
ESMARCH
Stauschlauch
Compression tube
1 m lang/long

Amputation and Resection Knives



19-110
Length of blades
Phalangeal knife
105 mm



19-111
Length of blades
Interosseous knife
110 mm



19-112
Length of blades
Periosteum knife
with raspatory
65 mm



19-113 - 114
LANGENBECK
Length of blades
Resection knives
55 mm



19-113

19-114

Amputation Retractors

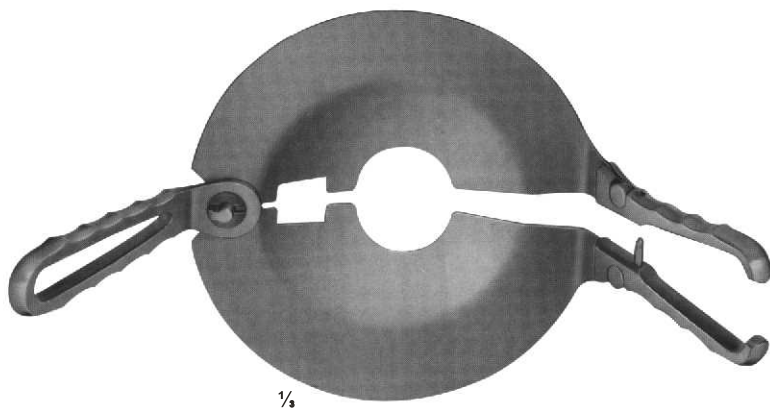

1/3

19-115
PERCY
removeable handles

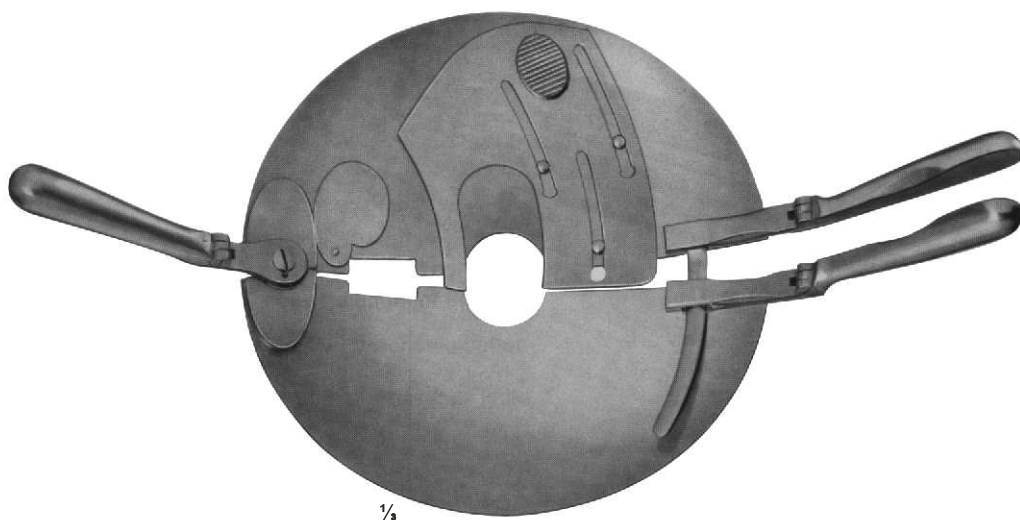

1/3

19-116
PERCY
reversible handles

Amputation Saws



$\frac{1}{4}$
19-117
 CHARRIEER
 Length of blade
 215 mm
 complete with one saw
 blade each
 350 mm
 Spare saw blades, carbon steel
19-118 12 mm
19-119 20 mm

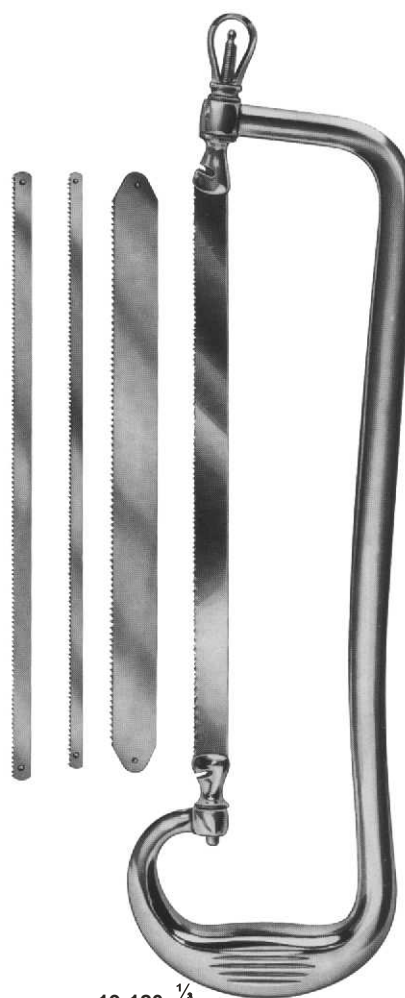

$\frac{1}{4}$
19-120
 RUST
 Length of blade
 235 mm
 complete with one saw
 blade each
 390 mm
19-121 Bow only
 Spare saw blades, carbon steel
19-122 6 mm
19-123 8 mm
19-124 12 mm
19-125 20 mm

Amputation Saws

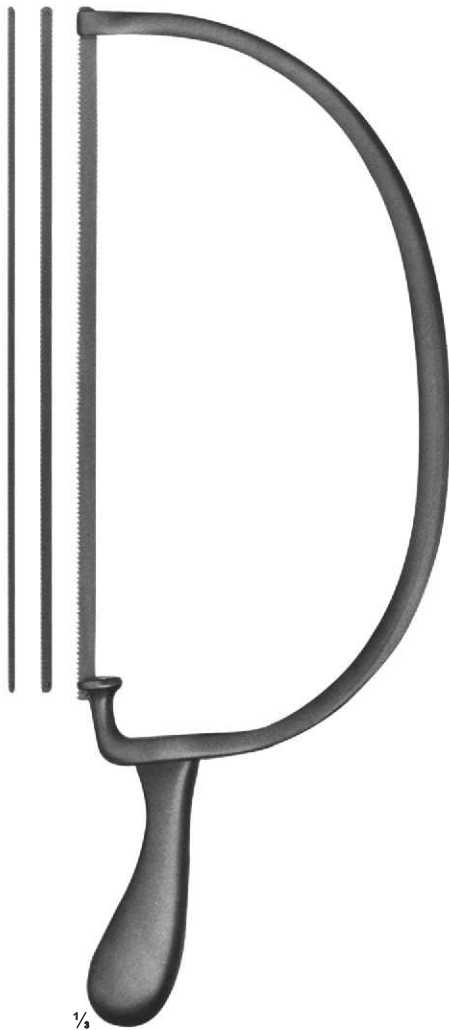

1/3

19-126
BIER
 Length of blade
 270 mm
 complete with one saw
 blade each
 420 mm
 Spare saw blades, carbon steel
19-127 4 mm
19-128 6 mm
19-129 8 mm



1/3

19-130
CHARRIERE
 Length of blade
 180 mm
 Spare saw blades,
 carbon steel
 270 mm

19-131
CHARRIERE
 Length of blade
 240 mm
 Spare saw blades,
 carbon steel
 340 mm



1/3

19-132
SATTERLEE
 Length of blade
 200 mm
 Spare saw blades,
 carbon steel
 290 mm



1/3

19-133
LANGENBACK
 Length of blade
 115 mm
 Metacarpal saw
 235 mm

Wire Saws and Conductor



OLIVECRONA
19-134 300 mm
19-135 400 mm
19-136 500 mm
19-137 700 mm

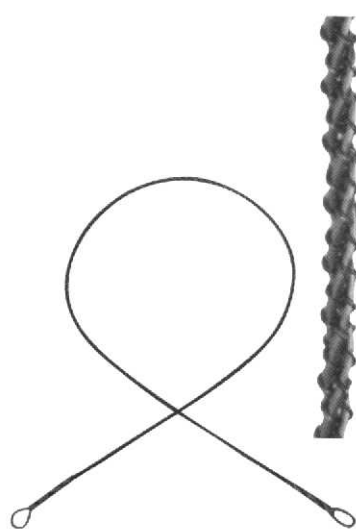

GIGLI
19-138 300 mm
19-139 400 mm
19-140 500 mm
fine, 6 wires twisted
19-141
coars, 4 wires twisted



$\frac{1}{4}$
19-142
GIGLI
Handle



$\frac{1}{2}$
19-143
LEBSCHKE
Conductor for
wire saws, malleable
250 mm

Elevators and Bone Levers

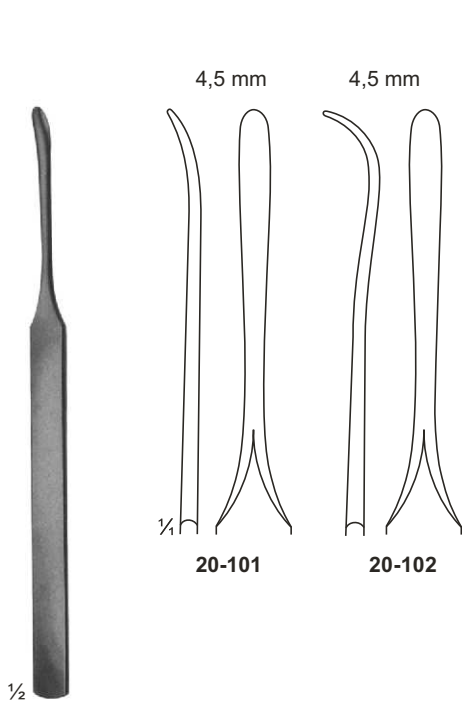

20-101 - 102
KONIG
155 mm

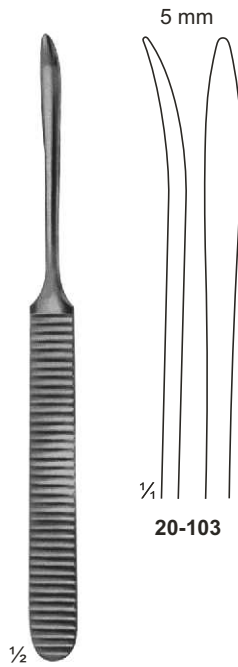

20-103
WILLIGER
165 mm

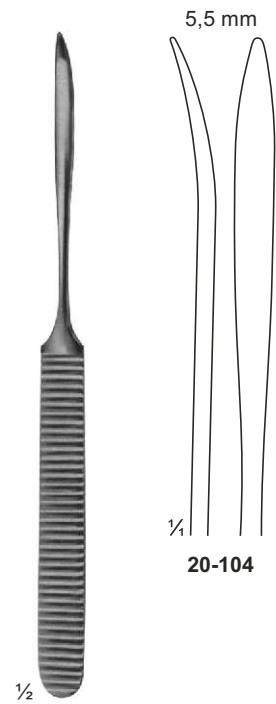

20-104
WILLIGER
170 mm

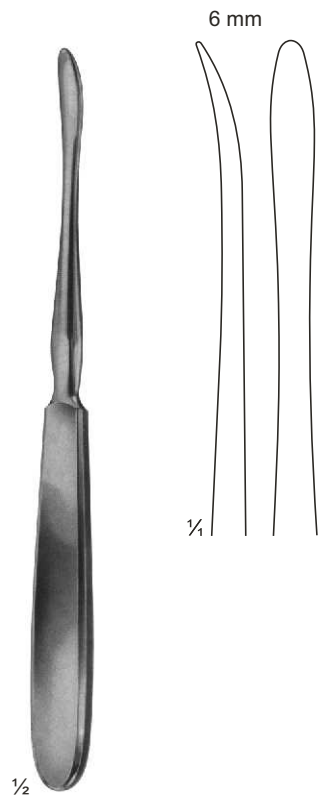

20-105
QUERVAIN
195 mm

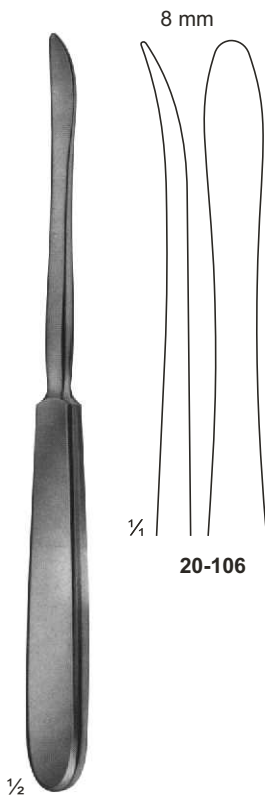

20-106 - 107
LANGENBACK
195 mm

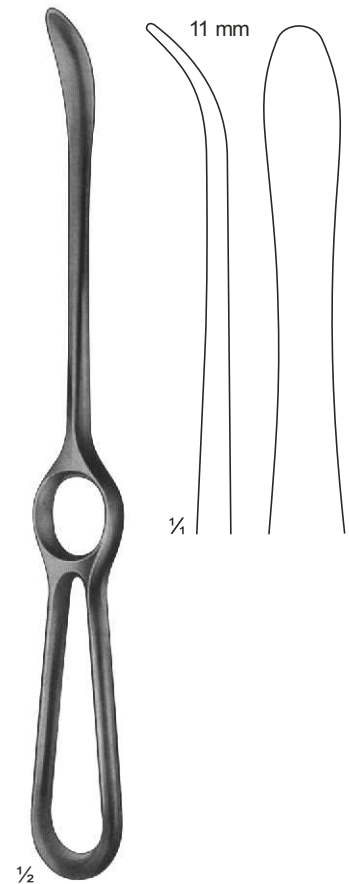

20-108
LANGENBACK
230mm

Bone Levers

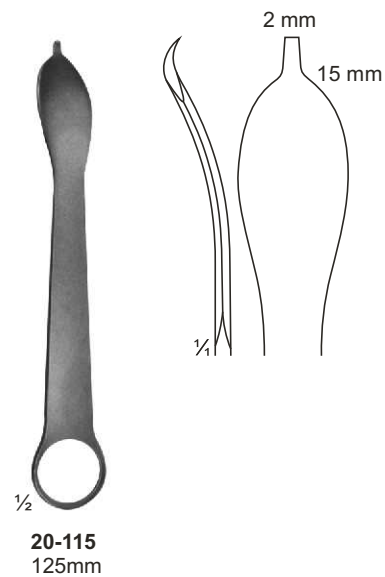
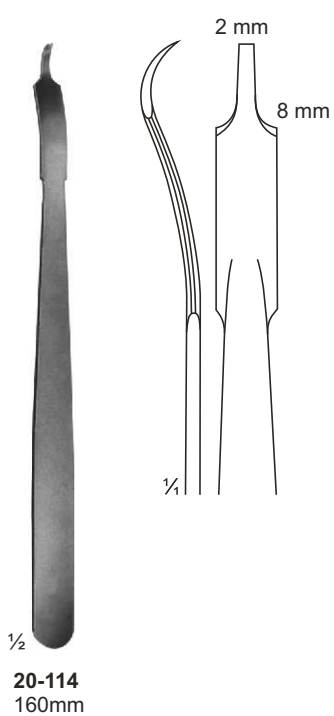
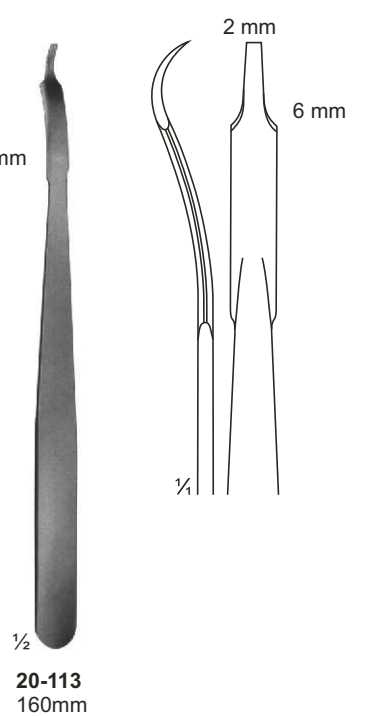
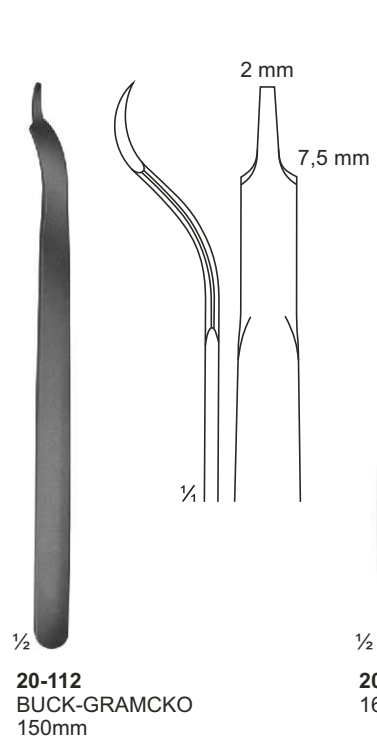
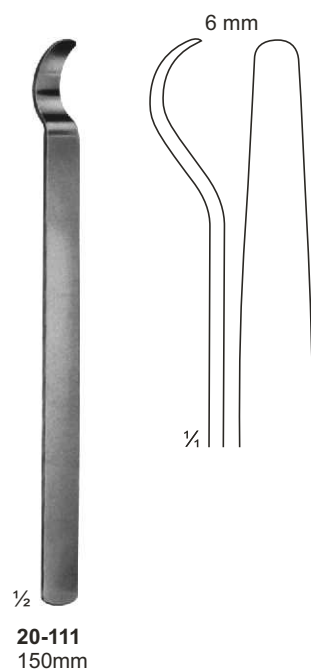
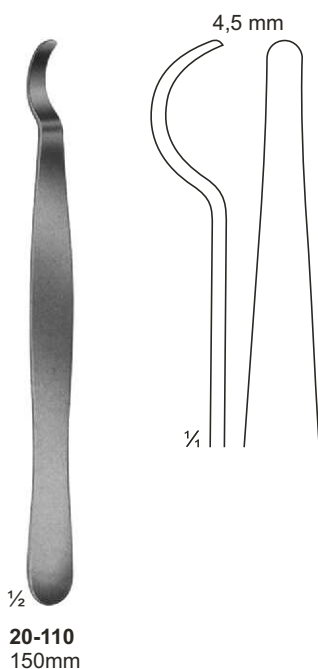
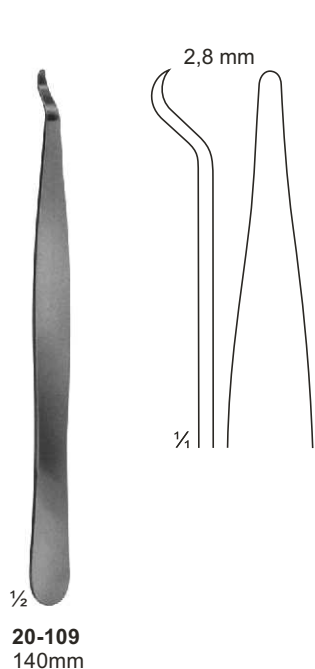

Bone Levers



20-116
LANE TRETHOWAN
215mm

20-117
LANE
255mm

20-118
LANGE-HOHMANN
250mm

20-119 - 120
LANGE-HOHMANN
20-119 265mm
20-120 280mm

Bone Levers



20-121
WAGNER
220 mm

20-122
220 mm

20-123
240 mm

20-124
240 mm

Bone Levers

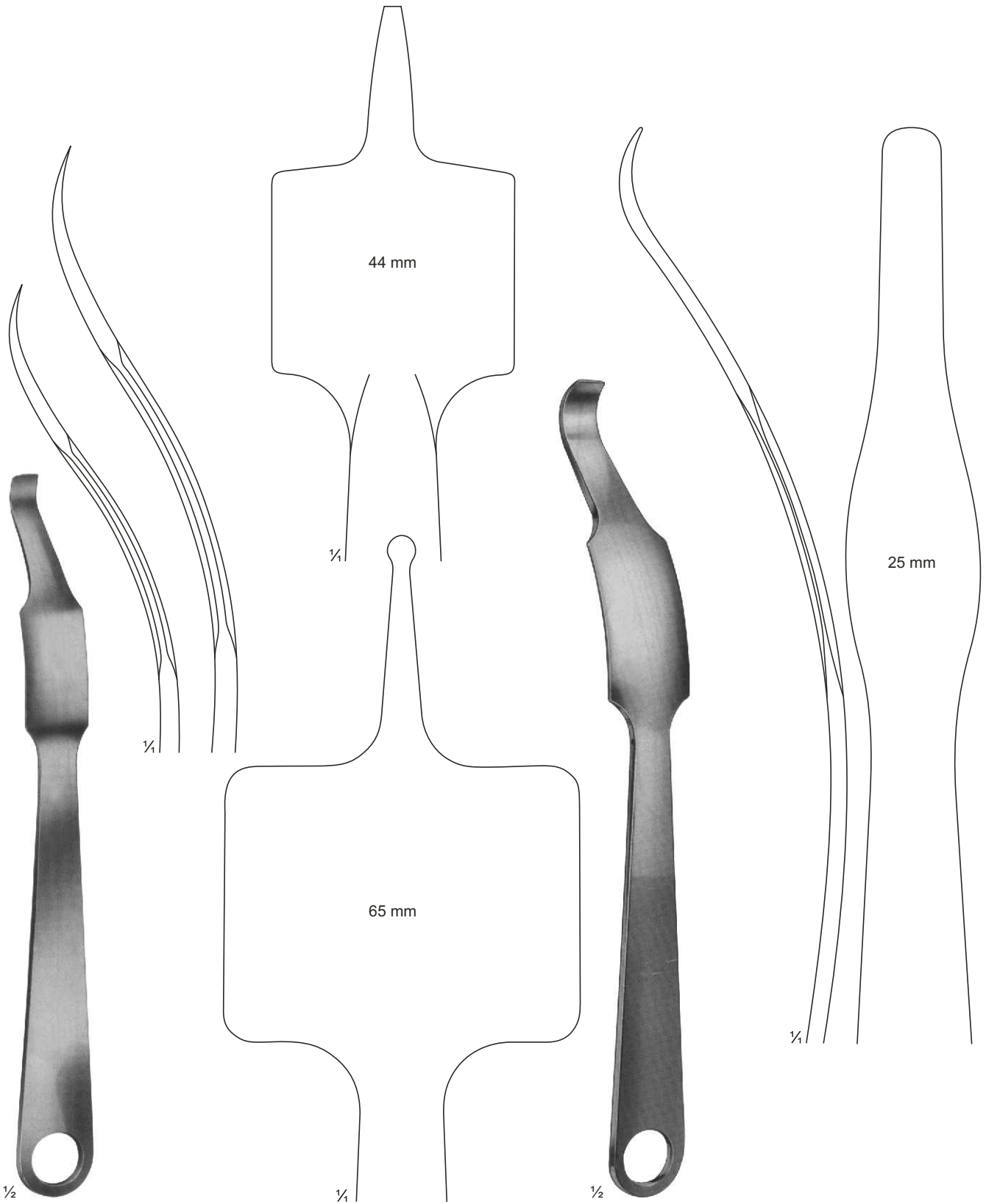

20-125 - 126
 VERBRUGGE-MULLER
 20-125 240 mm
 20-126 255 mm

20-127
 260 mm

Bone Levers

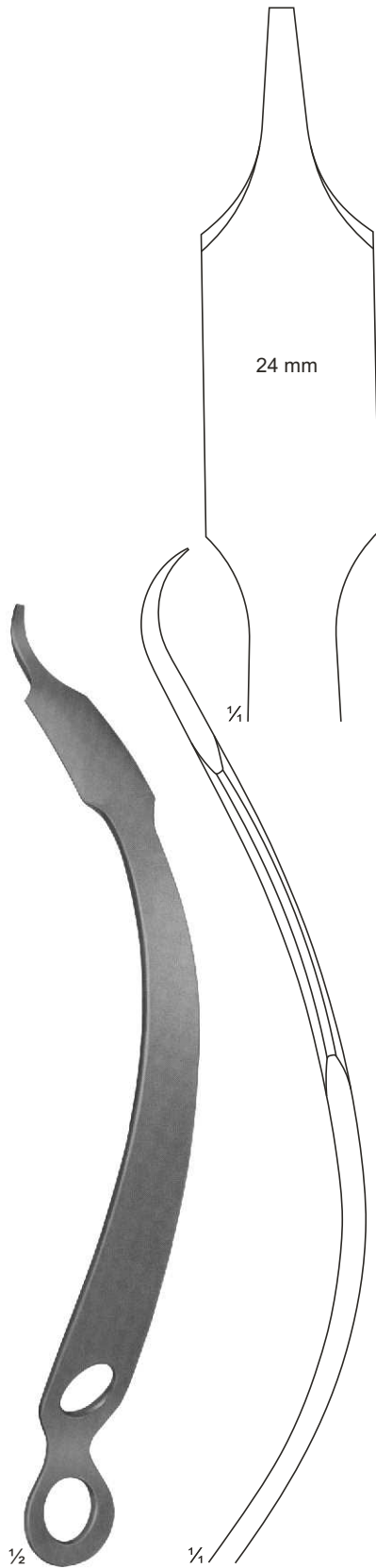

20-128
HOHMANN-ALDINGER
270 mm

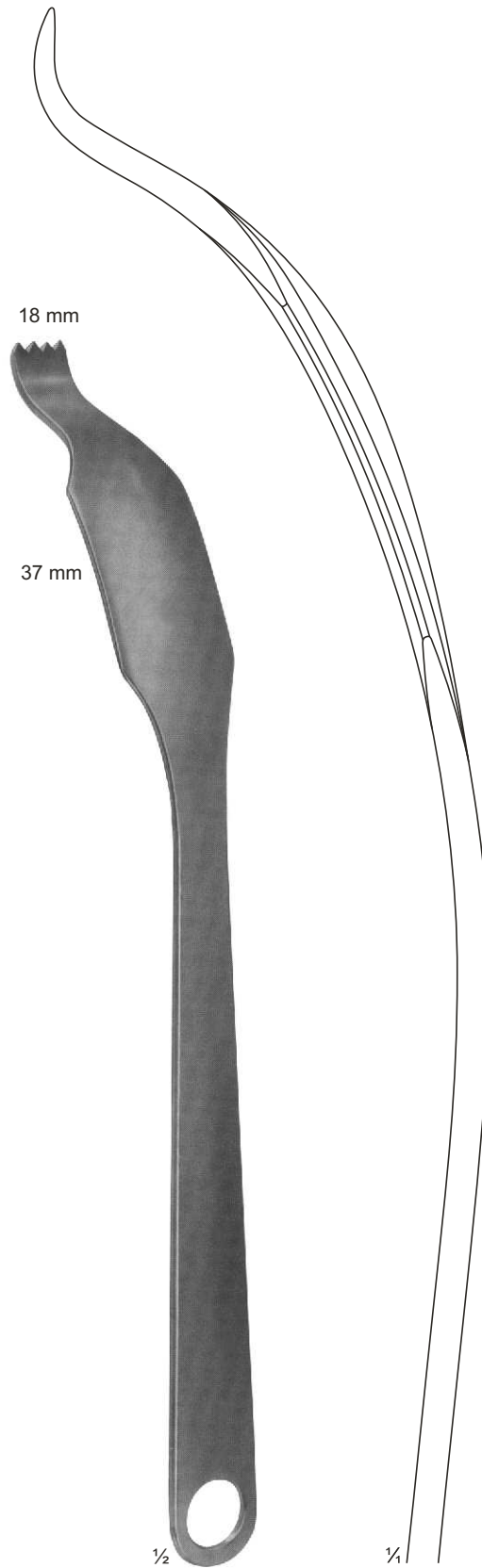

20-129
SCHUMACHER mod. WAGNER
345 mm

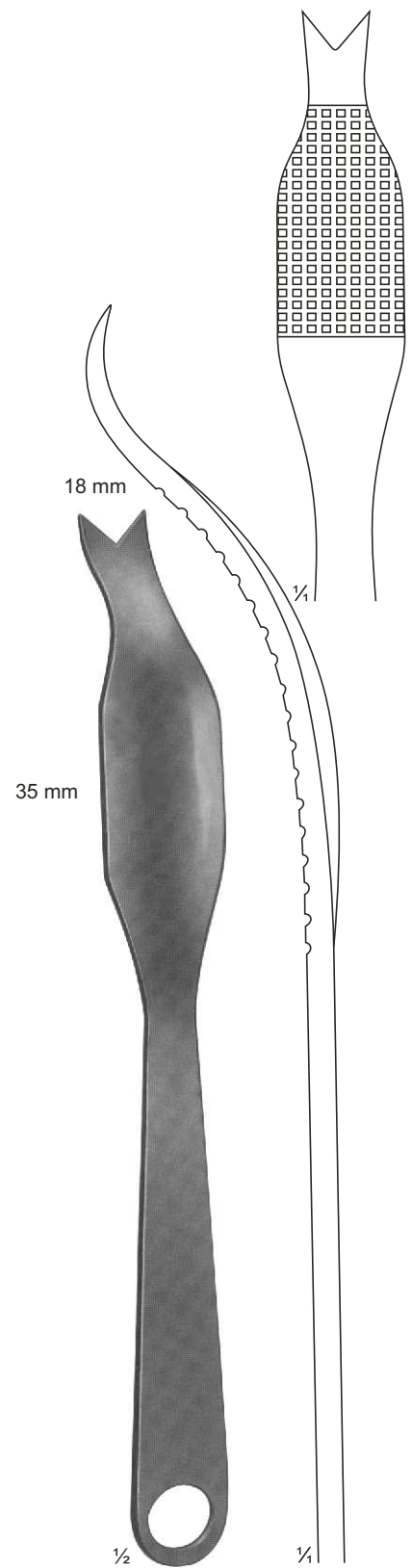

20-130
SCHUMACHER
290 mm

Special Bone Levers

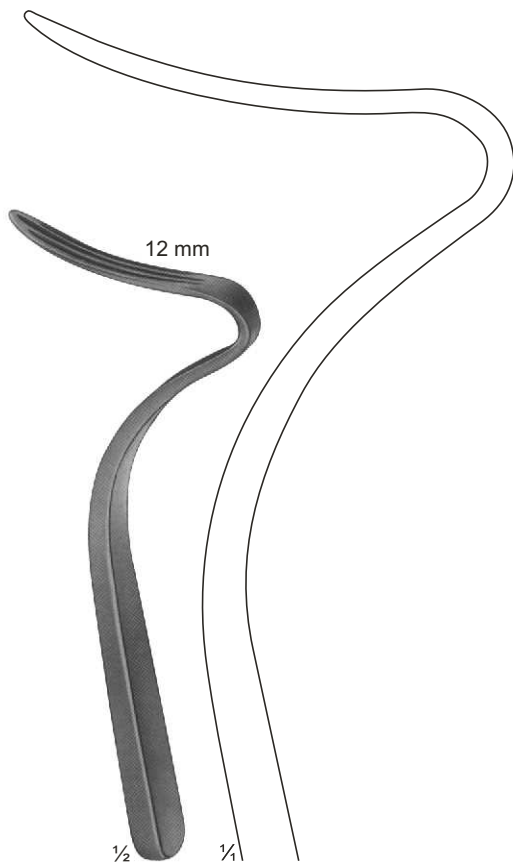

20-131
TAGER
 Bone lever for
 angle joint operations
 175 mm

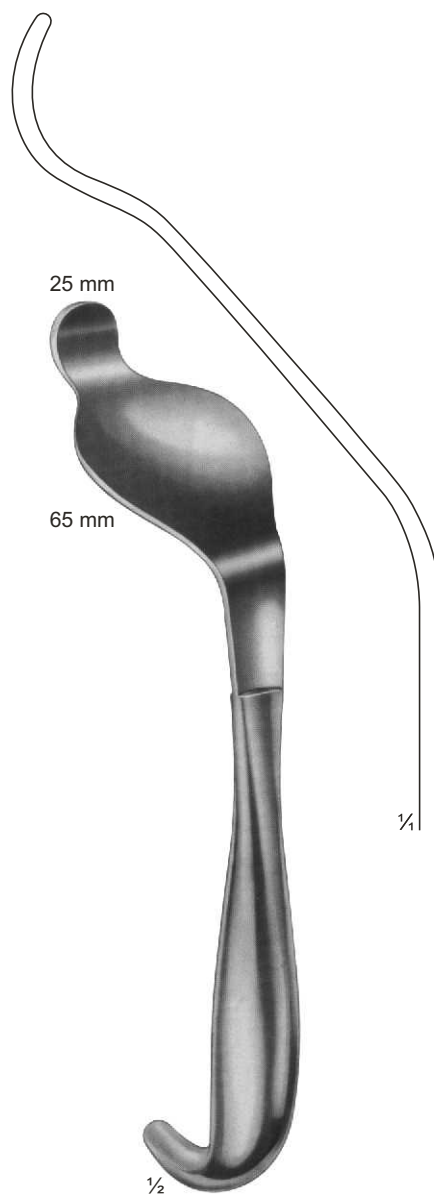

20-132
BENNETT
 235 mm

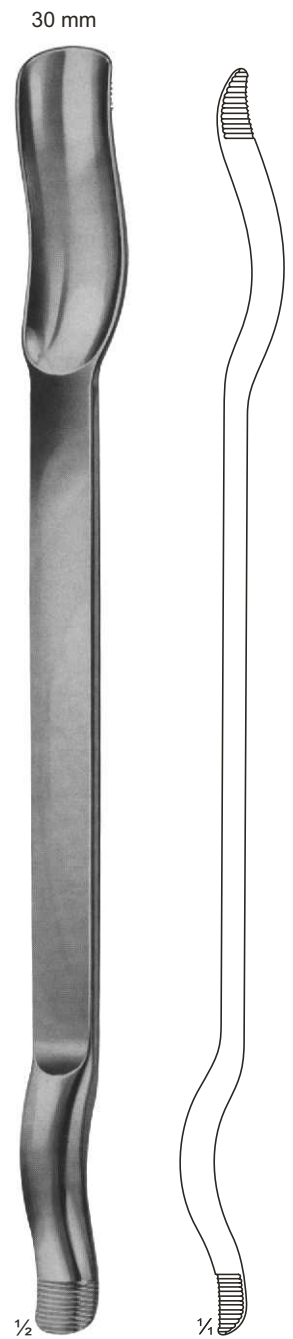

20-133
MURPHY-LANE
 Luxation lever
 340 mm

Raspatories

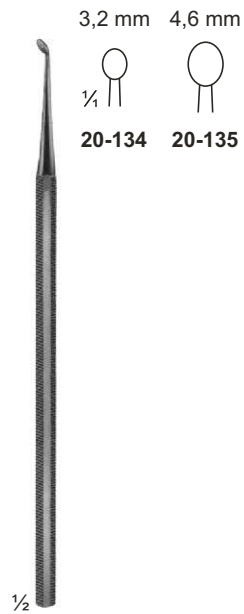

20-134 - 135
PARTSCH
150 mm

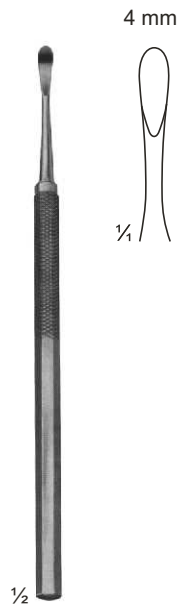

20-136
PARTSCH mod. LANGE
145 mm

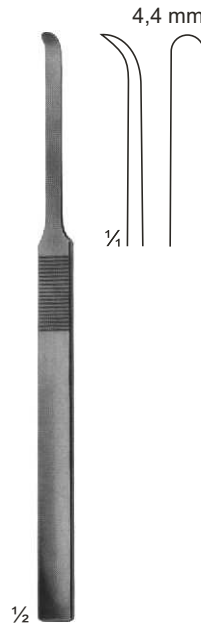

20-137
MC KENTY
155 mm

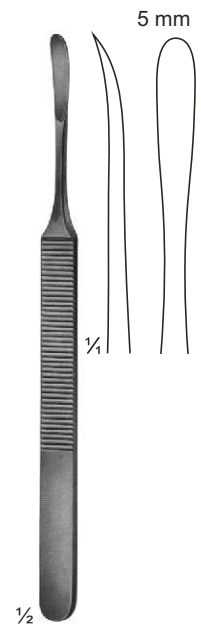

20-138
KONIG
155 mm

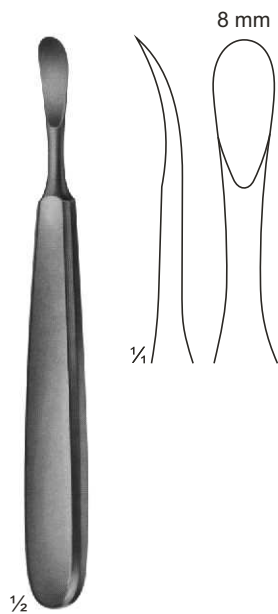

20-139
TRELAT
150 mm

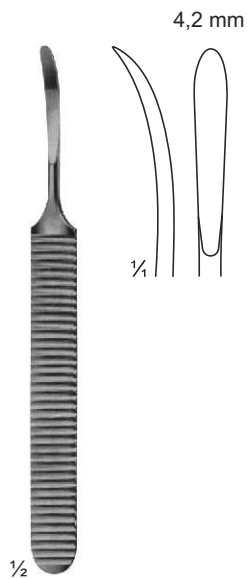

20-140
WILLIGER
140 mm

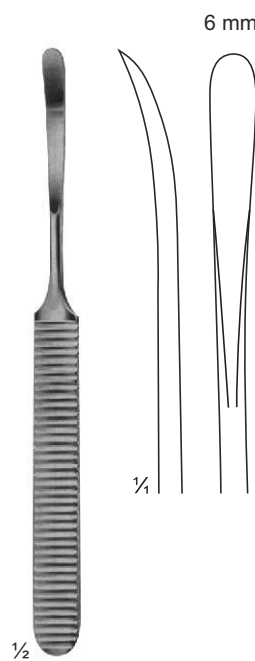

20-141
WILLIGER
160 mm

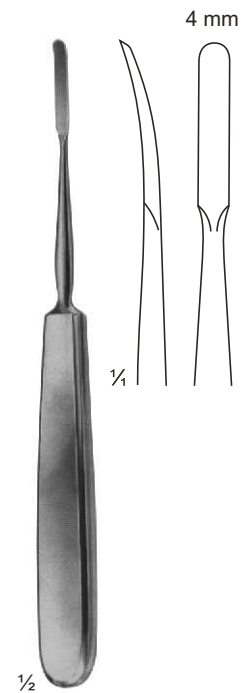

20-142
JOSEPH
170 mm

Raspatories

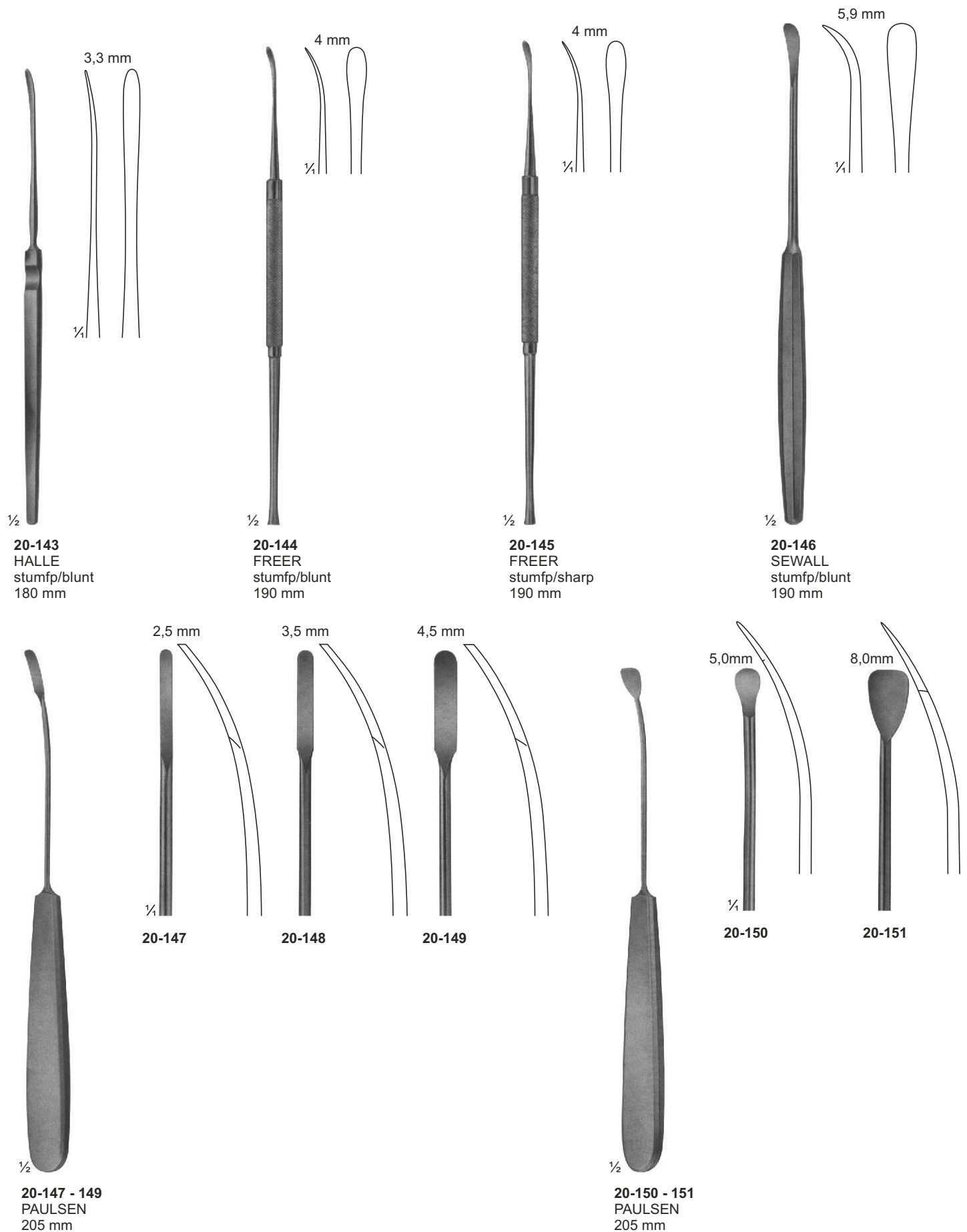

Raspatories

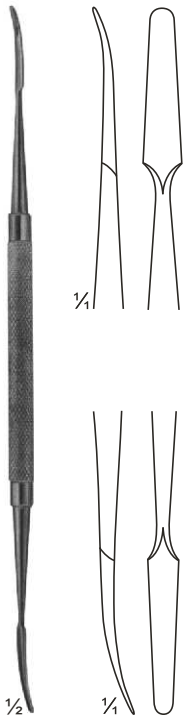

20-152
KILLIAN
sharp/blunt
185 mm

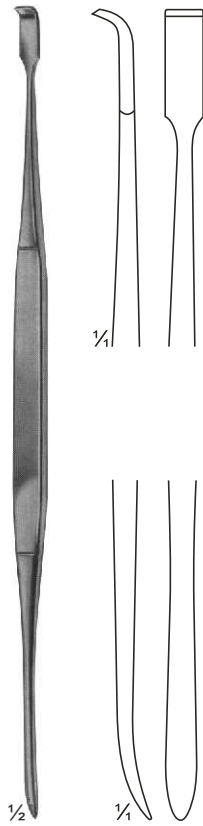

20-153
HOWARTH
sharp/blunt
215 mm

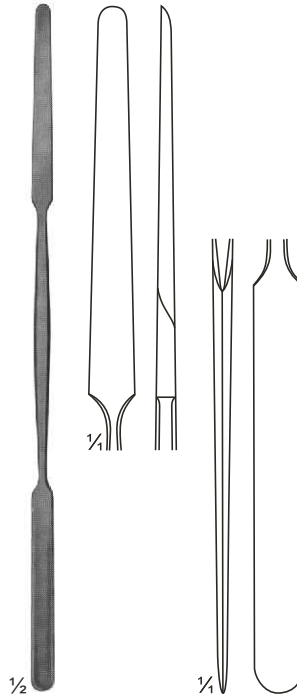

20-154
KILLIAN
sharp/blunt
185 mm

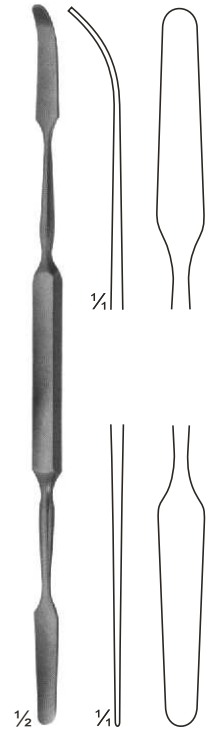

20-155
MAC DONALD
blunt/blunt
185 mm

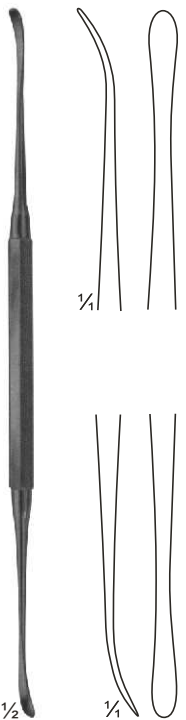

20-156
FREER
sharp/blunt
185 mm

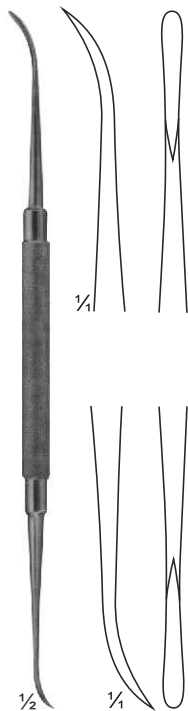

20-157
FREER-YASARGIL
sharp/sharp
185 mm

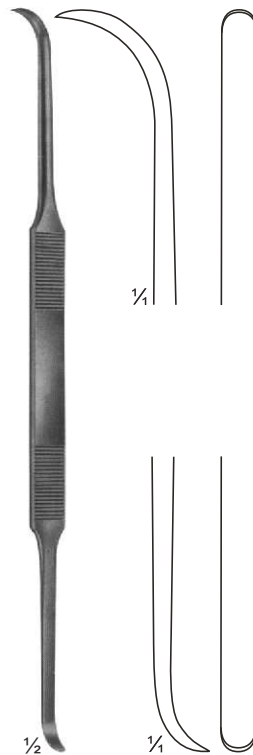

20-158
COTTLE
sharp/sharp
200 mm

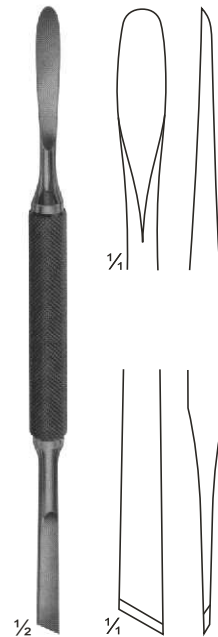

20-159
MEAD
sharp/sharp
165 mm

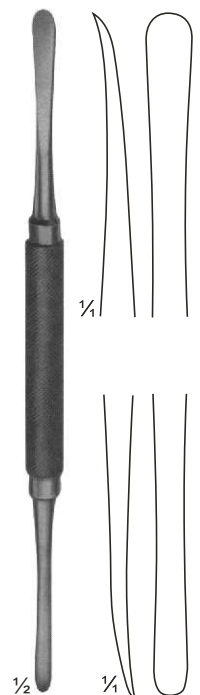

20-160
MOLT
sharp/sharp
180 mm

Raspatories

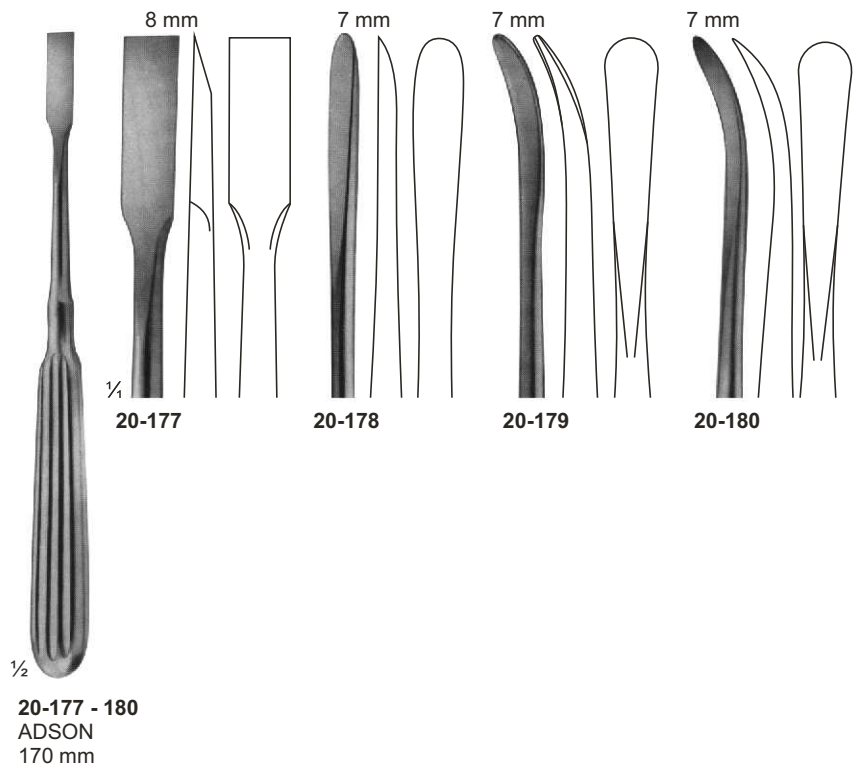
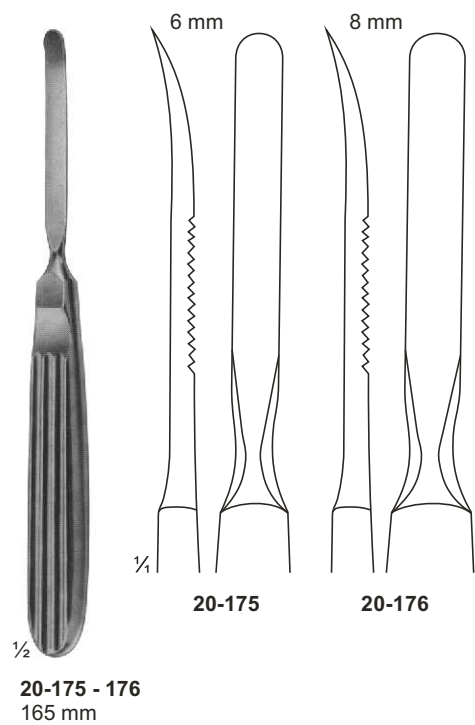
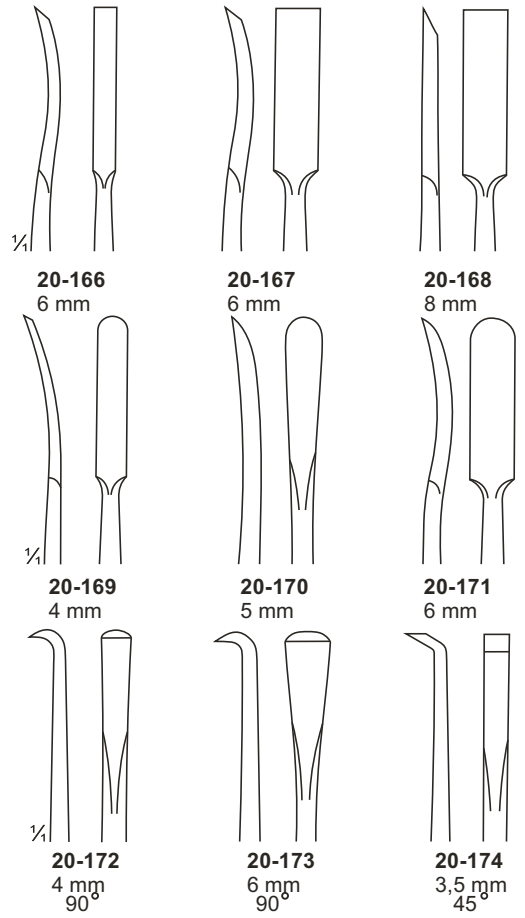
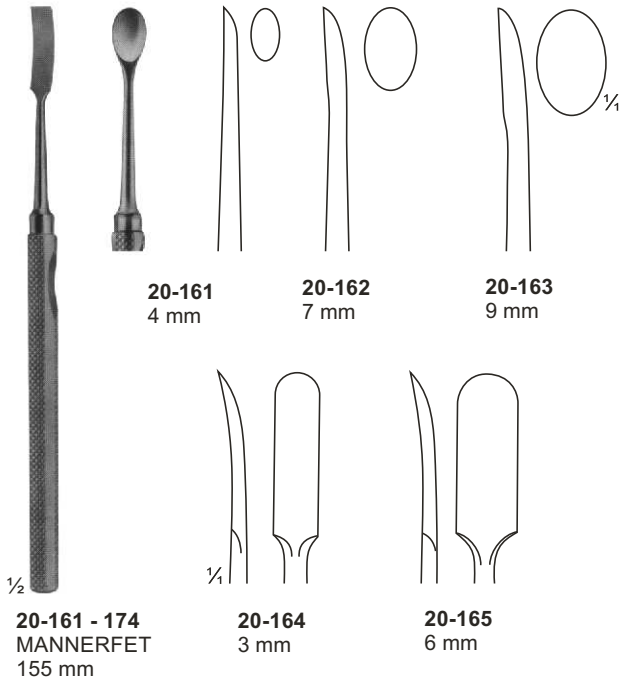

Raspatories

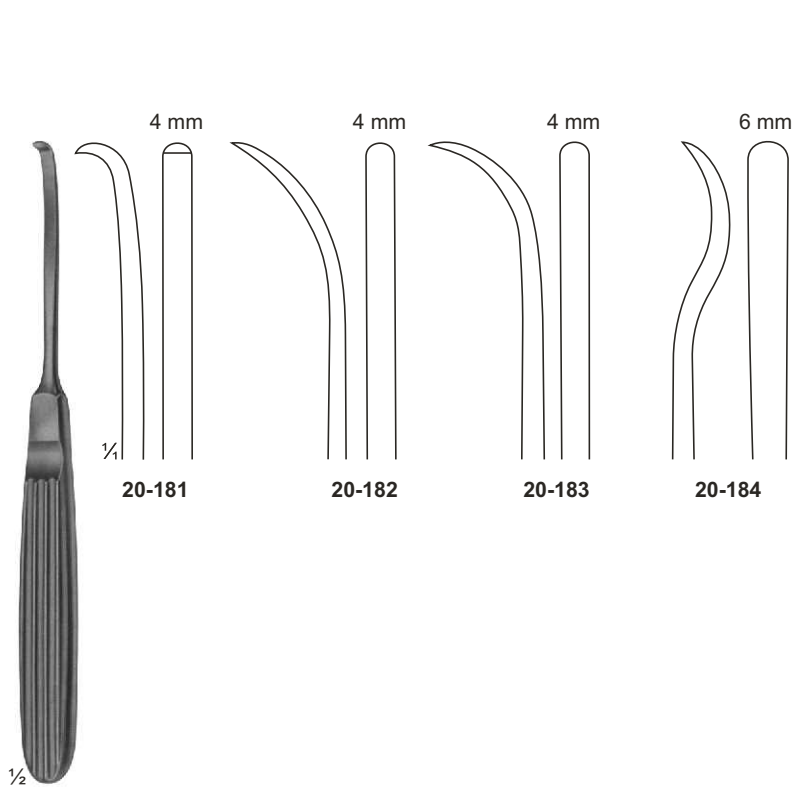

20-181 - 184
MUHLING
 170 mm

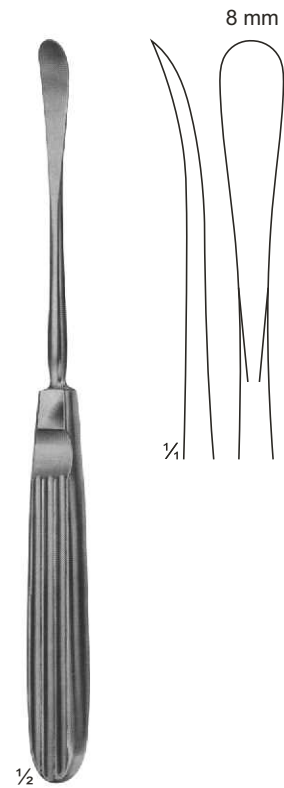

20-185
COTTLE
 175 mm

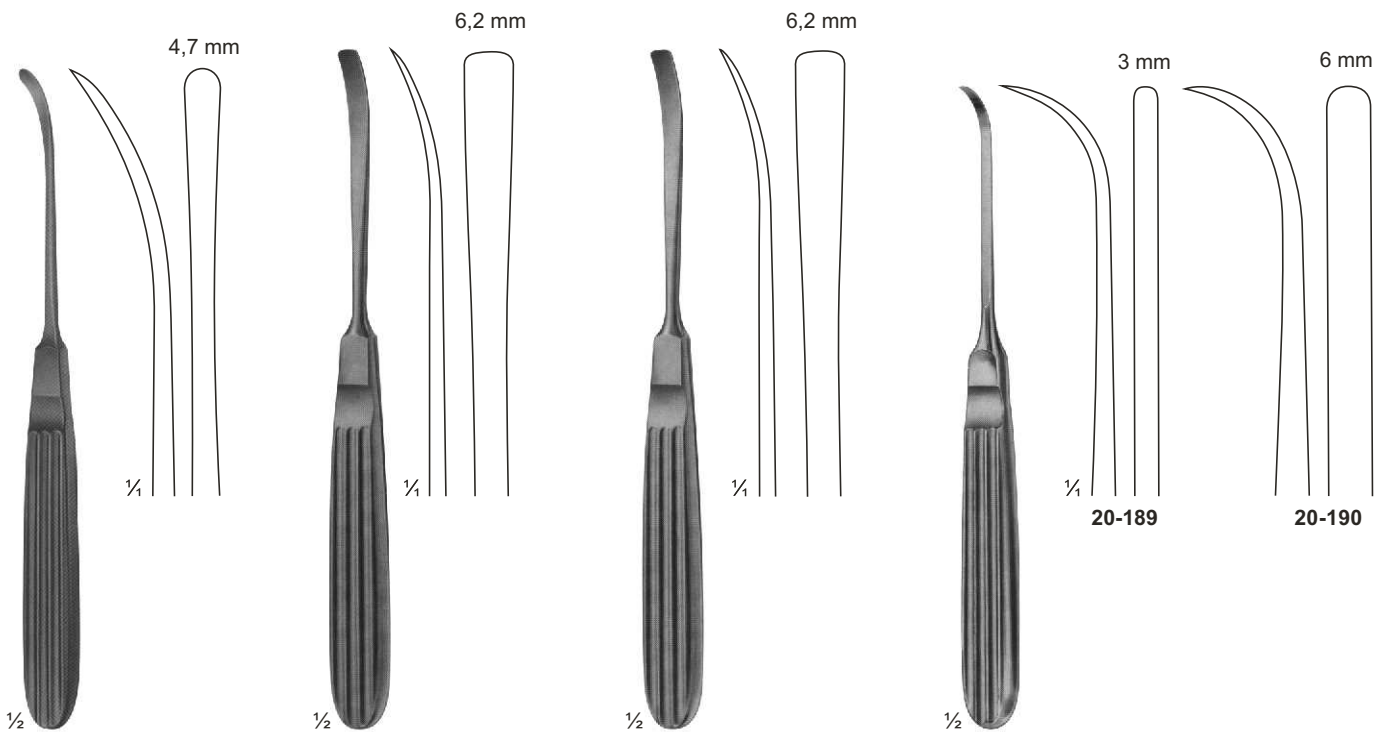

20-186
LANDOT
 175 mm

20-187
CASPER
 180 mm

20-188
CASPER
 180 mm

20-189 - 190
 170 mm

Raspatories

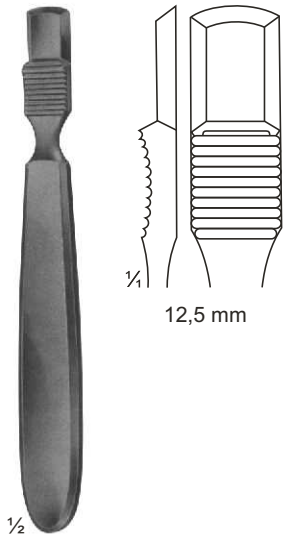

12,5 mm

1/2
20-191
FARABEUF
140 mm

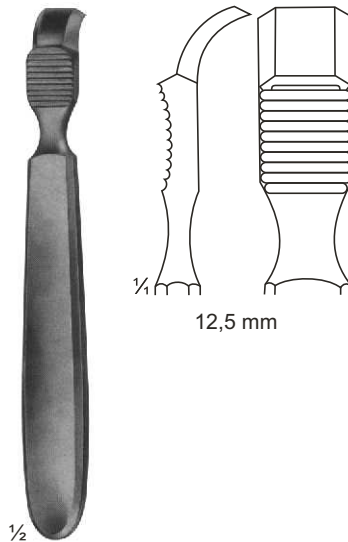

12,5 mm

1/2
20-192
FARABEUF
140 mm

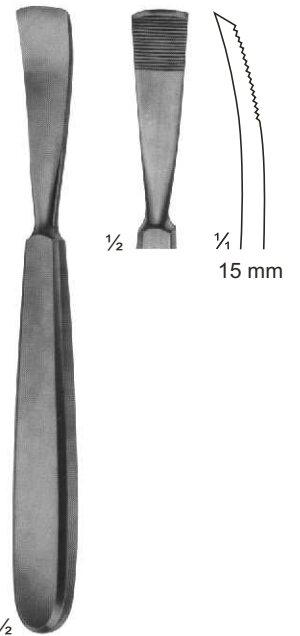

15 mm

1/2
20-193
JANSEN
165 mm

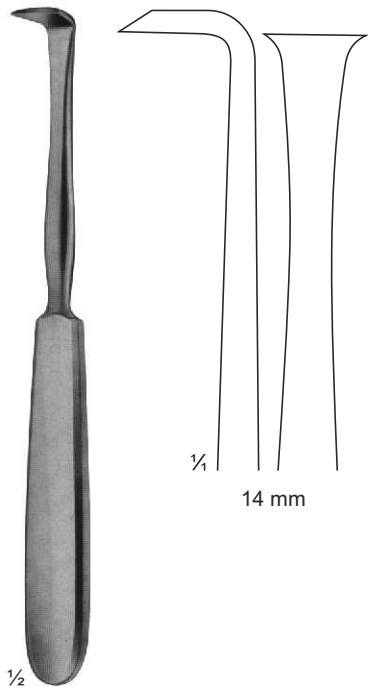

14 mm

1/2
20-194
LANGENBACK
180 mm

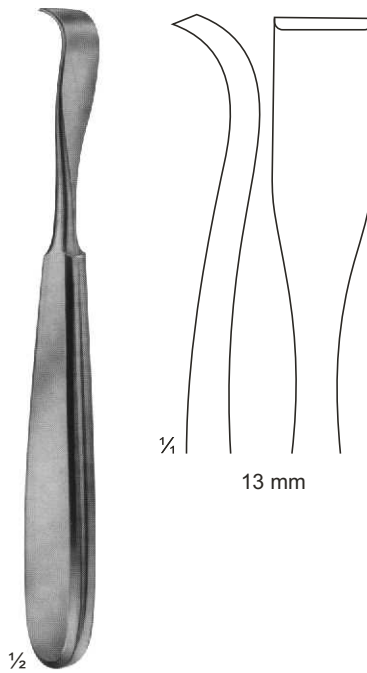

13 mm

1/2
20-195
SCHNEIDER
175 mm

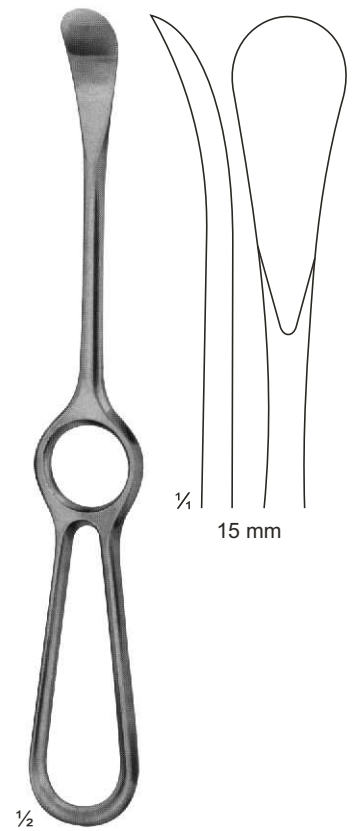

15 mm

1/2
20-196
SEDILLOT
215 mm

Raspatories

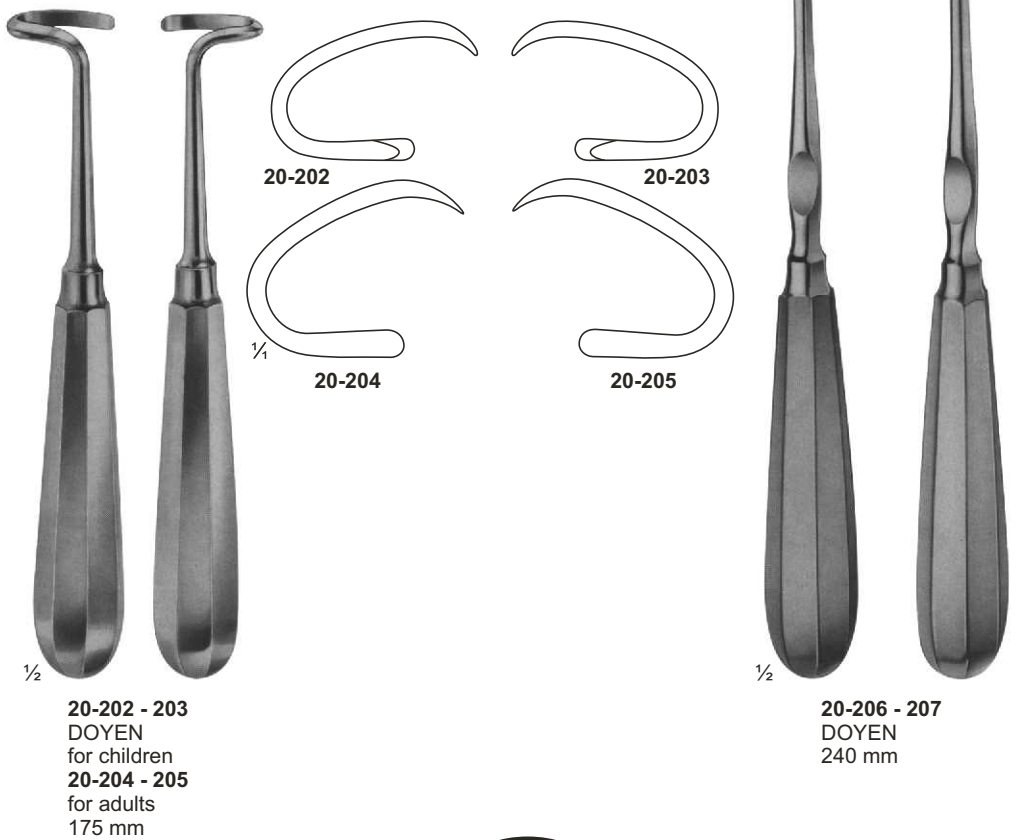
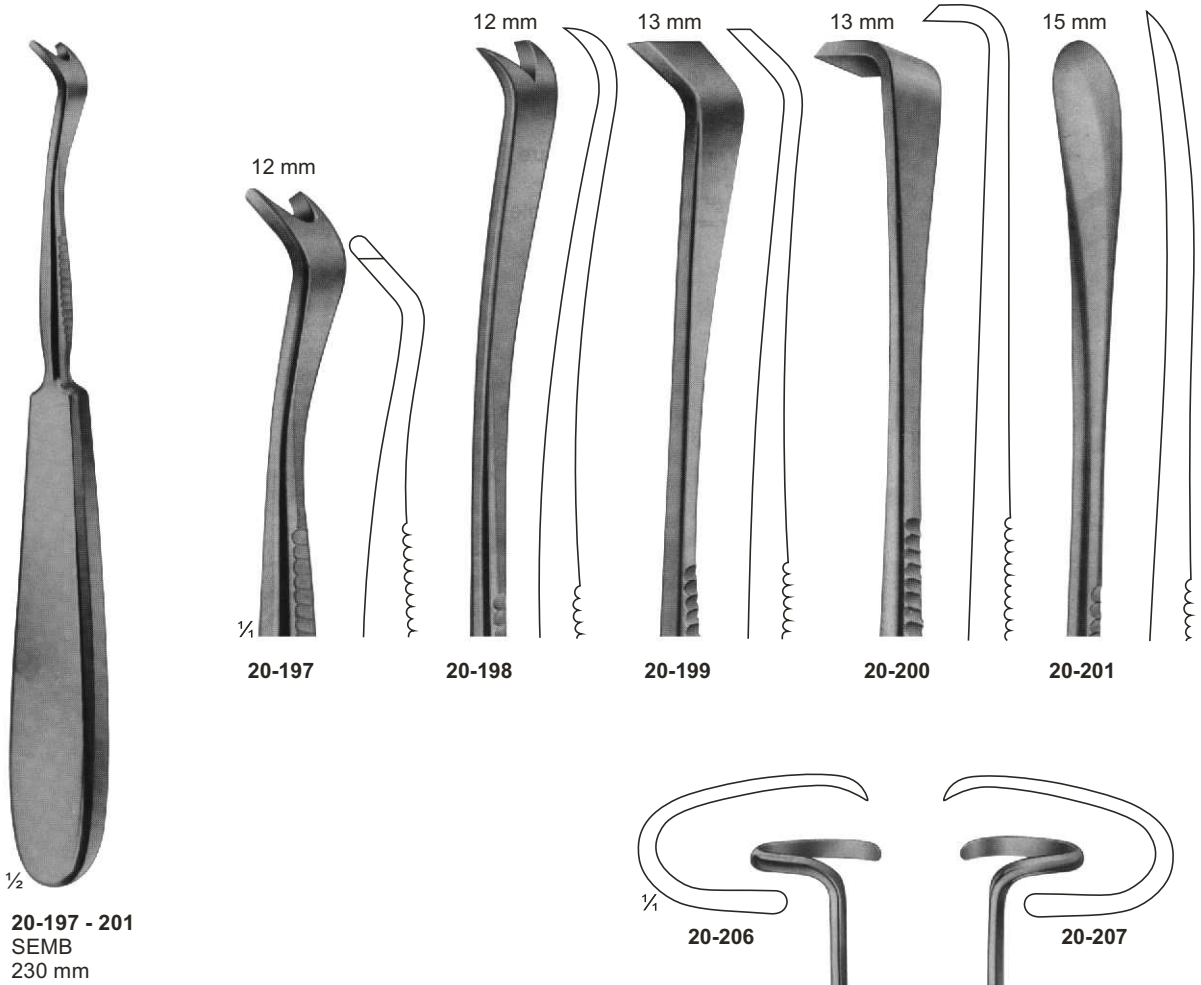

Raspatories with HARTPRESS-handle



Bone File and Rasps

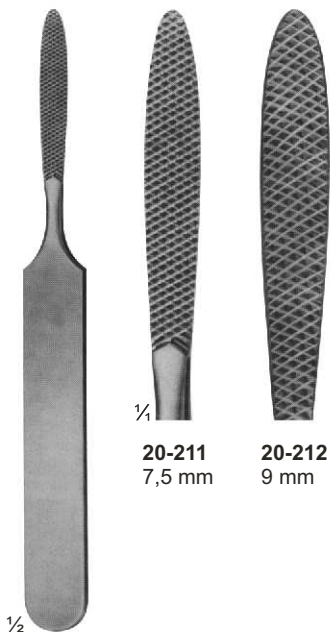

20-211
7,5 mm

20-212
9 mm

20-211
JOSEPH
fine, chequered

20-212
coarse, chequered
165 mm

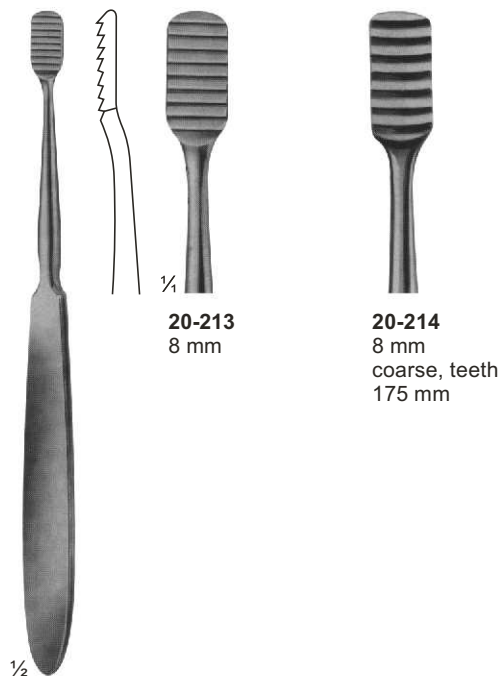

20-213
8 mm

20-214
8 mm
coarse, teeth
175 mm

20-213
LEWIS
fine, teeth



20-215
9 mm

20-215
MALTZ
down stroke
180 mm

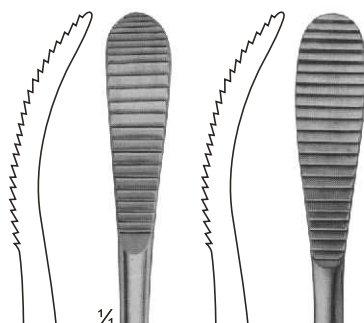

20-216
9 mm

20-217
9 mm



20-216
AUFRICHT
up stroke
20-217
down stroke
220 mm



20-218
6,5 mm

20-218
GALLAHER
190 mm

Bone File and Rasps

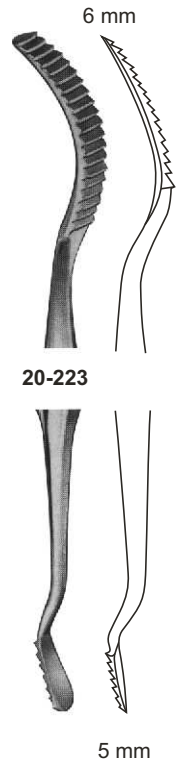
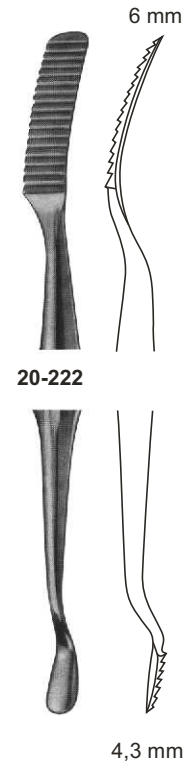
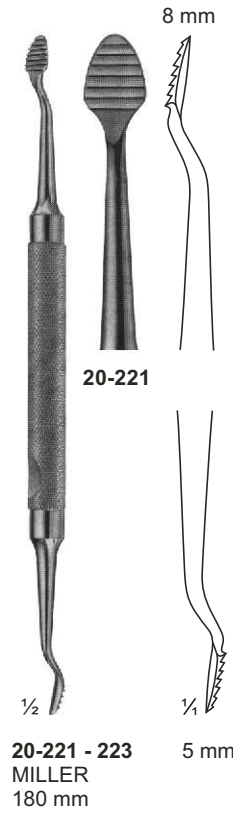
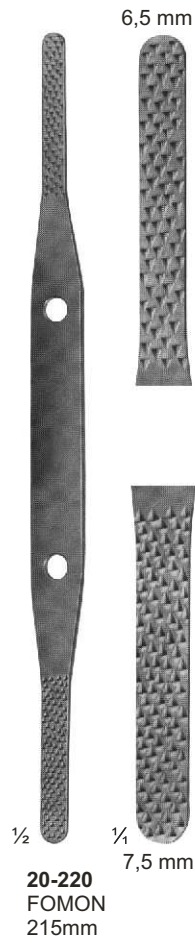
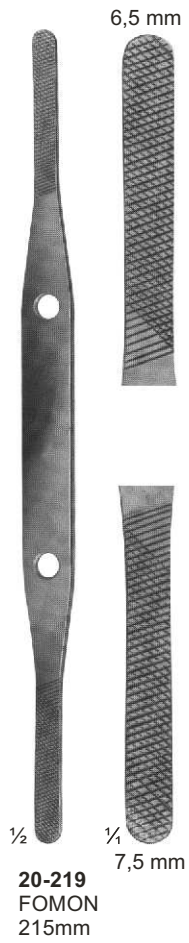

Bone File and Rasps

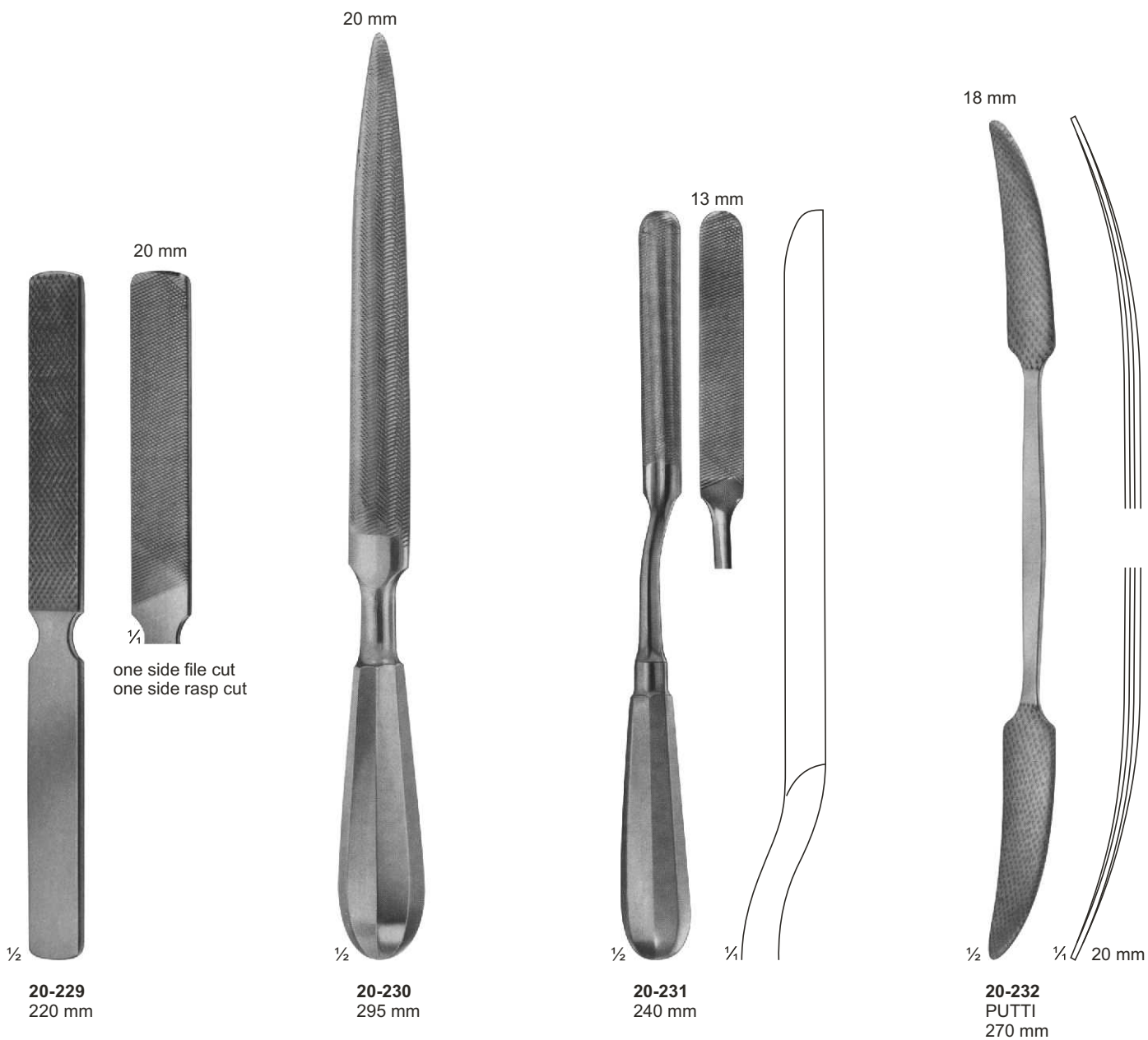

Bone Curettes

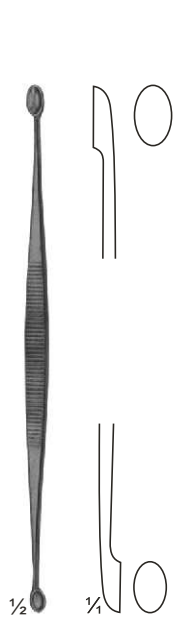

20-233
JACOBSON
140 mm

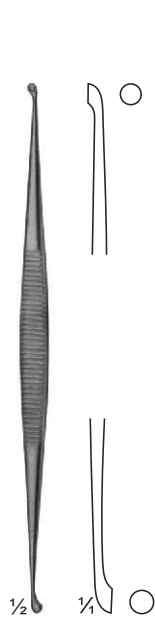

20-234
MARTINI
140 mm

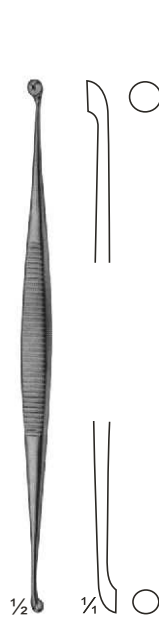

20-235
MARTINI
140 mm



20-236
WILLIGER
145 mm



20-237
JANSEN
160 mm



20-238
BARTH
180 mm

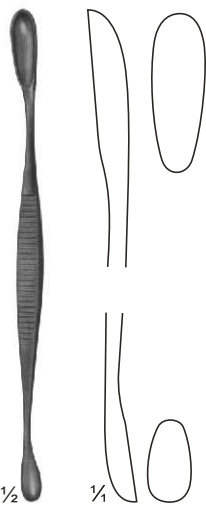

20-239
VOLKMANN
130 mm

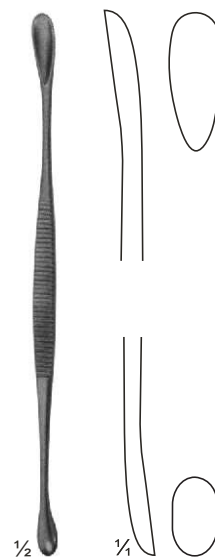

20-240
VOLKMANN
145 mm

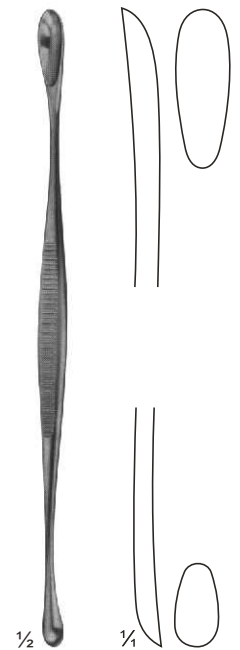

20-241
VOLKMANN
170 mm

Bone Curettes



20-242
JANSEN
160 mm

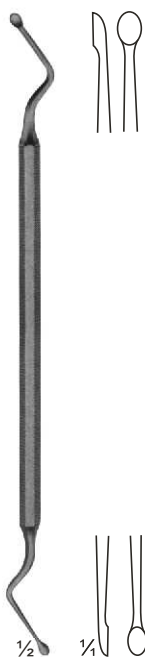

20-243
HEMINGWAY
170 mm

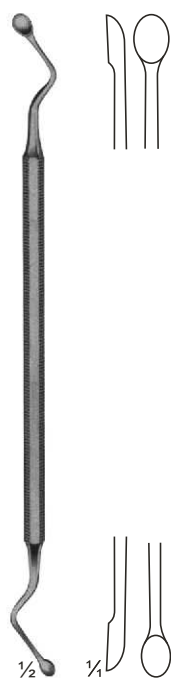

20-244
HEMINGWAY
175 mm

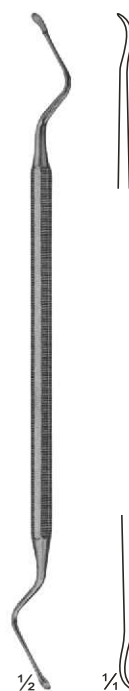

20-245
LUCAS
180 mm

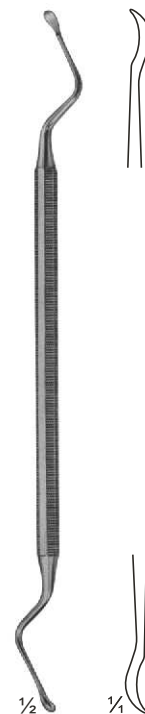

20-246
LUCAS
185 mm

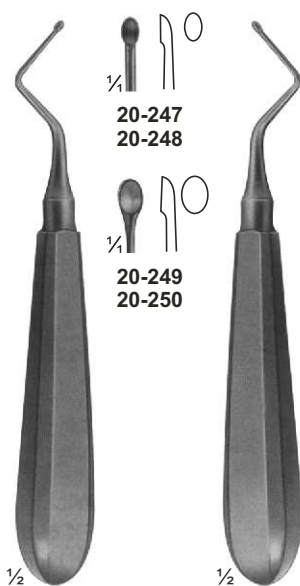

20-247 - 248
KERPEL
145 mm

20-249 - 250
KERPEL
145 mm

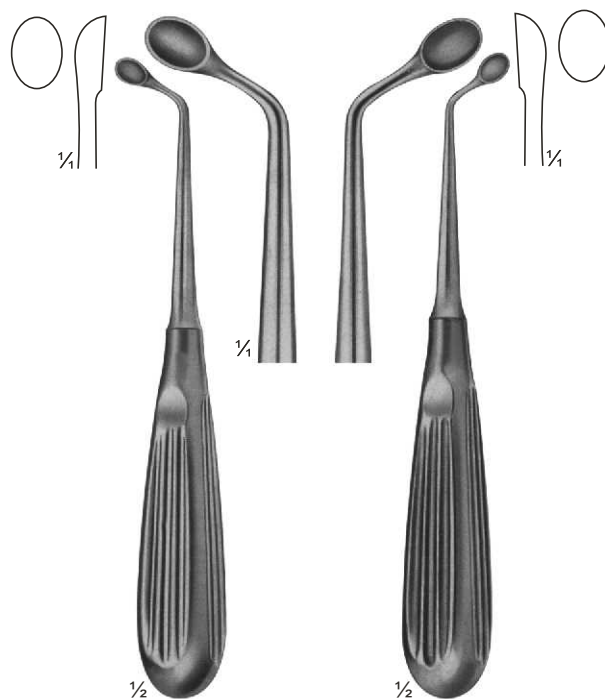

20-251
UFFENORDE
170 mm

20-252
UFFENORDE
170 mm

Bone Curettes



1/2



20-253
3 mm
Fig: 000



20-254
4 mm
00



20-255
5 mm
0



20-256
6 mm
Fig: 1



20-257
8 mm
2



20-258
10 mm
3

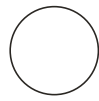

20-259
12 mm
4

20-253 - 259
BRUNS
165 mm



1/2



20-260
2,5 mm
Fig: 000



20-261
3,4 mm
00



20-262
4,2 mm
0



20-263
5,2 mm
Fig: 1



20-264
6,3 mm
2



20-265
7,4 mm
3



20-266
8 mm
4

20-260 - 266
SCHEDE
170 mm



1/2



20-267
2,8 mm
Fig: 0000



20-268
3,6 mm
000



20-269
4,4 mm
00



20-270
5,2 mm
0



20-271
6,8 mm
1



20-272
8,5 mm
Fig: 2

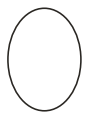

20-273
10 mm
3



20-274
11,5 mm
4

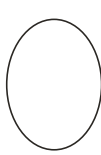

20-275
13 mm
5

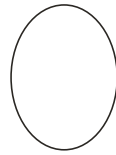

20-276
14,5 mm
6

20-267 - 276
VOLKMANN
170 mm



1/2



20-277
3,4 mm
Fig: 00





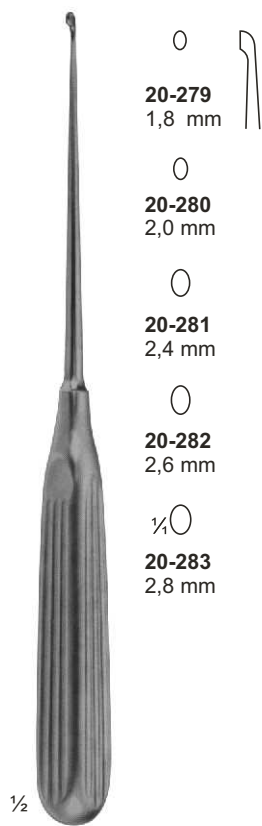

20-278
5,2 mm
1

20-277 - 278
WILLIGER
170 mm

Bone Currettes



-  **20-279**
1,8 mm
-  **20-280**
2,0 mm
-  **20-281**
2,4 mm
-  **20-282**
2,6 mm
-  **20-283**
2,8 mm



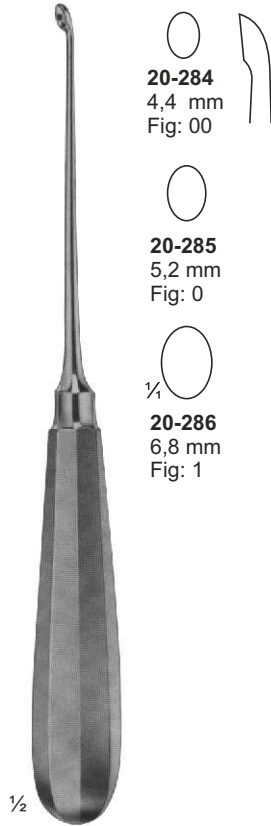

20-279 - 283
LEMPERT
215 mm

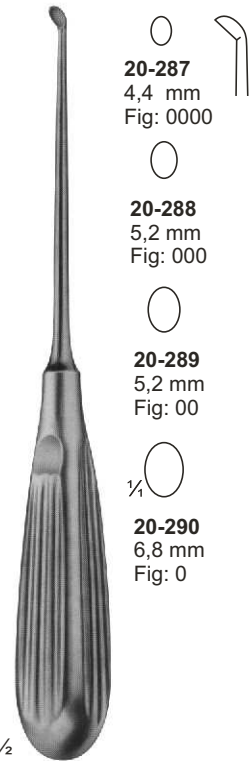

-  **20-284**
4,4 mm
Fig: 00
-  **20-285**
5,2 mm
Fig: 0
-  **20-286**
6,8 mm
Fig: 1





20-284 - 286
HALLE
215 mm



-  **20-287**
4,4 mm
Fig: 0000
-  **20-288**
5,2 mm
Fig: 000
-  **20-289**
5,2 mm
Fig: 00
-  **20-290**
6,8 mm
Fig: 0

20-287 - 290
DAUBENSPECK
200 mm



-  **20-291**
3,6 mm
Fig: 000
-  **20-292**
4,4 mm
Fig: 00
-  **20-293**
5,2 mm
Fig: 0
-  **20-294**
6,8 mm
Fig: 1



20-291 - 294
250 mm



-  **20-295**
3,6 mm
Fig: 000
-  **20-296**
4,4 mm
Fig: 00
-  **20-297**
5,2 mm
Fig: 0
-  **20-298**
6,8 mm
Fig: 1

20-295 - 298
250 mm



-  **20-299**
3 mm
-  **20-300**
4 mm
-  **20-301**
5 mm

20-299 - 301
BUSHE
250 mm

Bone Curettes



6 mm

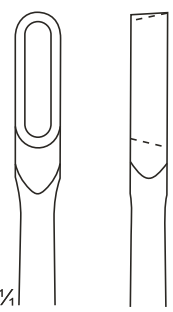

1/1

20-302
TESSIER
220 mm

1/2



20-303
3,6 mm
Fig: 000



20-304
4,4 mm
Fig: 00



20-305
5,2 mm
Fig: 0



20-303 - 305
SIMON
235 mm

1/2



20-306
6,8 mm
Fig: 1



20-307
8,5 mm
Fig: 2



20-308
10 mm
Fig: 3

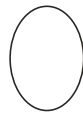

20-309
11,5 mm
Fig: 4

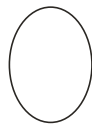

20-310
13 mm
Fig: 5

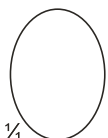

20-311
14,5 mm
Fig: 6

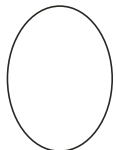

20-306 - 311
SIMON
240 mm

1/2



20-312
3,6 mm
Fig: 000

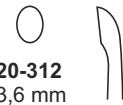

20-313
4,4 mm
Fig: 00



20-314
5,2 mm
Fig: 0



20-312 - 314
CASPAR
220 mm

1/2



20-315
3,6 mm
Fig: 000

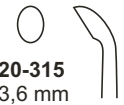

20-316
4,4 mm
Fig: 00



20-317
5,2 mm
Fig: 0



20-315 - 317
CASPAR
220 mm

1/2



20-318
4 mm



20-319
5 mm

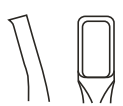

20-320
6 mm

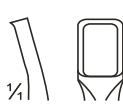

20-318 - 320
CASPAR
toothed
220 mm

1/2

Bone Currettes

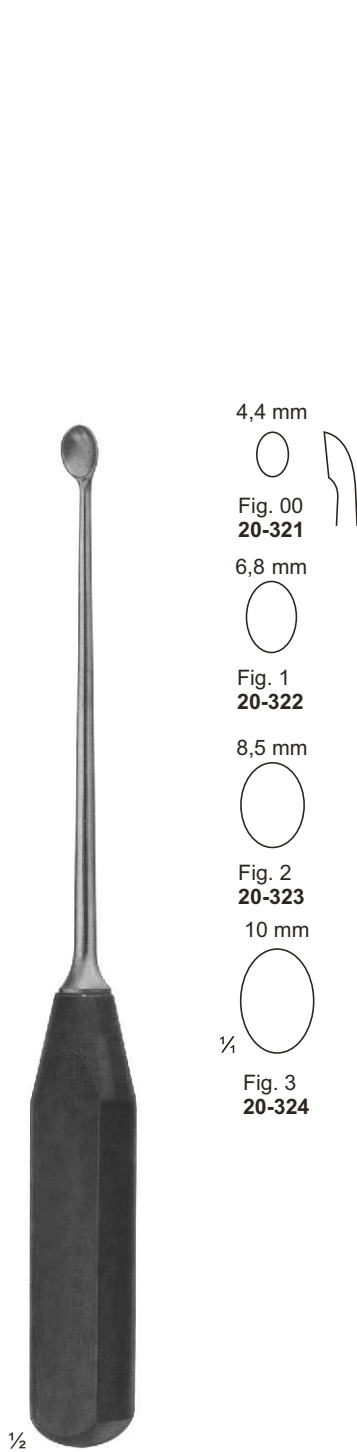

20-321 - 324
270 mm

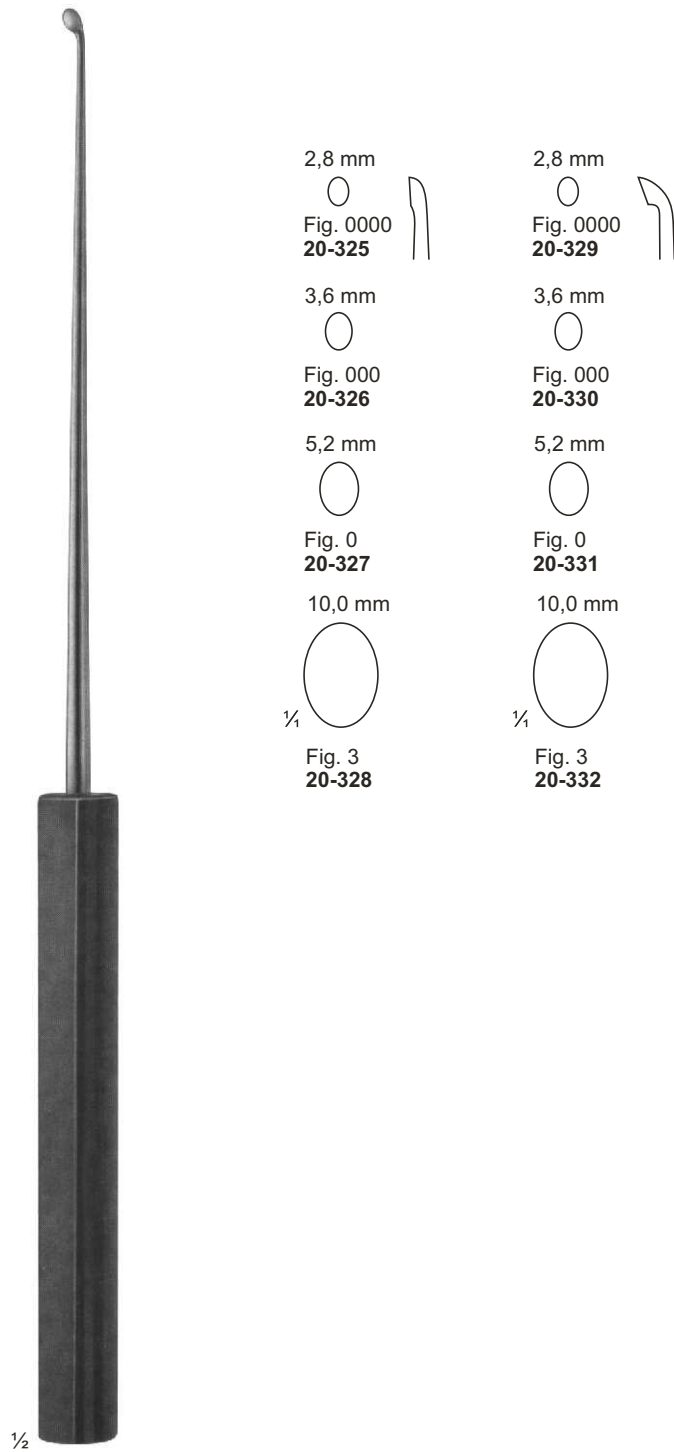

20-325 - 332
SYPERT
380 mm

Mallets



Ø 20 mm

1/2

21-101
MEAD
185 g
with interchangeable
plastic disks
190 mm
21-102
pair of spare disks



1/2

21-103
140 g
with interchangeable
plastic disks
185 mm
21-104
pair of spare disks



Ø 25 mm

1/2

21-105
COTTLE
140 g
1 Seite convex
1 Side convex
185 mm



Ø 22 mm

1/2

21-106
165 g
lead filled head
190 mm

Mallets



21-107
HAJEK
140 g
215 mm



21-108
215 g
with interchangeable
plastic disks
245 mm
21-109
pair of spare disks

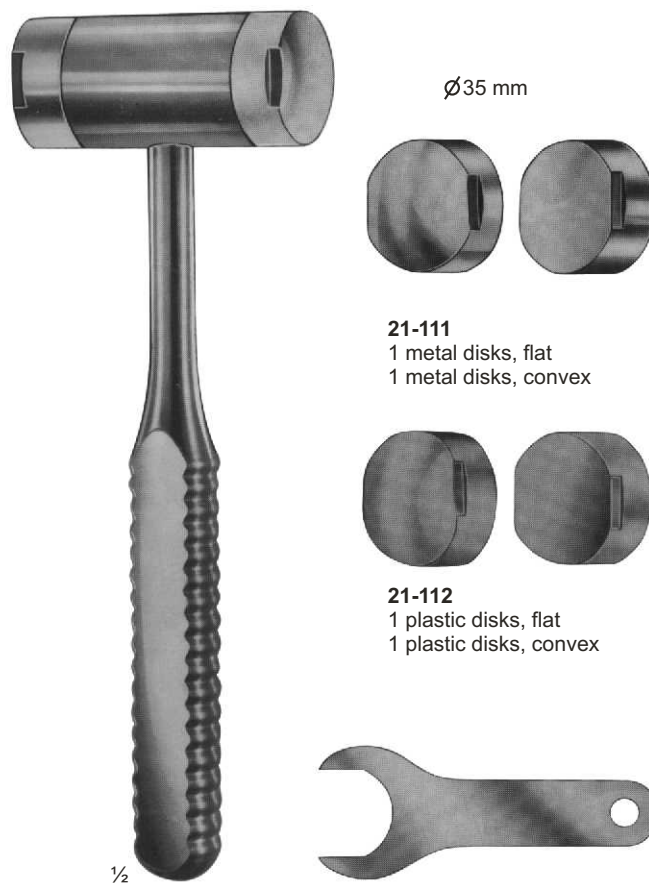

21-110 - 113
WAGNER
complete with:
1 pair of metal disks and
1 pair of plastic disks and
1 wrench 566
235 mm

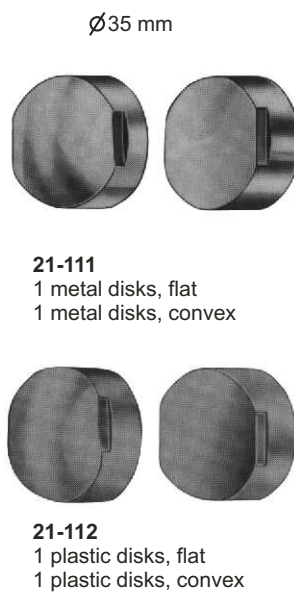

21-111
1 metal disks, flat
1 metal disks, convex

21-112
1 plastic disks, flat
1 plastic disks, convex

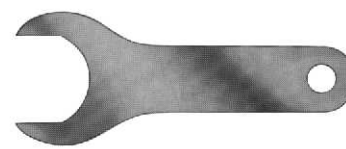

21-113
Wrench

Mallet without disks 130 g

Mallets



21-114
BERGMANN
245 mm



21-115
BERGMANN
235 mm



21-116
OMBREDANNE
240 mm

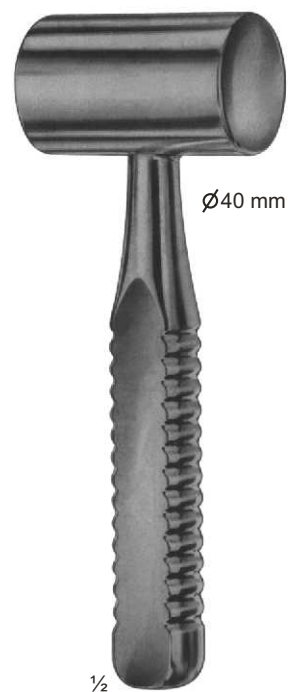

21-117
HEATH
copper filled head
700 g
185 mm

Tampers - Osteotomes, Chisels and Gouges

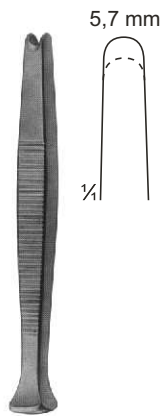

21-118
Haase
100 mm



21-119 - 120
PASSOW
120 mm



21-121 - 123
CASPER
200 mm

- 21-121
ø3 mm
- 21-122
ø5 mm
- 1/4 21-123
ø8 mm



21-124 - 126
200 mm

- 21-124
ø12 mm
- 21-125
ø14 mm
- 1/4 21-126
ø16 mm

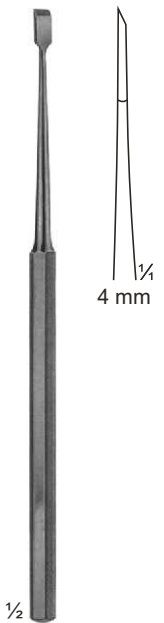

21-127
FREER
Chisel
160 mm

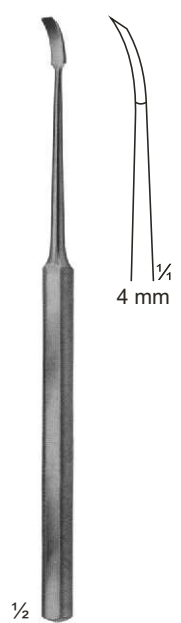

21-128
FREER
Chisel, curved
160 mm

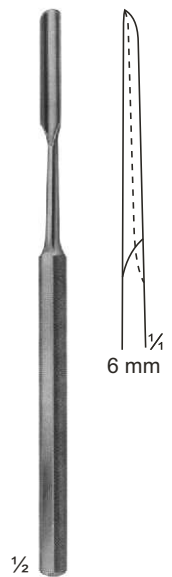

21-129
FREER
Gouge
150 mm

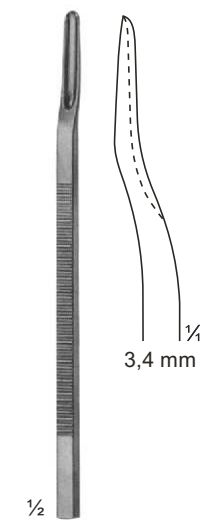

21-130
Scaphoid gouge,
downwards curved
135 mm

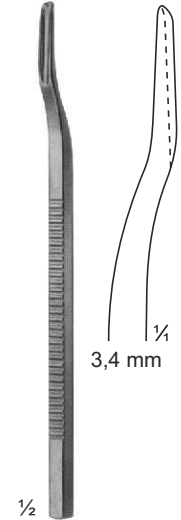

21-131
Scaphoid gouge,
upwards curved
135 mm

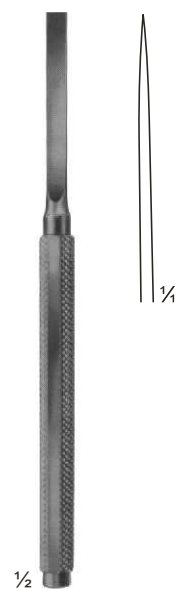

21-131A - 133
Mannerfelt
21-131A 4 mm
21-132 6 mm
21-133 8 mm
155 mm

Osteotomes Chisels and Gouges

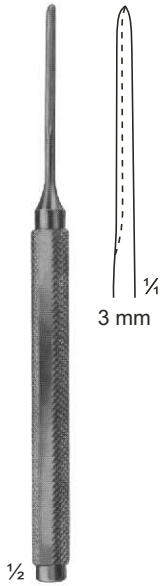

21-134
Mannerfelt
155 mm

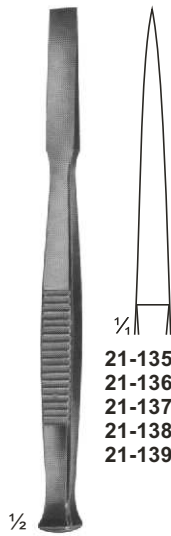

21-135 - 139
Osteotome
140 mm

- 21-135** 4 mm
- 21-136** 6 mm
- 21-137** 8 mm
- 21-138** 10 mm
- 21-139** 12 mm

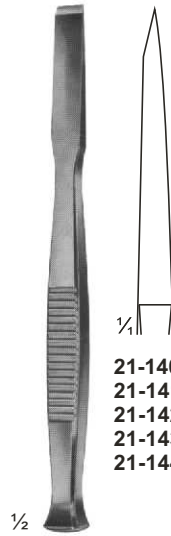

21-140 - 144
Chisels
140 mm

- 21-140** 4 mm
- 21-141** 6 mm
- 21-142** 8 mm
- 21-143** 10 mm
- 21-144** 12 mm

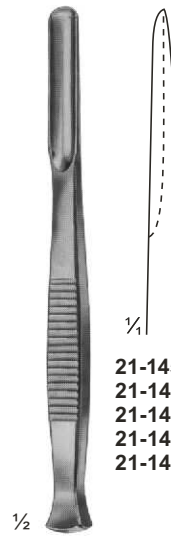

21-145 - 149
Gouges
140 mm

- 21-145** 4 mm
- 21-146** 6 mm
- 21-147** 8 mm
- 21-148** 10 mm
- 21-149** 12 mm

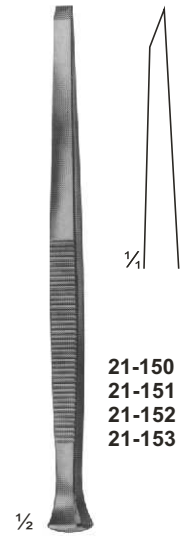

PARTSCH
21-150 - 153
Chisels
140 mm

- 21-150** 3 mm
- 21-151** 4 mm
- 21-152** 5 mm
- 21-153** 6 mm

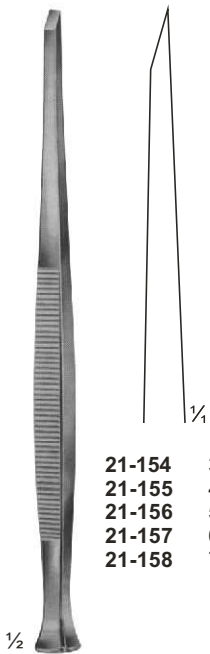

PARTSCH
21-154 - 158
Chisels
170 mm

- 21-154** 3 mm
- 21-155** 4 mm
- 21-156** 5 mm
- 21-157** 6 mm
- 21-158** 7 mm

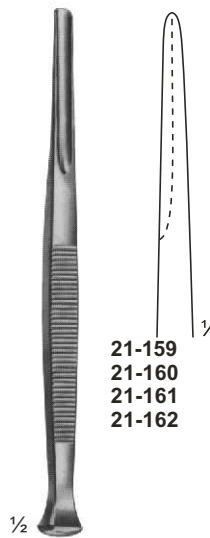

PARTSCH
21-159 - 162
Gouges
140 mm

- 21-159** 3 mm
- 21-160** 4 mm
- 21-161** 5 mm
- 21-162** 6 mm

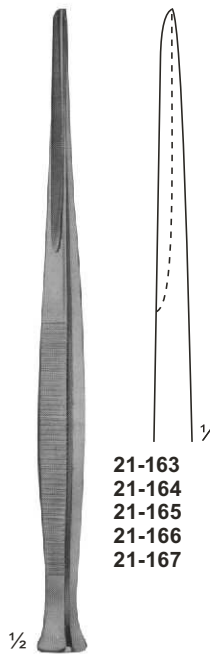

PARTSCH
21-163 - 167
Gouges
170 mm

- 21-163** 3 mm
- 21-164** 4 mm
- 21-165** 5 mm
- 21-166** 6 mm
- 21-167** 7 mm

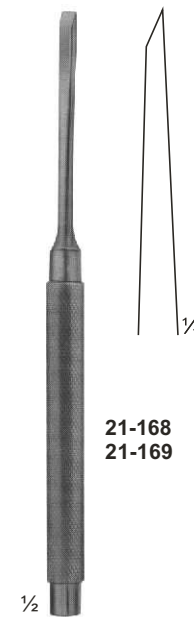

LUCAS
21-168 - 169
Chisels
160 mm

- 21-168** 4 mm
- 21-169** 6 mm

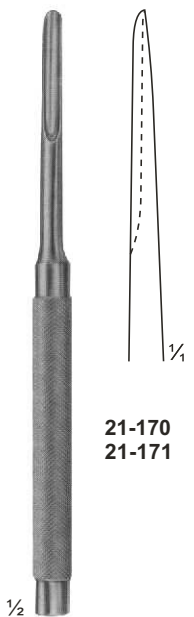

LUCAS
21-170 - 171
Gouges
160 mm

- 21-170** 3 mm
- 21-171** 5 mm

Osteotomes Chisels and Gouges

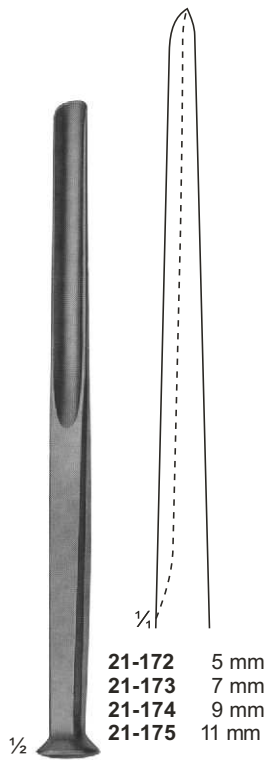

21-172 5 mm
21-173 7 mm
21-174 9 mm
21-175 11 mm

ALEXANDER
21-172 - 175
Gouges
170 mm

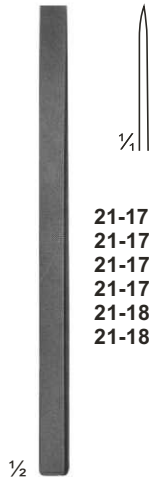

21-176 4 mm
21-177 6 mm
21-178 8 mm
21-179 10 mm
21-180 12 mm
21-181 15 mm

LAMBOTTE
21-176 - 181
Osteotome
125 mm

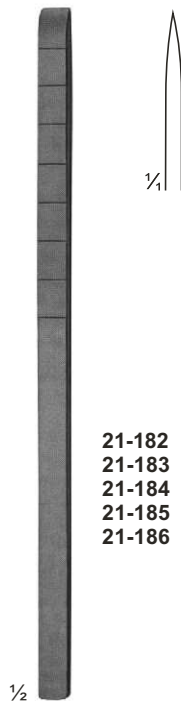

21-182 4 mm
21-183 6 mm
21-184 8 mm
21-185 10 mm
21-186 12 mm

COTTLE
21-182 - 186
Osteotome with depth
markings
180 mm

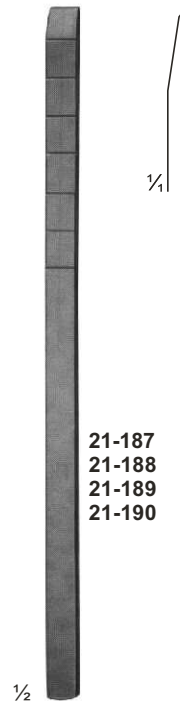

21-187 4 mm
21-188 7 mm
21-189 9 mm
21-190 12 mm

COTTLE
21-187 - 190
Chisel-Osteotomes
with depth markings
180 mm

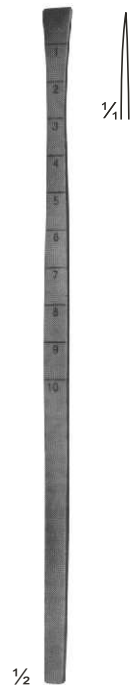

COTTLE
21-191
Fishtail Chisel,
with protected ends
180 mm

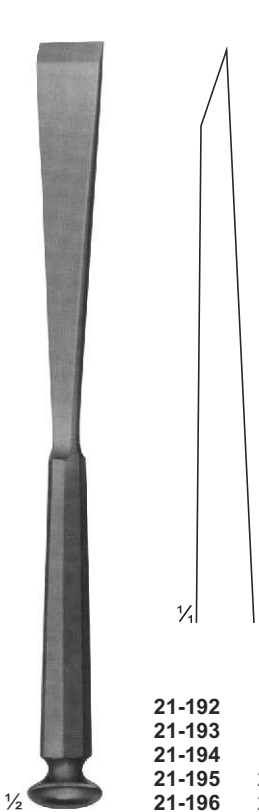

21-192 10 mm
21-193 12 mm
21-194 15 mm
21-195 20 mm
21-196 25 mm

STILLE
21-192 - 196
Chisels
205 mm

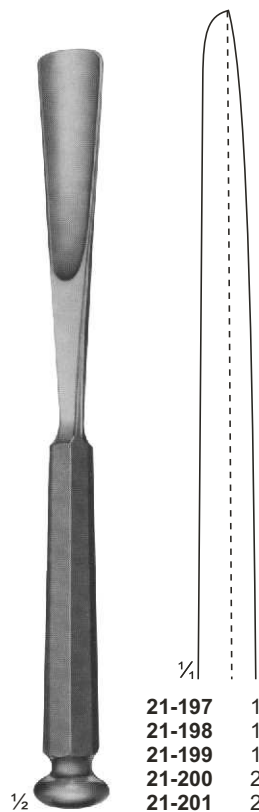

21-197 10 mm
21-198 12 mm
21-199 15 mm
21-200 20 mm
21-201 25 mm

STILLE
21-197 - 201
Gouges
205 mm

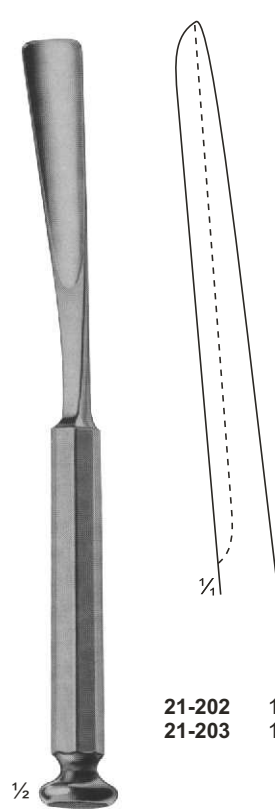

21-202 10 mm
21-203 15 mm

WALTER
21-202 - 203
Osteotome
gouges for taking
grafts from the rib
205 mm

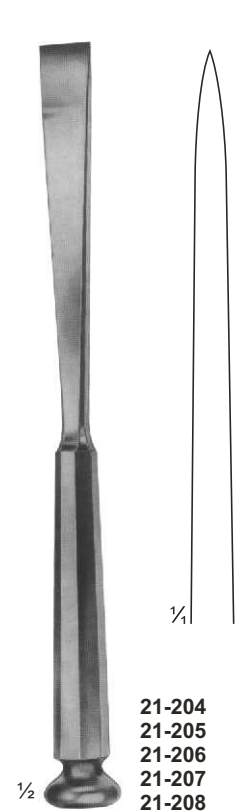

21-204 8 mm
21-205 12 mm
21-206 15 mm
21-207 20 mm
21-208 25 mm

STILLE
21-204 - 208
Osteotomes
205 mm

Osteotomes

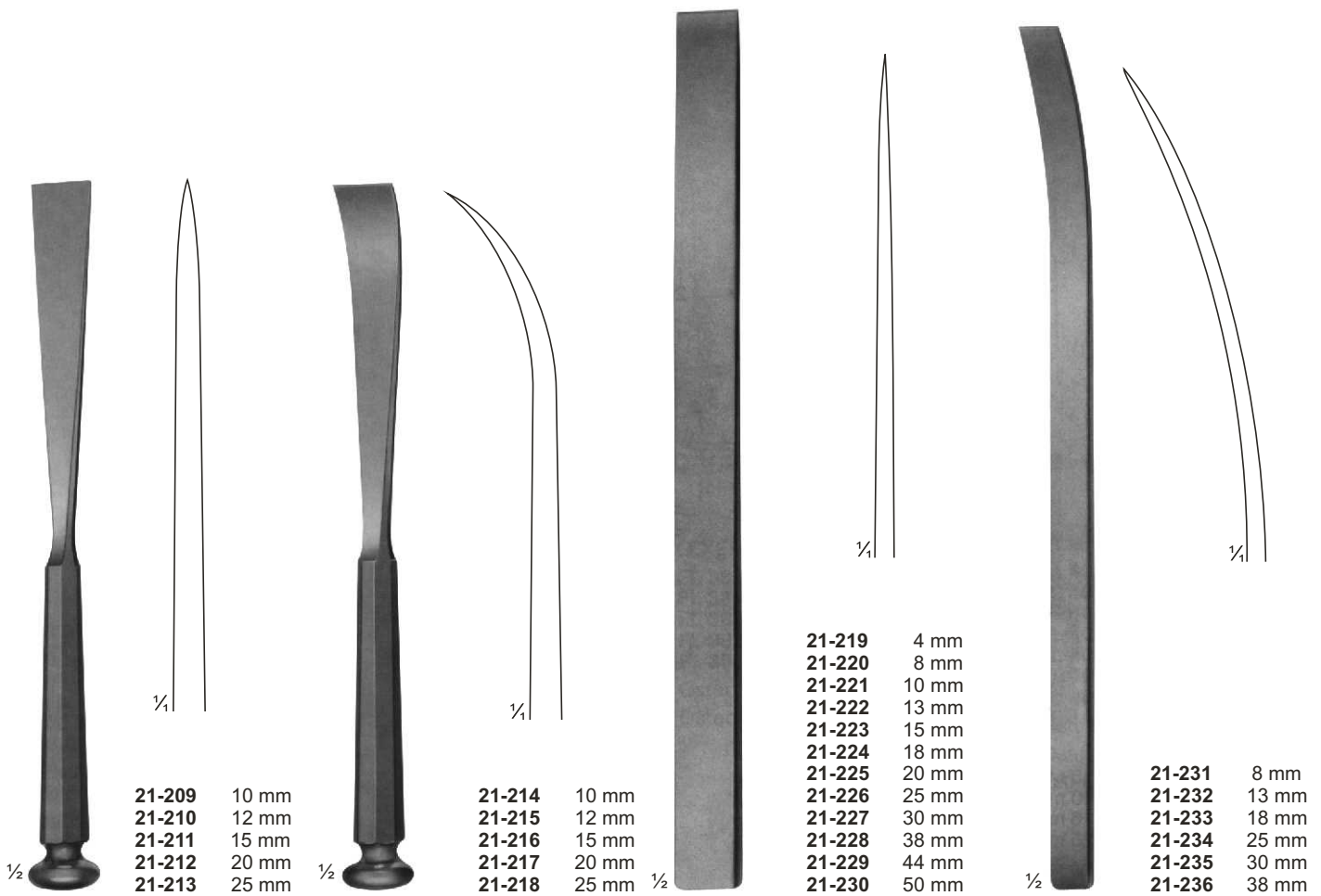

STILLE
21-209 - 213
Osteotomes
205 mm

STILLE
21-214 - 218
Osteotomes, curved
205 mm

LAMBOTTE
21-219 - 230
Osteotomes
245 mm

LAMBOTTE
21-231 - 236
Osteotomes, curved
245 mm

Osteotomes, Chisels and Gouges with HARTPRESS -handle

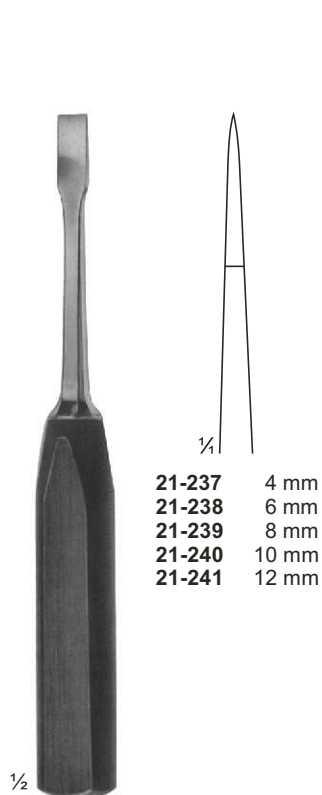

- 21-237 4 mm
- 21-238 6 mm
- 21-239 8 mm
- 21-240 10 mm
- 21-241 12 mm

LEXER-MINI
21-237 - 241
Osteotomes
180 mm

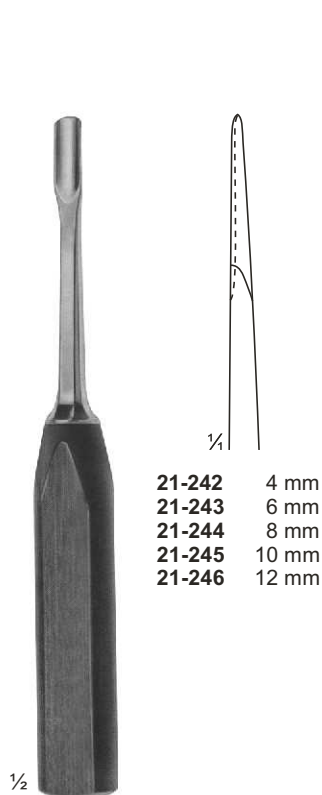

- 21-242 4 mm
- 21-243 6 mm
- 21-244 8 mm
- 21-245 10 mm
- 21-246 12 mm

LEXER-MINI
21-242 - 246
Gouges
180 mm

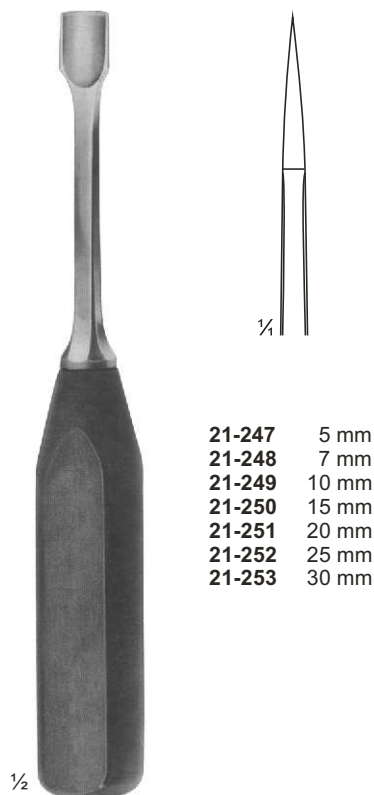

- 21-247 5 mm
- 21-248 7 mm
- 21-249 10 mm
- 21-250 15 mm
- 21-251 20 mm
- 21-252 25 mm
- 21-253 30 mm

LEXER
21-247 - 253
Osteotomes
220 mm

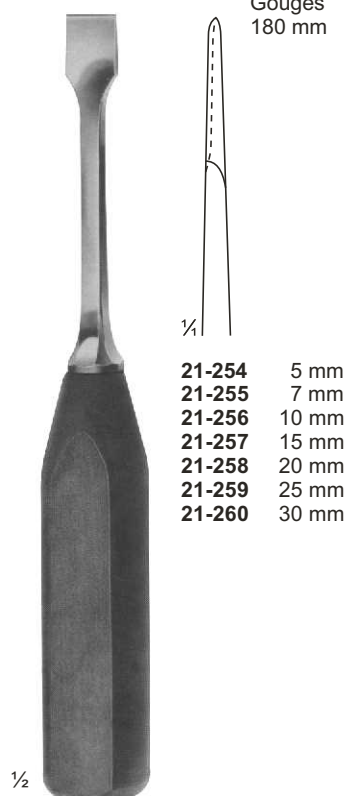

- 21-254 5 mm
- 21-255 7 mm
- 21-256 10 mm
- 21-257 15 mm
- 21-258 20 mm
- 21-259 25 mm
- 21-260 30 mm

LEXER
21-254 - 260
Gouges
220 mm

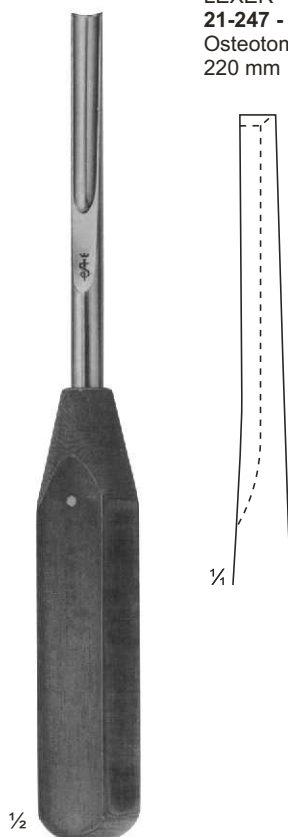

LEXER
21-261
Gouge for
removing broken
screws
220 mm

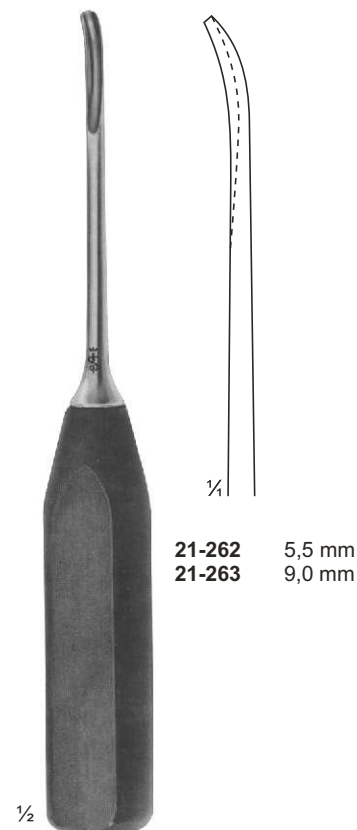

- 21-262 5,5 mm
- 21-263 9,0 mm

ZIELKE
21-262 - 263
Gouge for
scoliose-operations
230 mm

Osteotomes ,Chisels and Gouges with HARTPRESS -handle

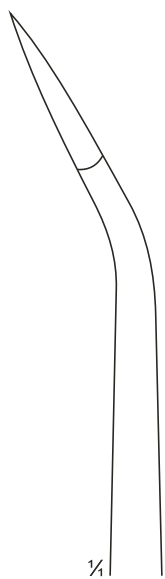

21-264 10 mm
21-265 15 mm

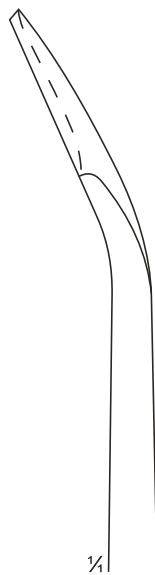

21-266 10 mm
21-267 15 mm

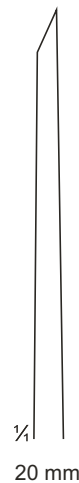

20 mm



16 mm

LEXER
21-264 - 265
Osteotomes,
angled
275 mm

LEXER
21-266 - 267
Gouges,
angled
275 mm

21-268
Chisel
245 mm

21-269
Chisel, curved
265 mm

Reposition Forceps



22-101
Reposition forceps,
for small fragments
135 mm

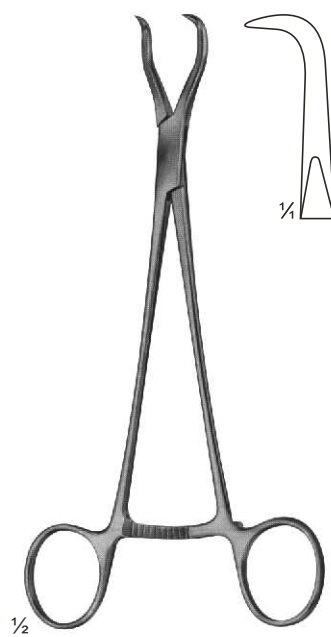

HAASE
22-102
Reposition forceps,
for mandibular
fractures
165 mm

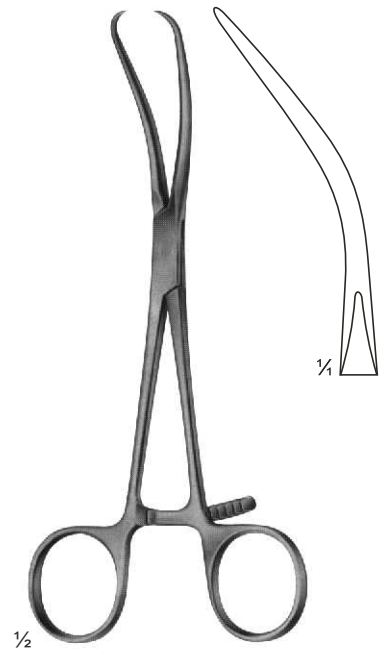

REILL
22-103
Reposition forceps,
170 mm



22-104
Reposition forceps
205 mm

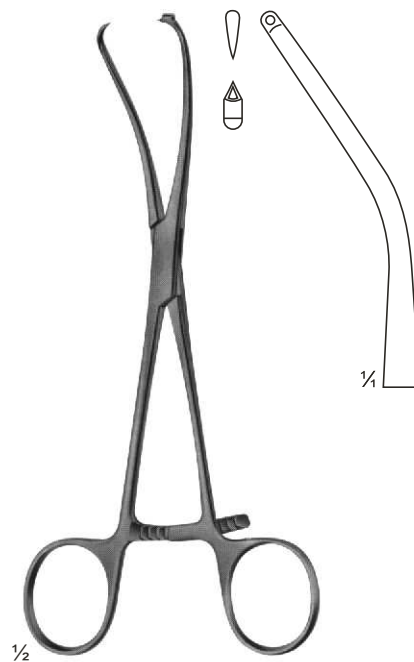
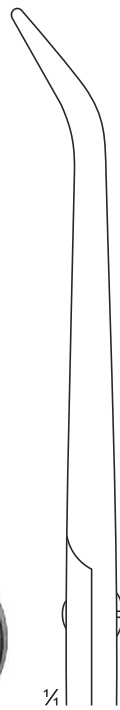

MEYER
22-105
Reposition forceps
for fingers, with drill
guide for KIRSCHNER
wires up to daim.1.0 mm
170 mm

Reposition Forceps, Bone Holding Forceps



22-106
Patella forceps
185 mm



22-107
Forceps with
ratchet fixation
140 mm



22-108
Forceps with
thread fixation
170 mm



22-109
Forceps with
thread fixation
235 mm

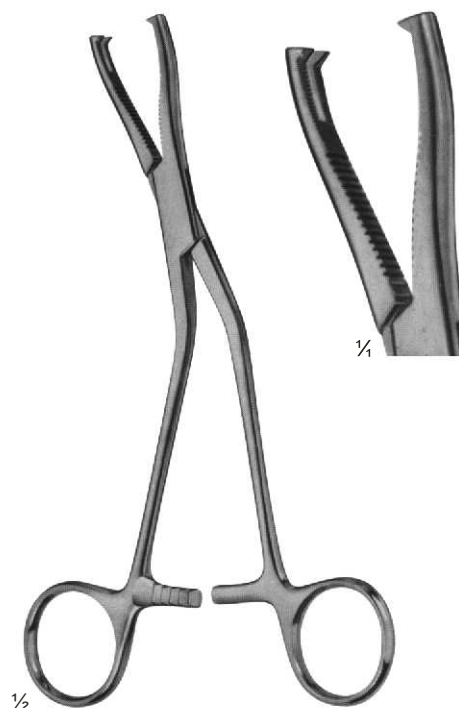

22-110
DINGMANN
185 mm

Bone Holding Forceps



22-111
Sequestrum
forceps
200 mm



22-112
VAN BUREN
Sequestrum
forceps
225 mm



22-113
LANGENBECK
Sequestrum
forceps
205 mm



22-114
FERGUSSON
Sequestrum
forceps
205 mm

Bone Holding Forceps

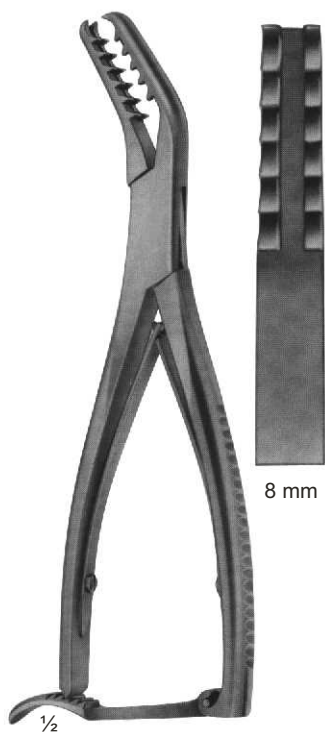
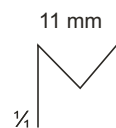
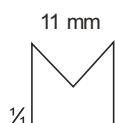
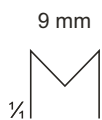
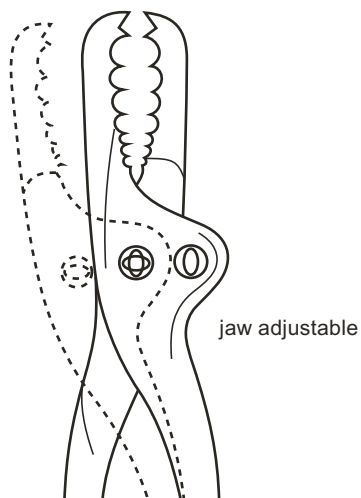

22-115
SEMB
190 mm



22-116
FARABEU
230 mm

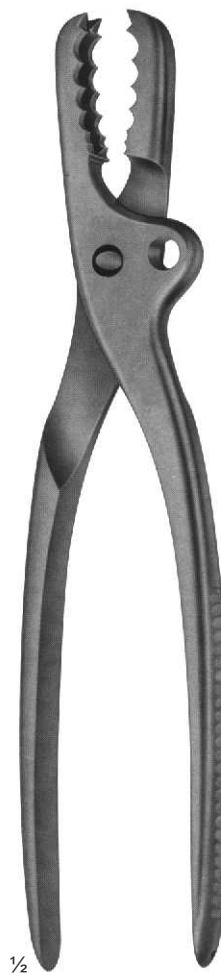

22-117
FARABEU
255 mm



22-118
FARABEU-LAMBOTTE
255 mm

Bone Holding Forceps



22-119
KERN-LANE
240 mm

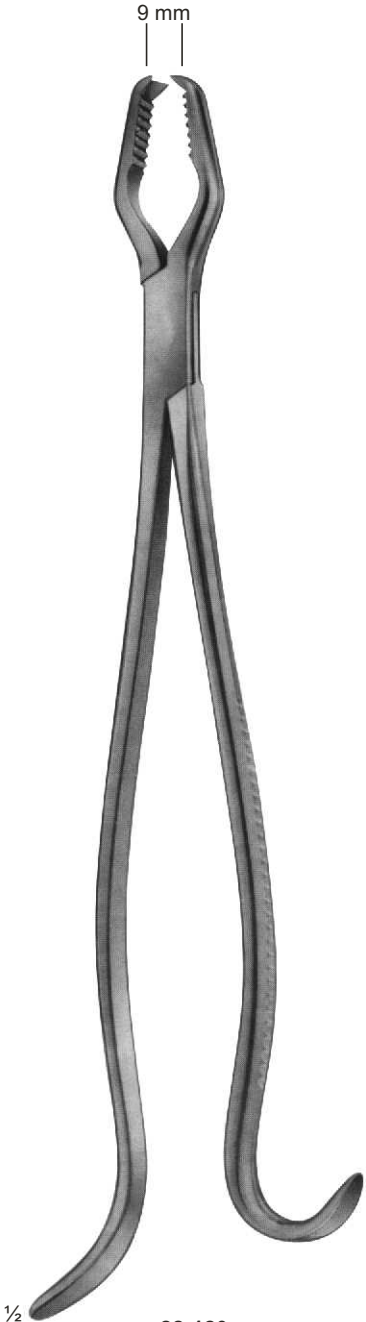

22-120
LANE
330 mm



22-121
KERN-LANE
240 mm

Bone Holding Forceps



22-122
LANE
320 mm



22-123
HEY GROVES
305 mm

Bone Holding Forceps



22-124 - 128

- 22-124 145 mm
- 22-125 190 mm
- 22-126 240 mm
- 22-127 260 mm
- 22-128 280 mm

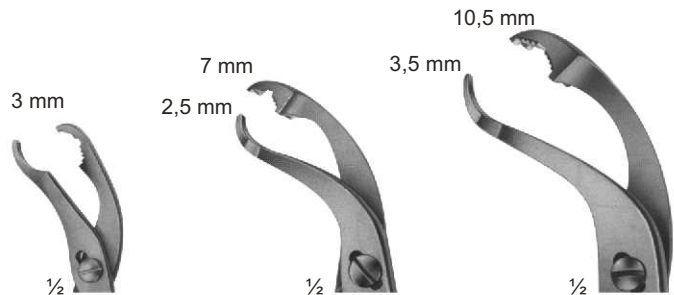

22-124 for small fragments

22-125 Fig: 0

22-126 Fig: 1

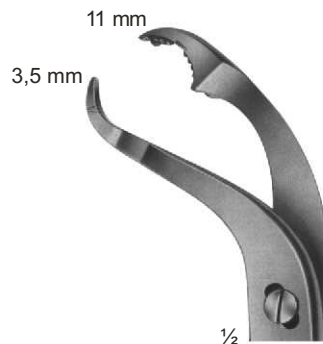

22-127 Fig: 2

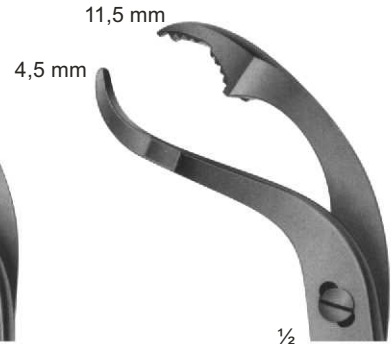

22-128 Fig: 3

Self-centering forceps with thread fixation



1/2

22-129 - 131 VERBRUGGE with lip joint

- 255 mm
- 265 mm
- 270 mm

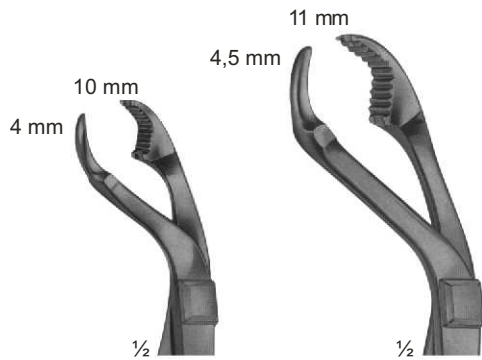

22-129 Fig: 1

22-130 Fig: 2

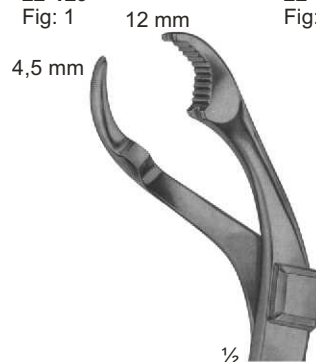

22-131 Fig: 3



1/2

22-132 LAMBOTTE 265 mm

Bone Clamps



½
22-133 - 134
LOWMAN
22-133 170 mm
22-134 205 mm



½
22-135
LOWMAN-GERSTER
210 mm



½
22-136
LOWMAN-HOGLUND
175 mm

Synovectomy-Rongeurs, Bone Rongeurs

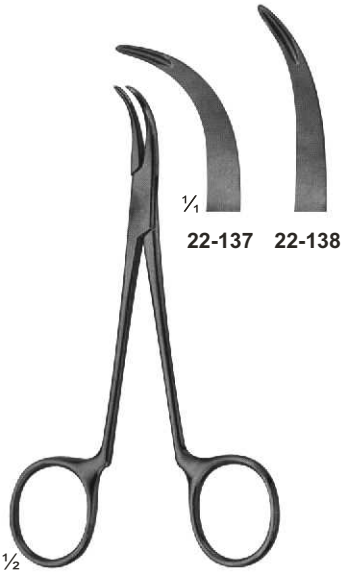

22-137 - 138
Synovcetomy rongeur
width of jaws 1.2 mm
130 mm

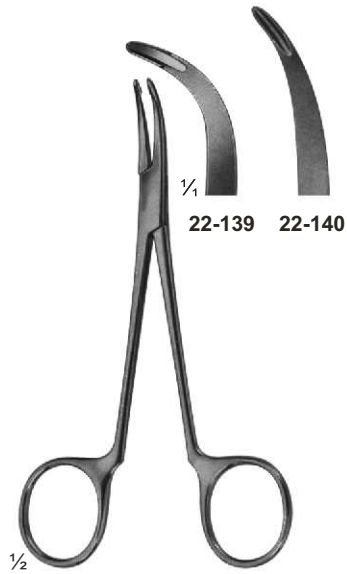

22-139 - 140
Synovcetomy rongeur
width of jaws 2.0 mm
130 mm

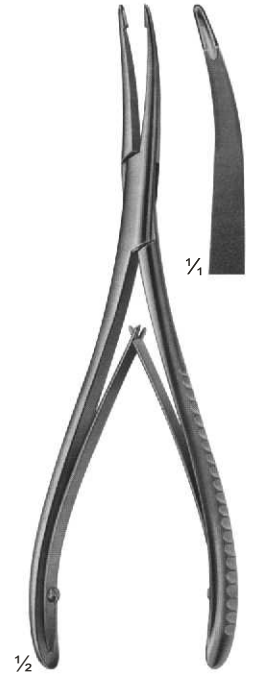

22-141
STELLBRINK
Synovectomy rongeur
175 mm

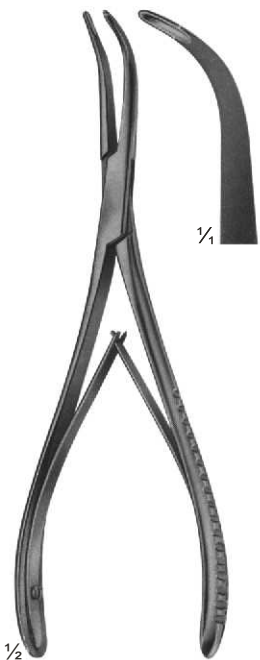

22-142
STELLBRINK
Synovectomy rongeur
170 mm

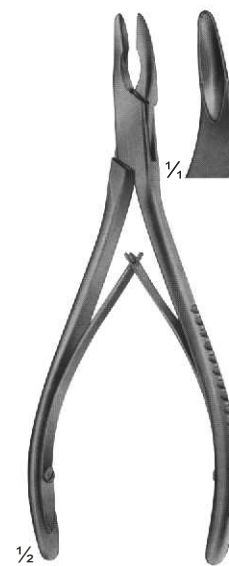

22-143
LURE-FRIEDMANN
145 mm

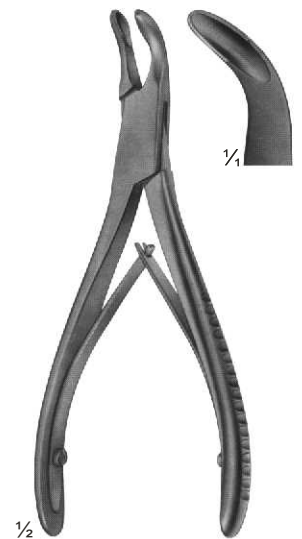

22-144
140 mm

Bone Rongeurs



22-145
LURE
150 mm

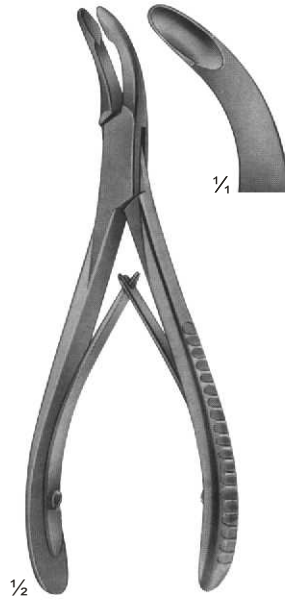

22-146
LURE
155 mm

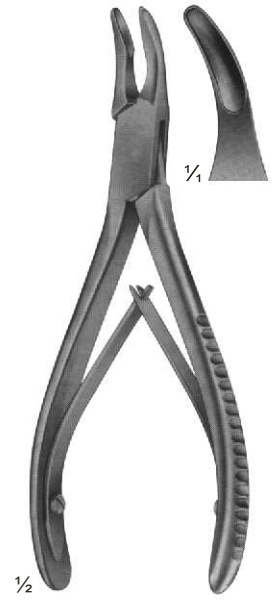

22-147
BLUMENTHAL
155 mm

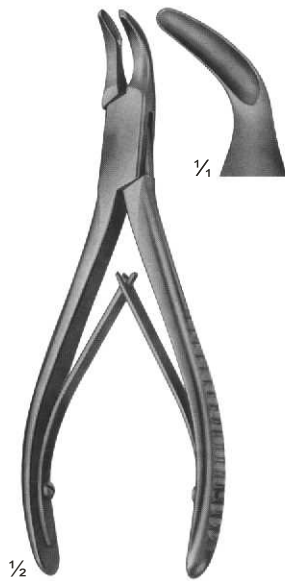

22-148
BLUMENTHAL
150 mm

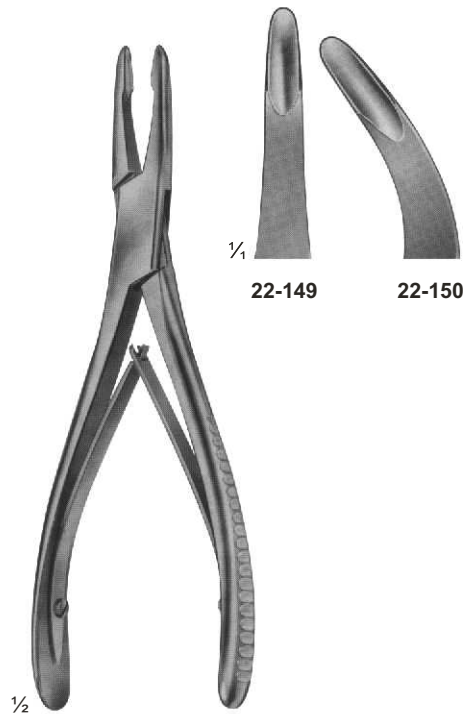

22-149 - 150
JANSEN
175 mm

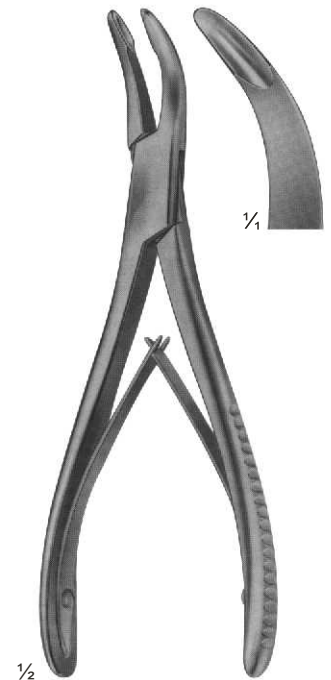

22-151
BANE-HARTMANN
175 mm

Bone Rongeurs

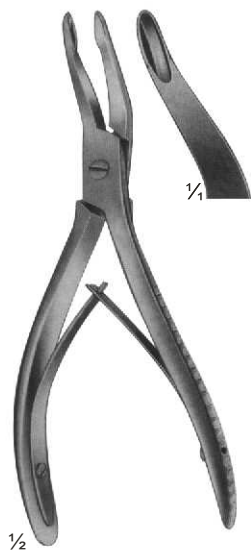

22-152
ALEXANDER
140 mm

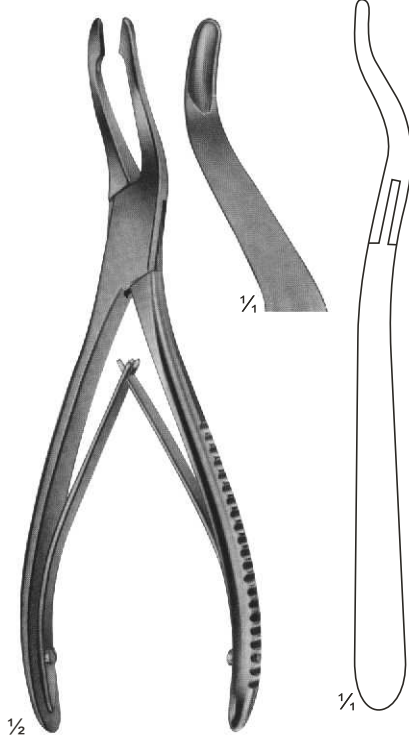

22-153
JANSEN
190 mm

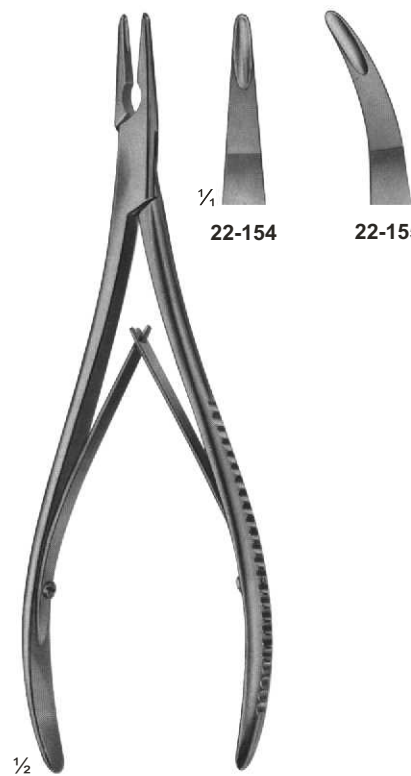

22-154 - 155
LEMPERT
200 mm

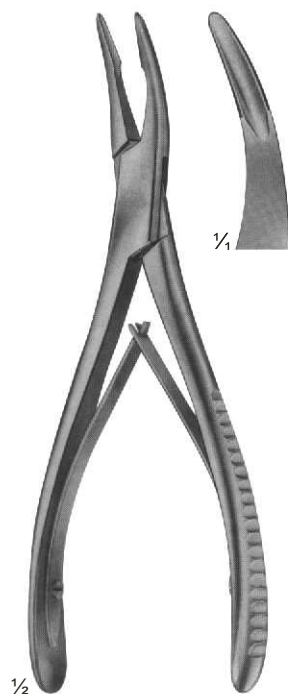

22-156
BEYER
180 mm

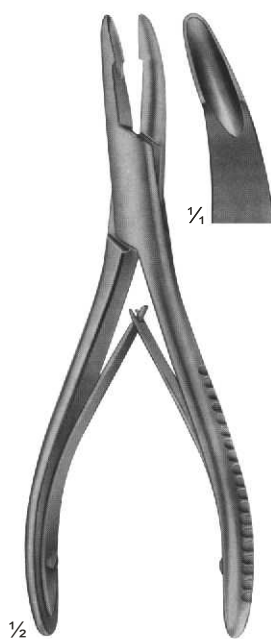

22-157
MEAD
165 mm

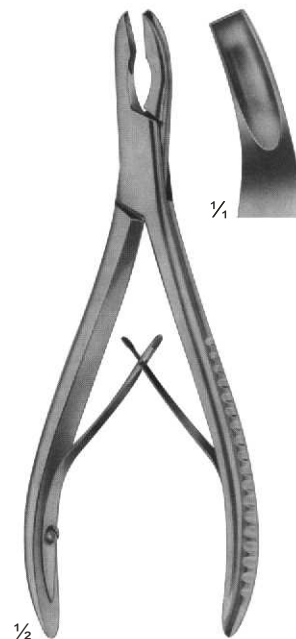

22-158
MEAD
165 mm

Bone Rongeurs

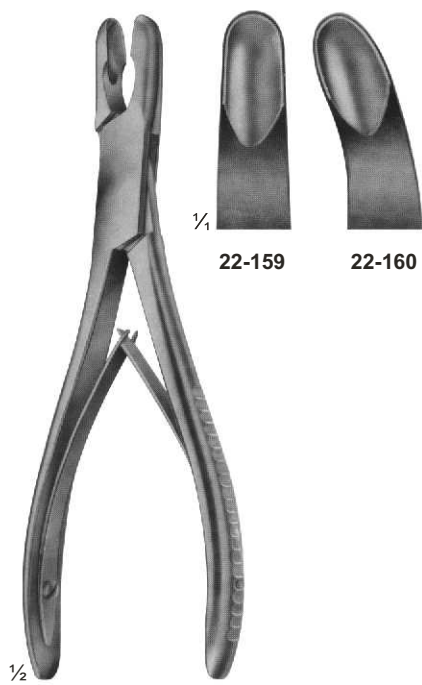

22-159 22-160

22-159 - 160
LURE
175 mm

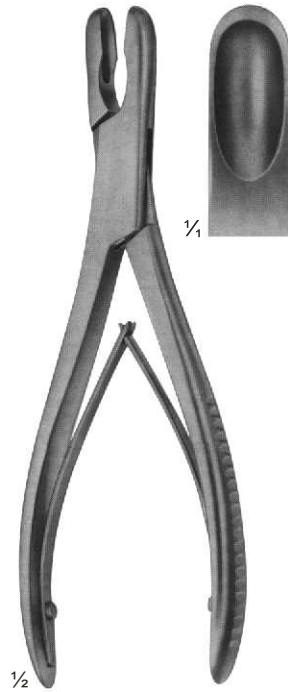

22-161
LURE
180 mm

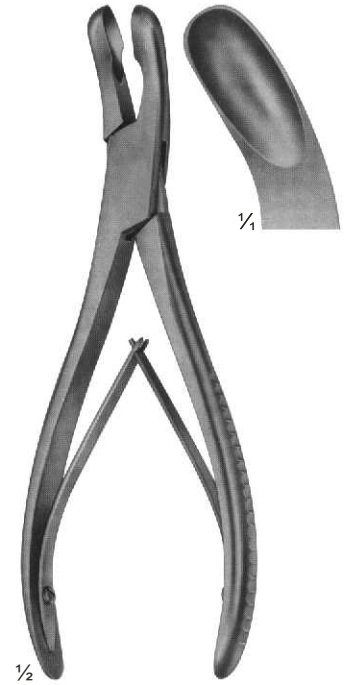

22-162
LURE
180 mm

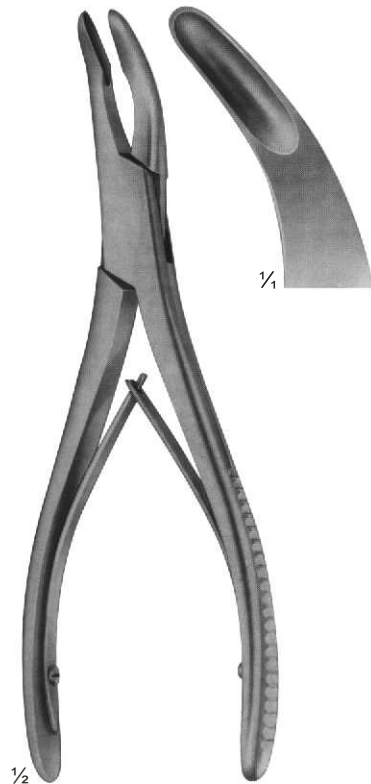

22-163
OLIVECRONA
205 mm



22-164 - 165
BOHLER
155 mm

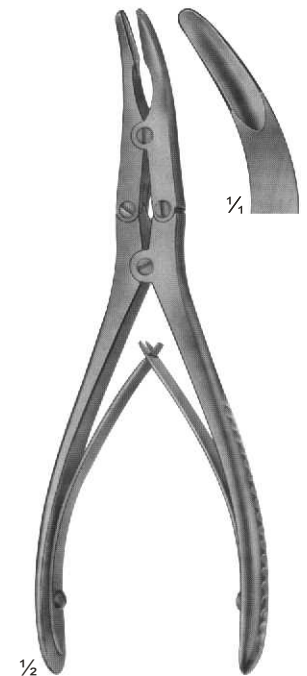

22-166
MARQUARTD
200 mm

Bone Rongeurs

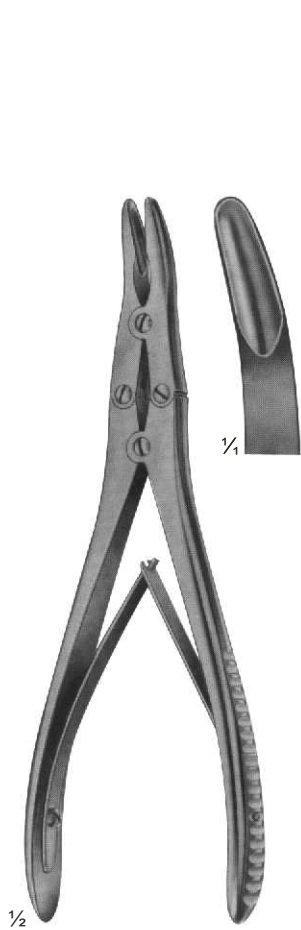

22-167
RUSKIN
190 mm



22-168
ROTTGEN-RUSKIN
240 mm

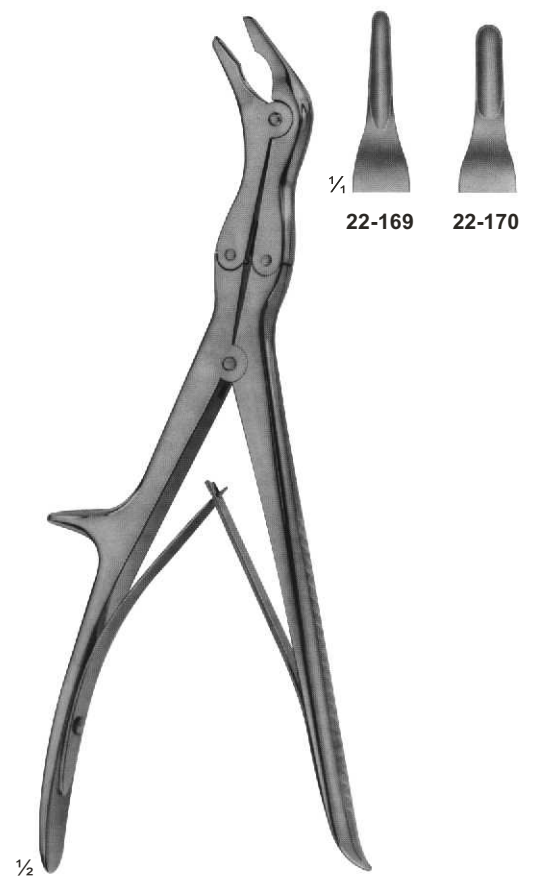

22-169 - 170
ECHLIN
230 mm

Bone Rongeurs



22-171
STILLE
235 mm



22-172
LEKSELL-STILLE
240mm



22-173
STILLE-RUSKIN
240mm

Bone Rongeurs



22-174
LURE-STILLE
225 mm



22-175
LURE-STILLE
225 mm

Vena-Cava Clamps

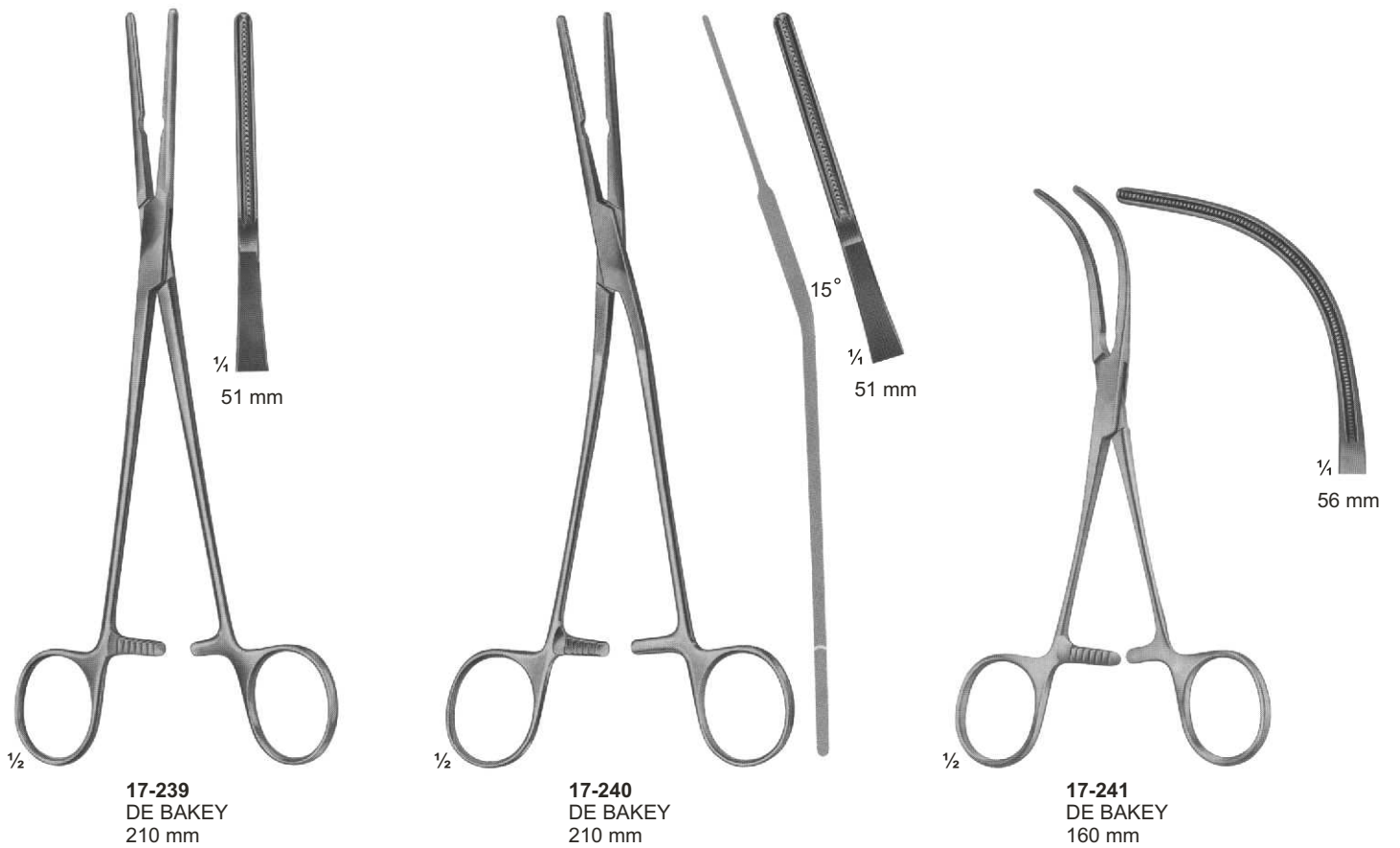
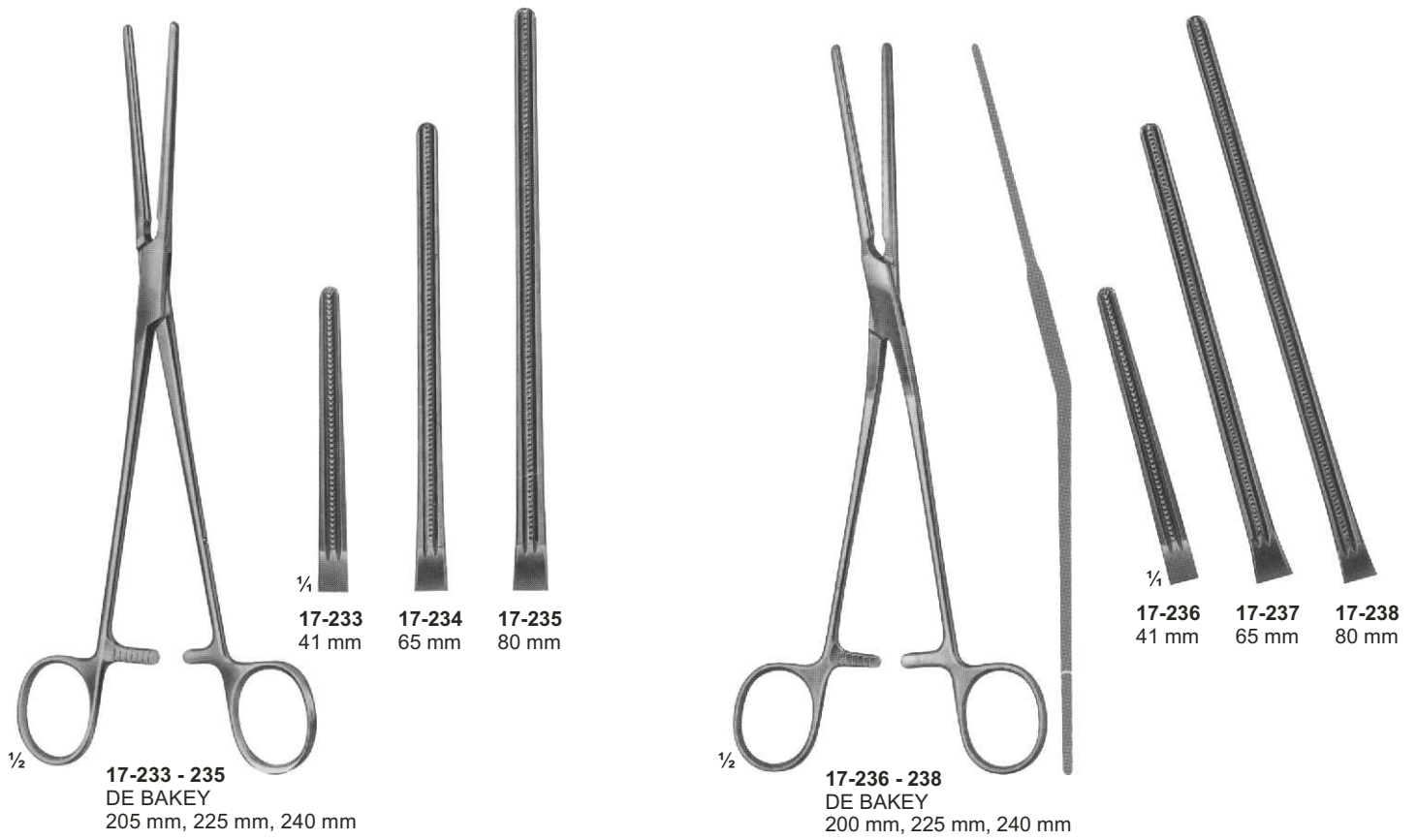

Bone Cutting Forceps

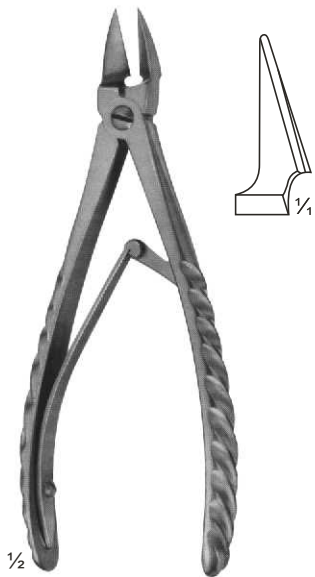

22-178
STAMM
150 mm



22-179
KAZANJIAN
185 mm

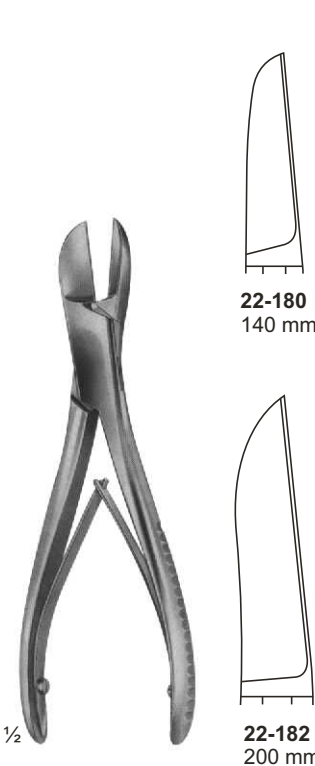

22-180 - 183
LISTON



22-180
140 mm

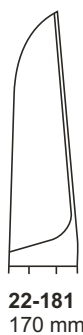

22-181
170 mm



22-182
200 mm

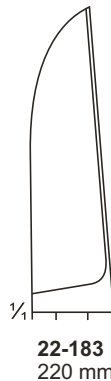

22-183
220 mm

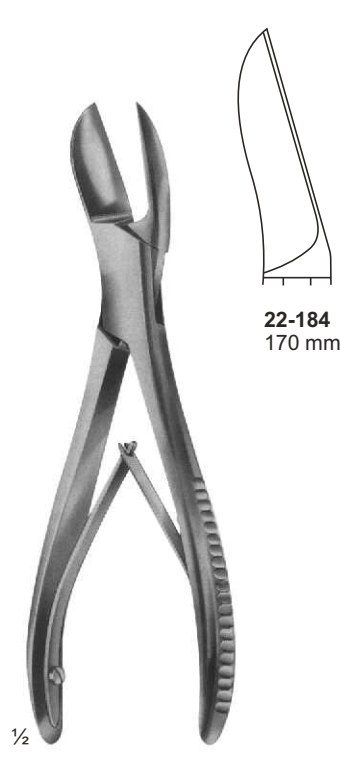

22-184 - 186
LISTON



22-184
170 mm

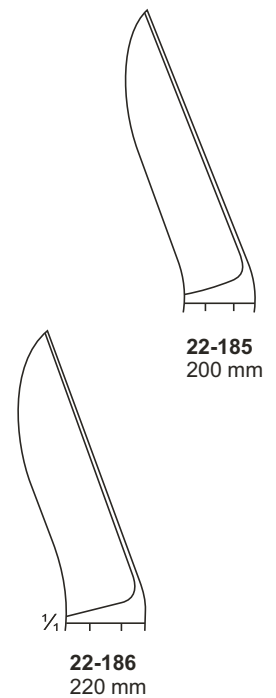

22-185
200 mm



22-186
220 mm

Bone Cutting Forceps



22-187
BOHLER
145 mm

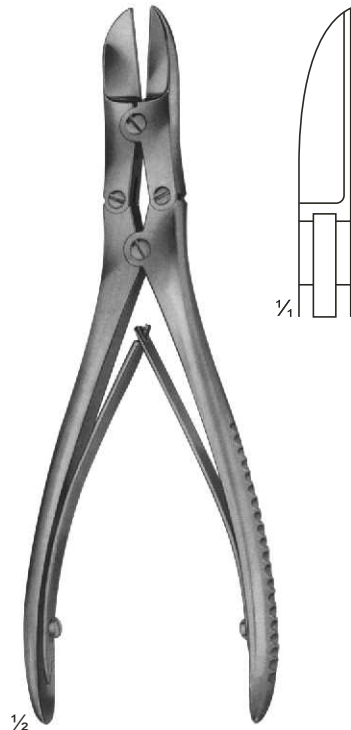

22-188
RUSKIN-LISTON
190 mm

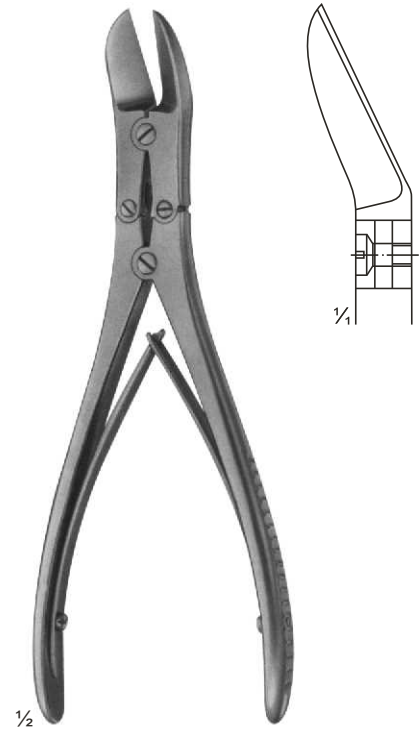

22-189
RUSKIN-LISTON
190 mm

Bone Cutting Forceps

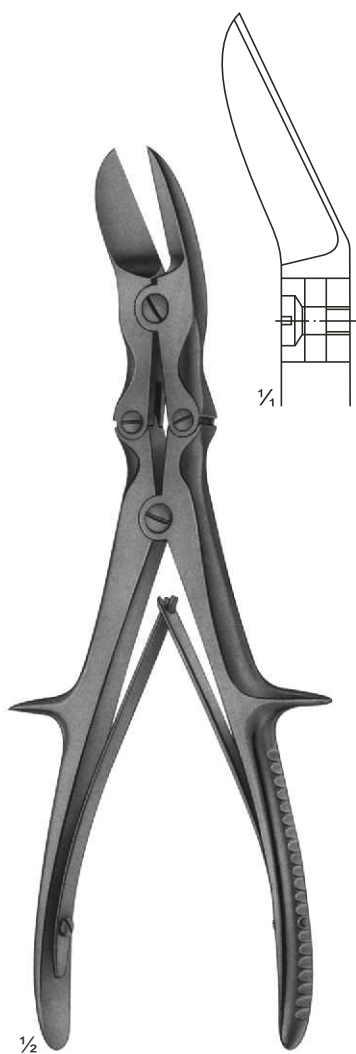

22-190
LISTON
curved on flat
240 mm

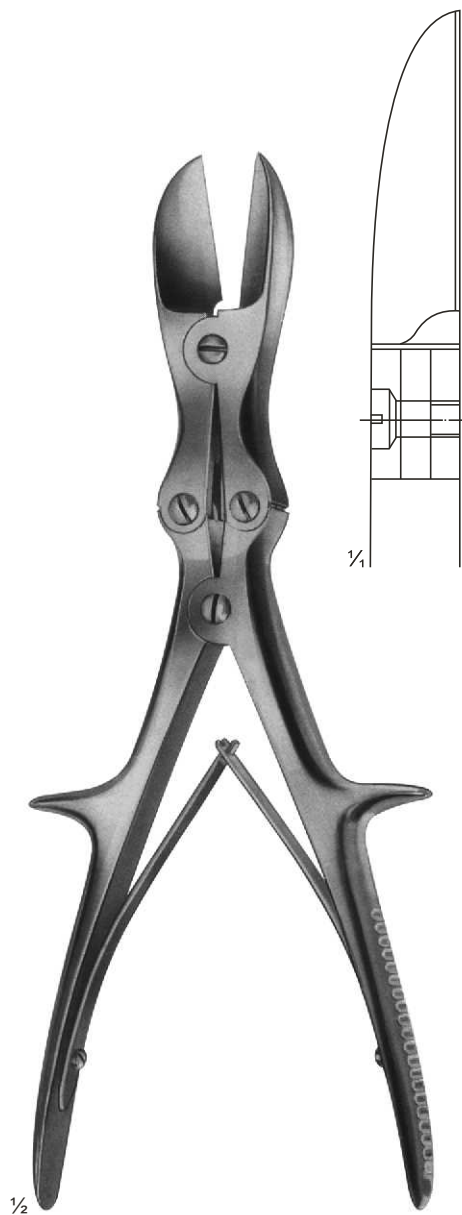

22-191
LISTON
straight
280 mm

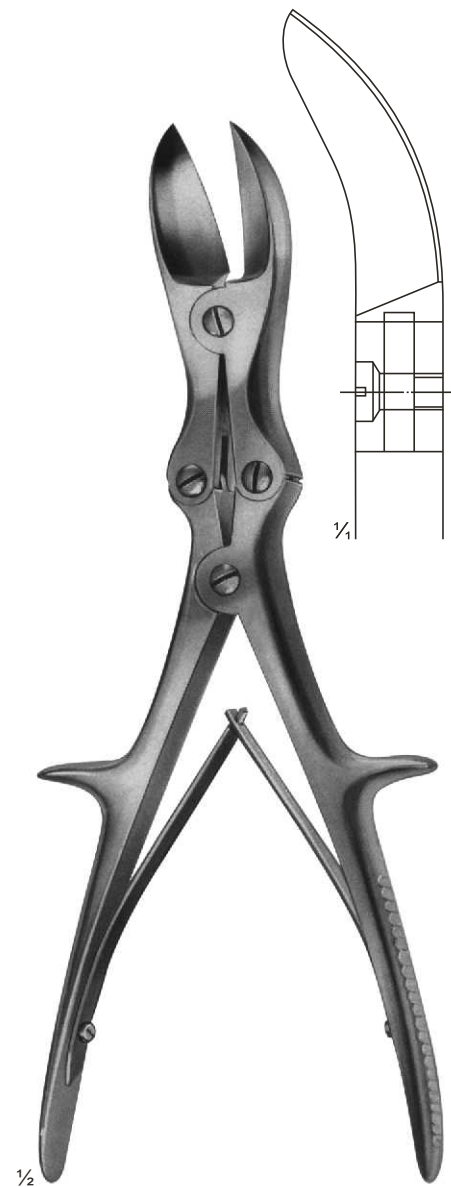

22-192
LISTON
curved on flat
280 mm

Bone Cutting Forceps

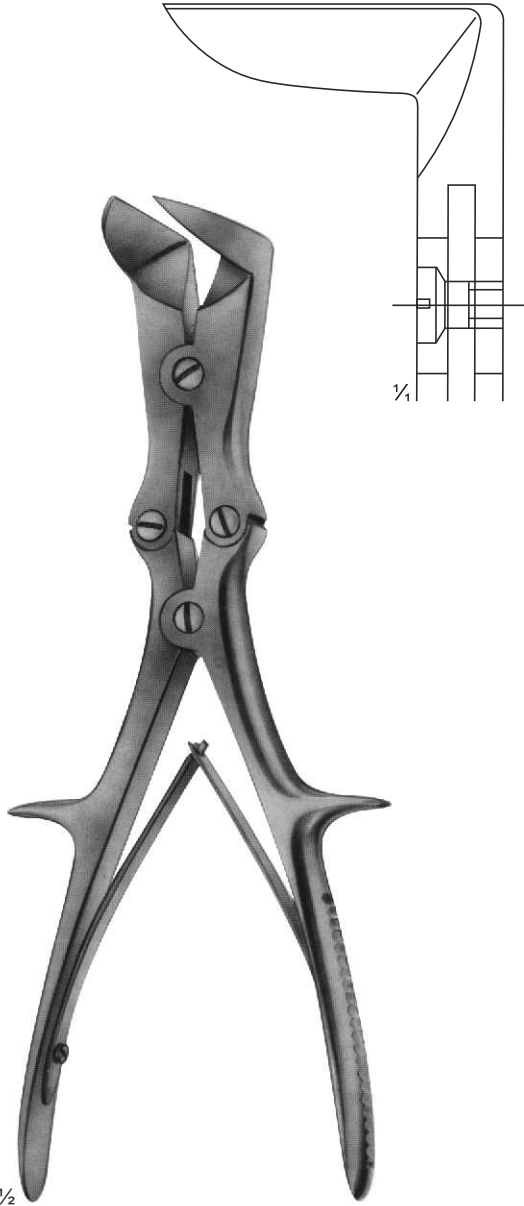

22-193
LISTON-STILLE
265 mm

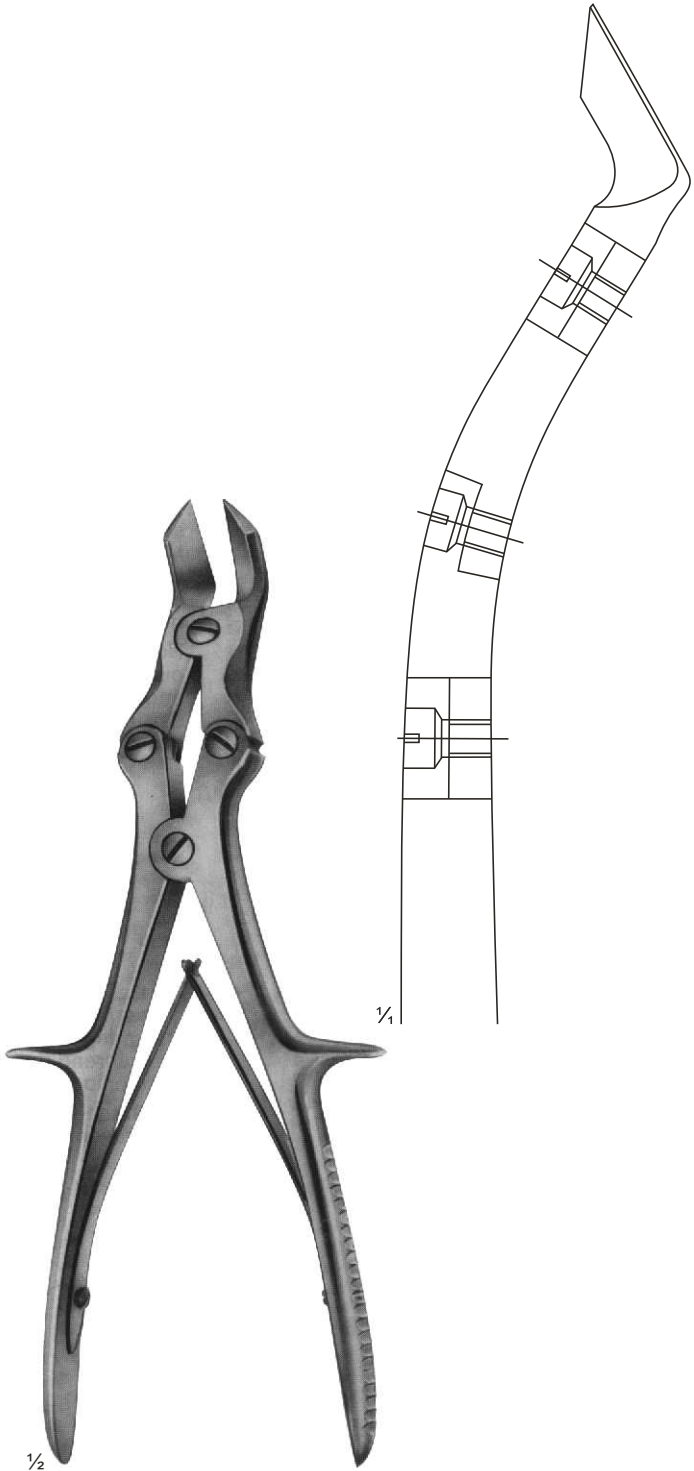

22-194
LISTON-KEY-HORSLEY
(TUDOR EDWARDS)
255 mm

Meniscus-and Cartilage Forceps



22-195
BIRCHER
200 mm

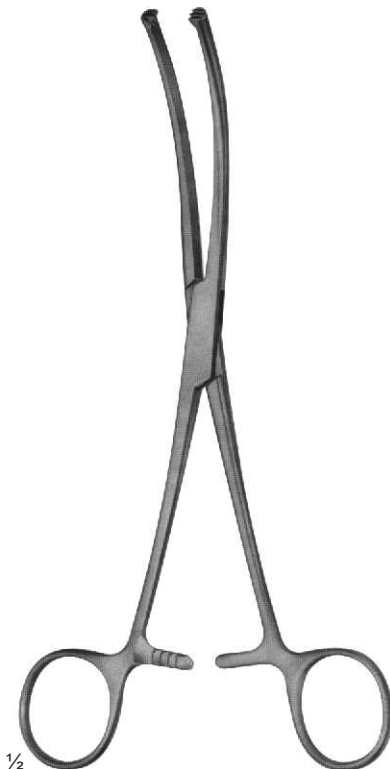

22-196
BIRCHER
200 mm

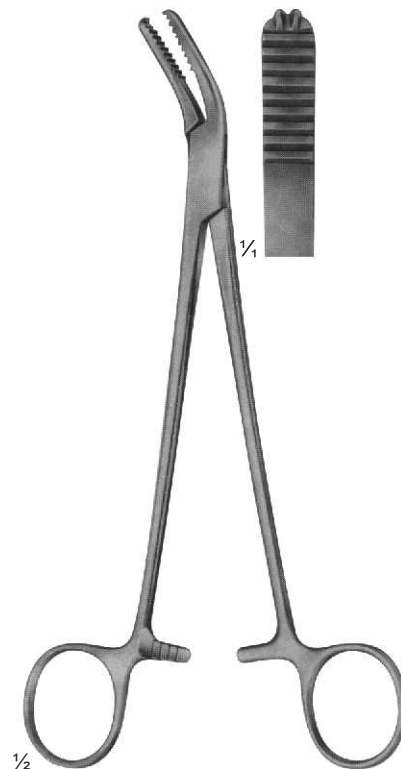

22-197
WELLER
200 mm

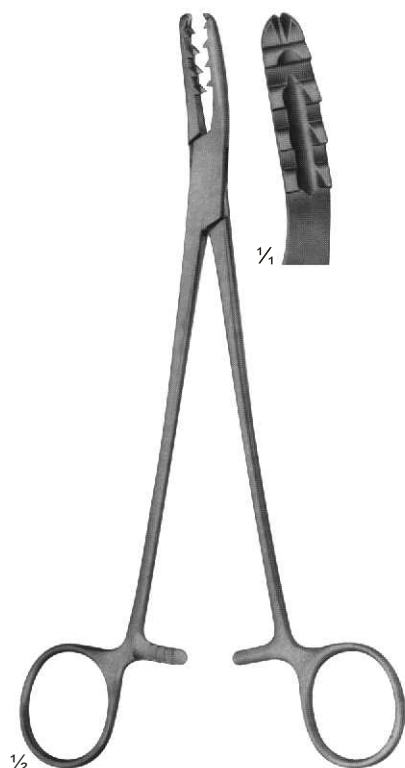

22-198
BIRCHER-GANSKE
200 mm

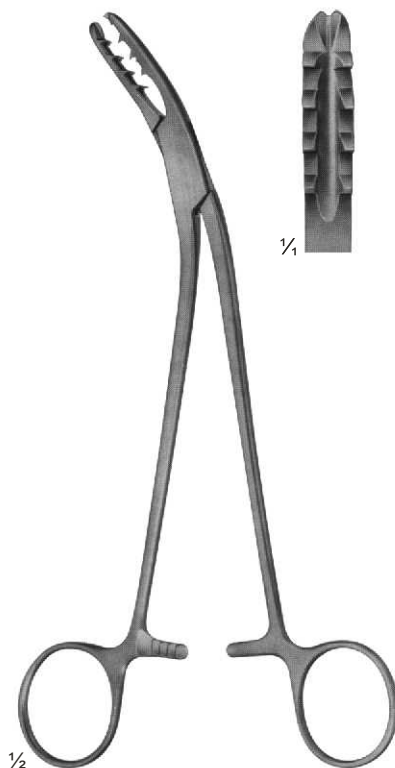

22-199
BIRCHER-GANSKE
200 mm



22-200
MARTIN
205 mm

Meniscus Knives

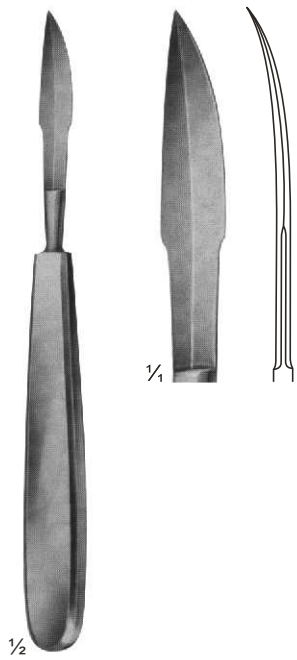

22-201
170 mm

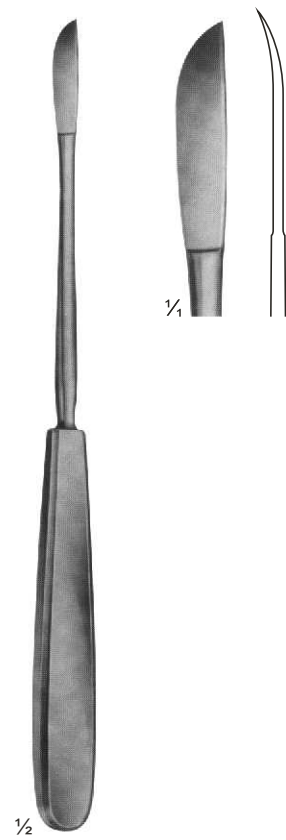

22-202
NEFF
215 mm

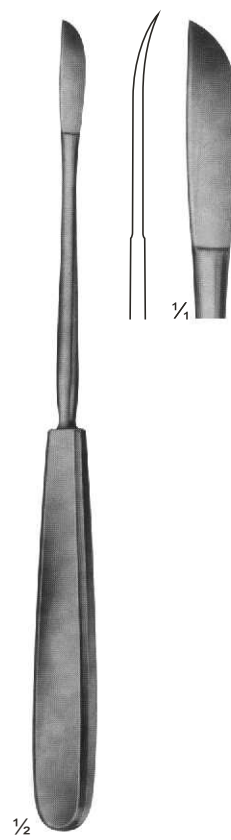

22-203
NEFF
215 mm

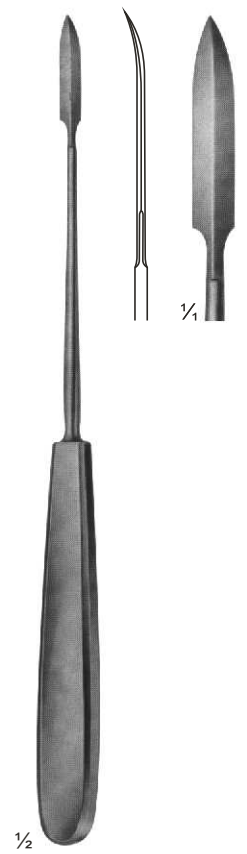

22-204
WAGNER
215 mm

Meniscus Knives

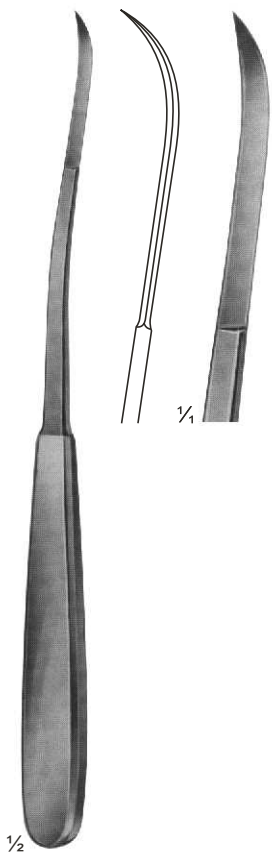

22-205
SALENIUS
220 mm

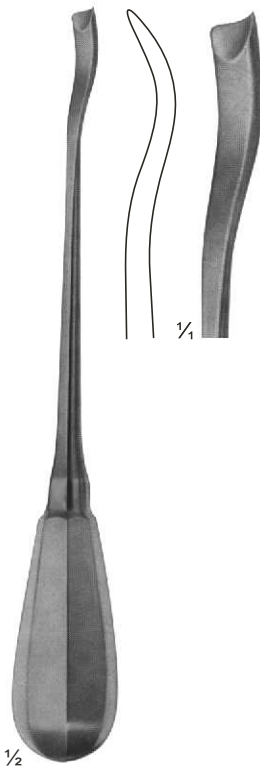

22-206
CHNAD.MODELL
200 mm

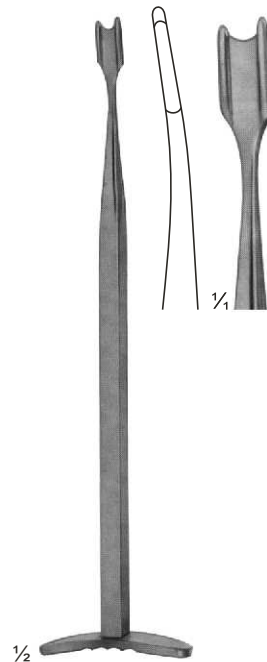

22-207
SMILLIE
170 mm

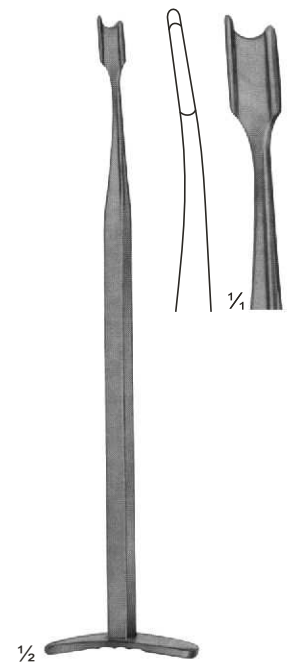

22-208
SMILLIE
170 mm

Wire Extension

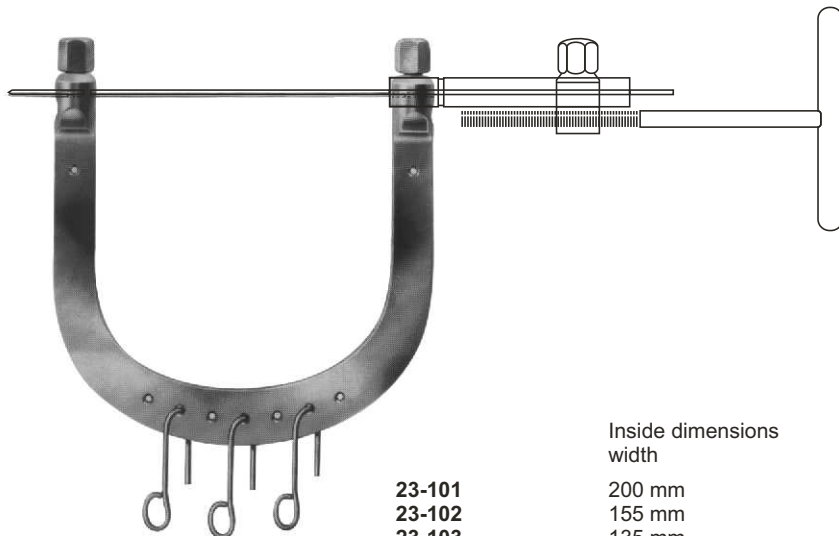

23-101 - 107
KIRSCHNER
Wire traction bows,
to be used with
KIRSCHNER-wires
up to 2.5 mm diam.,
With 3 hooks,
stainless steel

- 23-101
- 23-102
- 23-103
- 23-104
- 23-105
- 23-106
- 23-107

Inside dimensions	width	depth
23-101	200 mm	155 mm
23-102	155 mm	155 mm
23-103	135 mm	130 mm
23-104	120 mm	120 mm
23-105	105 mm	100 mm
23-106	95 mm	110 mm
23-107	95 mm	70 mm



23-108
Wrench, double - ended,
for wire traction bows



23-109
Wire tightener, with
clamping jaws



1/3

23-110
Traction hook only,
large size



1/3

23-111
Traction hook only,
small size



1/3

23-112
Fixation clamp, to secure clamping
jaws of stainless steel

Wire Extension

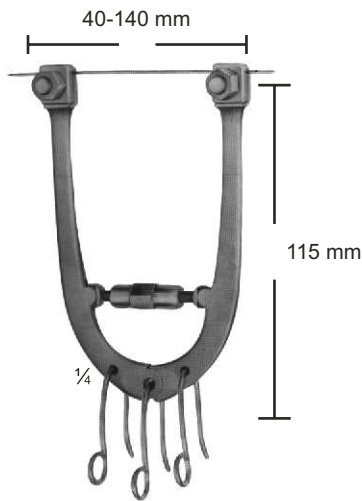

23-113
Wire traction bow, adjustable,
with 3 hooks, small size

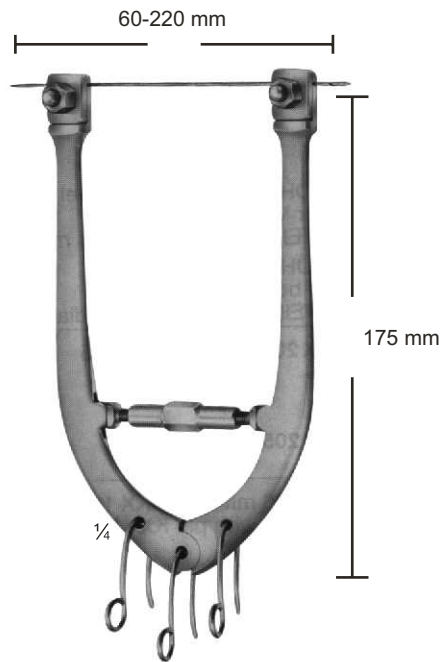

23-114
Wire traction bow, adjustable,
with 3 hooks, large size

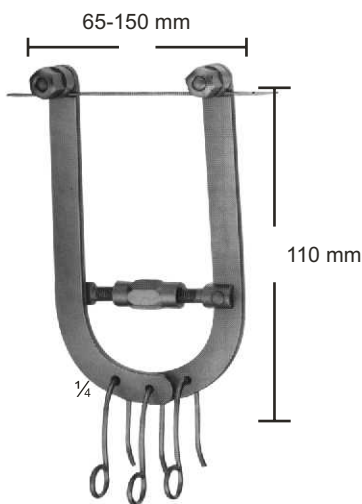

23-115
Wire traction bow, adjustable,
with 3 hooks, large size for
elbow and calcaneus, for
adolescents



23-116	105 mm
23-117	160 mm
23-118	200 mm
23-116	1,6 mm
23-117	2,0 mm
23-118	2,5 mm

23-116 - 118
KIRSCHNER
Wire traction bow, modified
adjustable in with width, holds wire
securely, with 1 hook



23-119
Fixation disc, slotted



23-120
idem, aluminum, transparent
to X-rays



23-121
Fixation disc, slotted



23-122
Screw driver, for above
fixations discs

Traction Bows, Distractor

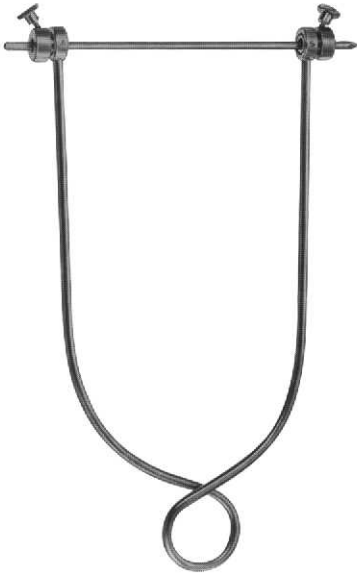

23-123 - 130
Screw driver, for above
fixations discs

Steinmann pins, 4 mm daim.	Steinmann pins, 5 mm daim.
23-123 with pin	16x9cm Arm
23-124 without pin	23-129 without
23-125 with pin	21x11cm Arm
23-126 without pin	23-130 without
23-127 with pin	21x15cm Arm
23-128 without pin	



23-131
SCHWARZ
Traction bow for fingers,
to be used with KIRSCHNER-
wire up to 1.6 mm diam.

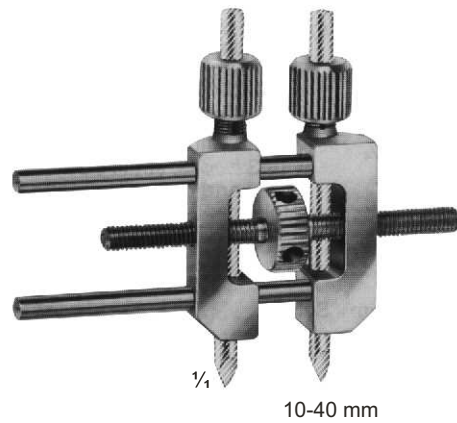

23-132
Small distractor
as a repositioning device for
distraction and compression of small bones,
for wires with 3.0 mm diam.

STEINMANN Pins



23-133 - 147
STEINMANN
triangular shaft ended and trocar point

Length	4,0 mm	5,0 mm
80 mm	23-133	
100 mm	23-134	
120 mm	23-135	
140 mm	23-136	
150 mm	23-137	23-143
160 mm	23-138	
180 mm	23-139	23-144
200 mm	23-140	23-145
210 mm	23-141	
250 mm	23-142	23-146
300 mm		23-147



23-148
Protection cap
for 4,0 mm STEINMANN Pins



23-149
Protection cap
for 5,0 mm STEINMANN Pins

Drilling Chucks



1/2

23-150
REILL
Drilling chuck, cannulated, for shanks from 2.0 - 2.5 mm diam 115 mm



1/2

23-151
Drilling chuck, cannulated, for shanks from 0.8 - 2.0 mm diam 150 mm



1/2

23-152
Drilling chuck, cannulated, for shanks up to 4.5 mm diam with key 140 mm



1/2

23-153
LOUTE
Wire tightener, improved pattern, with movable tip, for wires up to 1.0 mm diam. 220 mm



1/2

23-154
Drilling chuck, cannulated, for shanks up to 6.35 mm diam., To be tightened by hand 100 mm



1/2

23-155
Drilling chuck, cannulated, for shanks up to 4.5 mm diam., And for triangular shaft width across flats 4.7 mm



1/2

23-156
Drilling chuck, cannulated, for shanks up to 6.35 mm diam., With key 160 mm

Cerclage Instruments

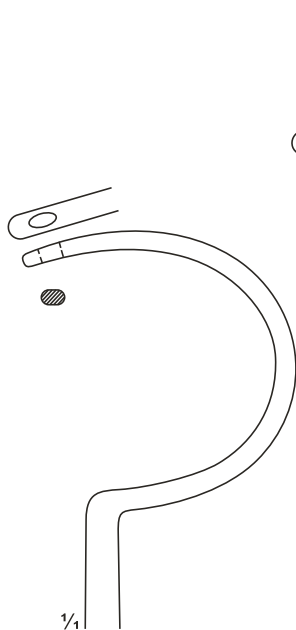

23-157
275 mm

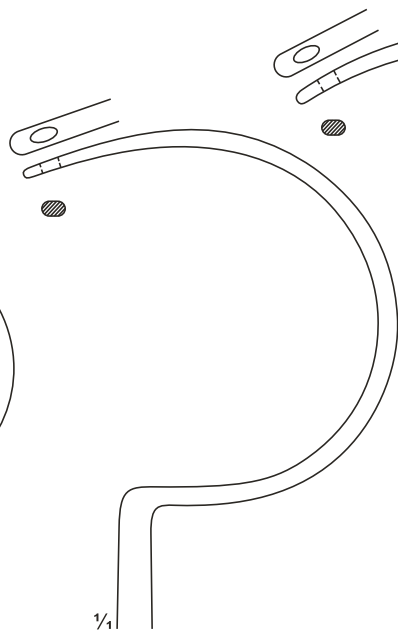

23-158
285 mm

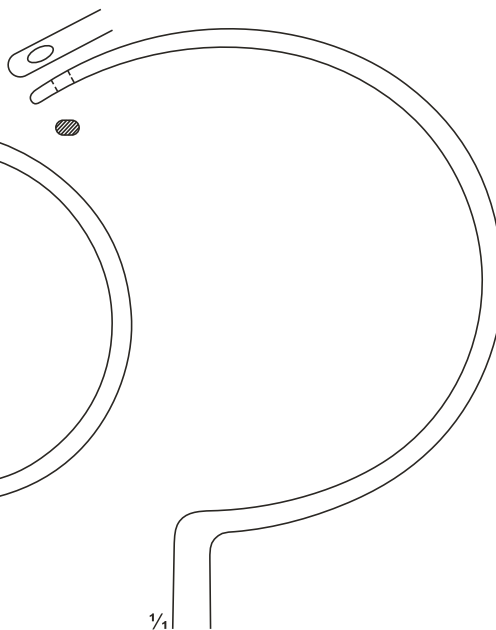

23-159
305 mm



23-157 - 159
DEMEL
Wire guides

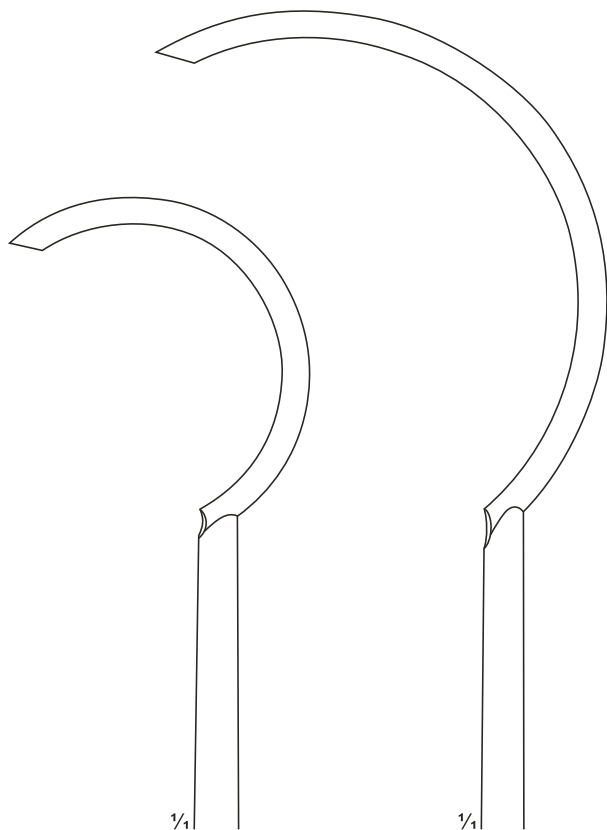

23-160
240 mm



23-161
270 mm

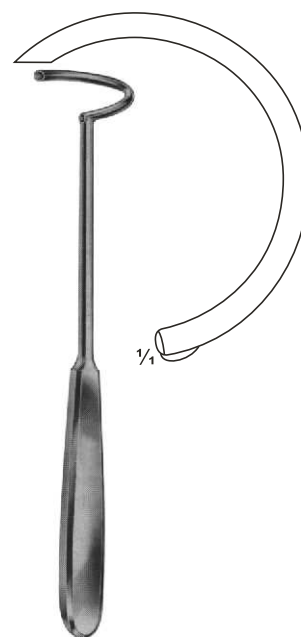

23-162
225 mm

JORDAN instruments for subcutaneous Tibia Cerclage



23-163
JORDAN
Wire tightener



1/2

23-164
JORDAN
Wire twister
170 mm



1/2

23-165
JORDAN
Wire catcher
180 mm



1/2

23-166
JORDAN
Probe, cannulated
170 mm

Wire Holding forceps, Wire Tightening Pliers, Flat-nosed Pliers

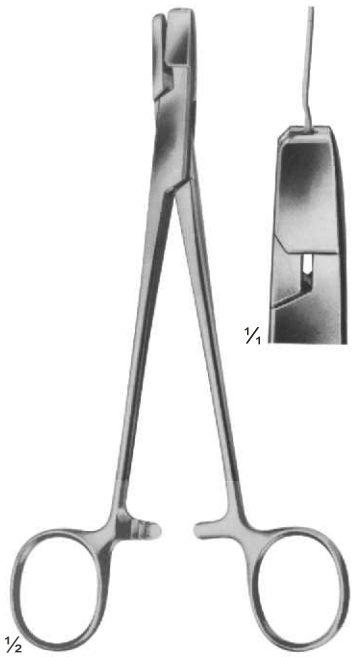

23-167
DUROGRIP
Holding forceps for cerclage wire, with lateral jaws to avoid wire slipping off
170 mm



23-168
DUROGRIP
Wire, tightening pliers, Ligature pliers
150 mm



23-169
DUROGRIP
Wire, tightening pliers, Ligature pliers
150 mm



23-170
with serrated jaws
140 mm



23-171
one jaws smooth, one jaws serrated
140 mm



23-172
with serrated jaws
23-173
with longitudinal and transversal grooves
170 mm

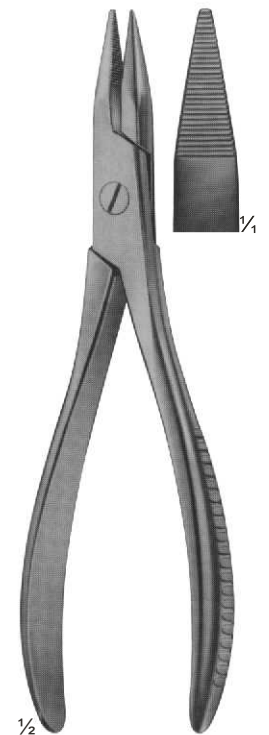

23-174
190 mm

Wire Holding forceps, Flat-nosed Pliers, Pliers for bending and cutting wires

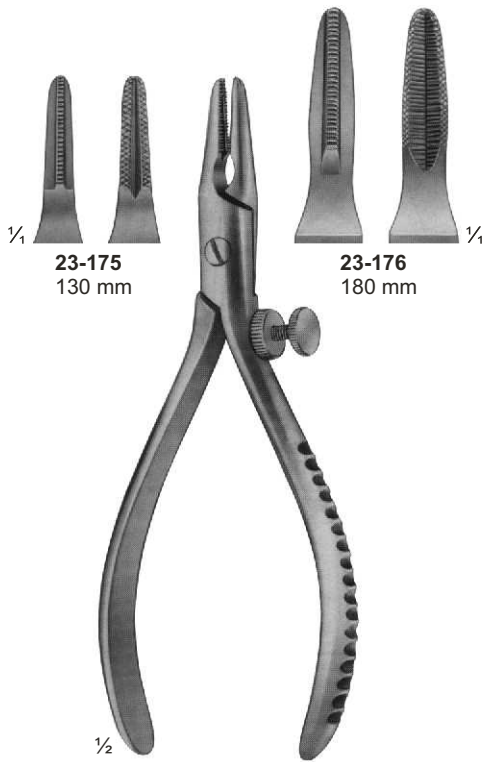

23-175 - 176
Extraction pliers
for boring wires

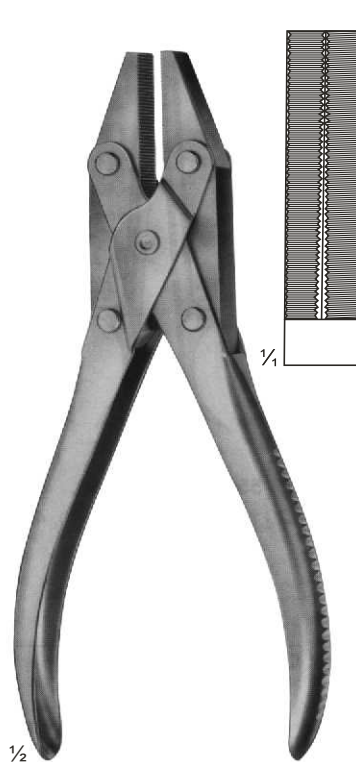

23-177
Flat-nosed pliers,
parallel
185 mm

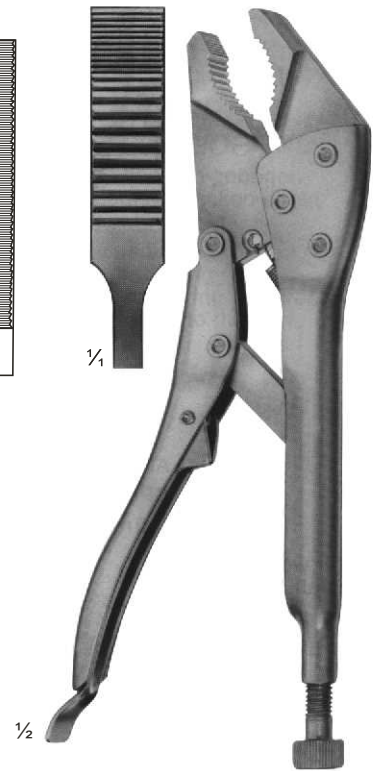

23-178
Vise grip
200 mm

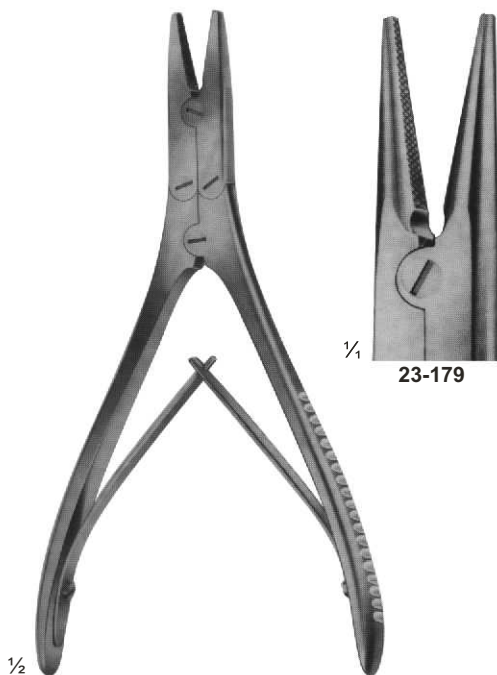

23-179 - 183
Round pliers
180 mm

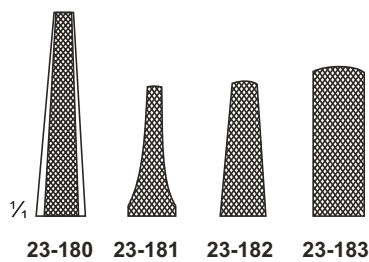

23-180
23-181 145 mm
23-182 180 mm
23-183 180 mm
Extraction pliers for wires

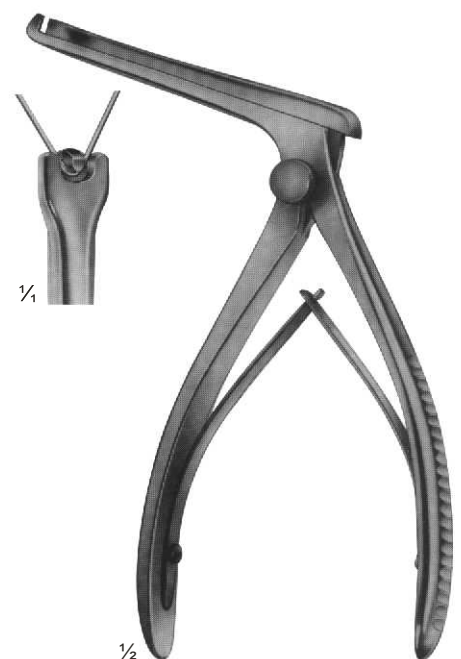

23-184
Bending pliers
for wires up to
1.8 mm diam.

Wire Cutters and wire Cutting Scissors

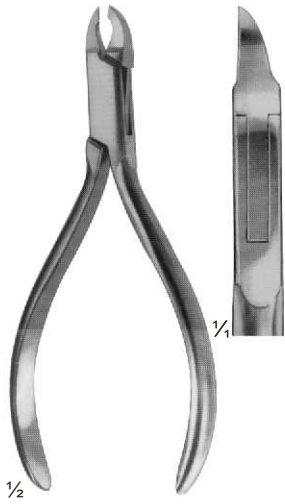

23-185
ANGLE
130 mm

for soft wire
up to diam.
for hard wire
up to diam.

23-186
DUROTIP
ANGLE
130 mm

0,5 mm 0,6 mm
0,3 mm 0,4 mm

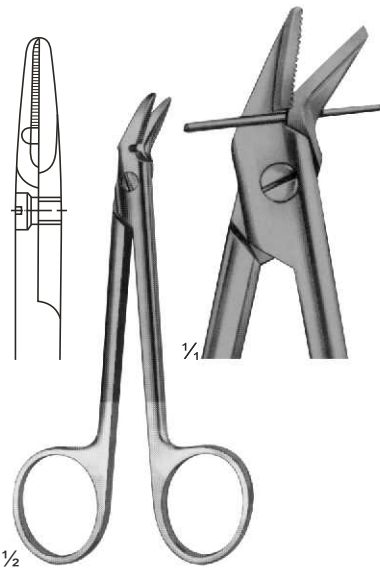

23-187
120 mm

for soft wire
up to diam.
for hard wire
up to diam.

23-188
DUROTIP
120 mm

1,2 mm 1,2 mm
0,8 mm 0,8 mm

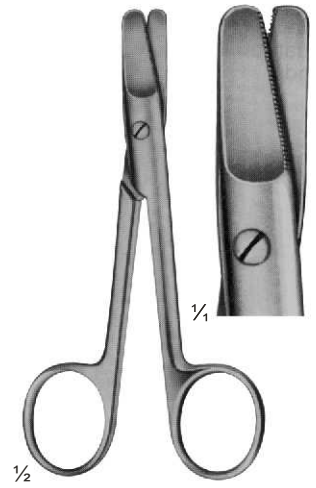

23-189
HARVEY
125 mm

0,4 mm
0,3 mm

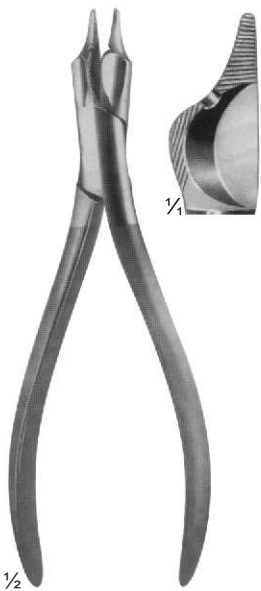

23-190
150 mm

for soft wire
up to diam
for hard wire
up to diam

1,5 mm
1,0 mm



23-191
160 mm

1,5 mm
1,2 mm



23-192
140 mm

1,5 mm
1,0 mm

Wire Cutting Pliers, Lateral Cutting Action

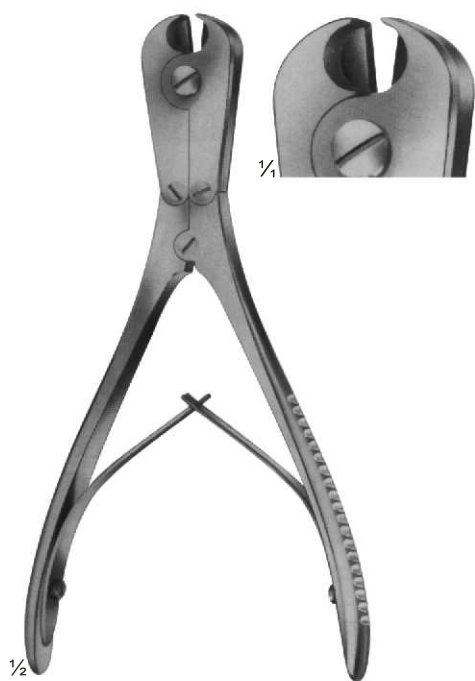

23-193
180 mm

for soft wire
up to diam. 2,0 mm
For hard wire 1,5 mm
up to diam
specially hardened
cutting edges, front
and lateral cutting
action



23-194
REILL
175 mm

for soft wire
up to diam. 2,0 mm
For hard wire 1,6 mm
up to diam
specially hardened
cutting edges, for
cutting off wires close
to the bone



23-195
235 mm

for soft wire
up to diam. 3,0 mm
For hard wire 2,2 mm
up to diam

Wire Cutting Pliers, Lateral and Front Cutting Action

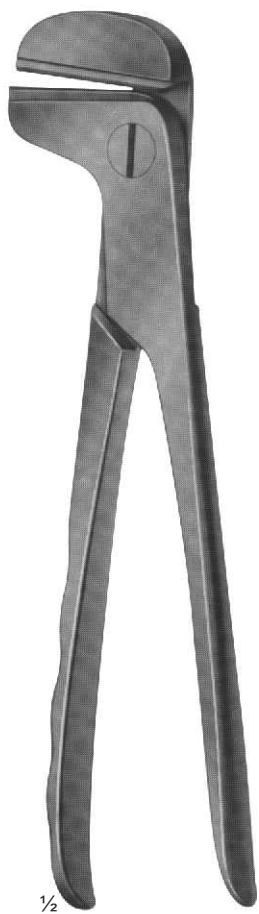

23-196
240 mm

for soft wire
up to diam.
For hard wire
up to diam

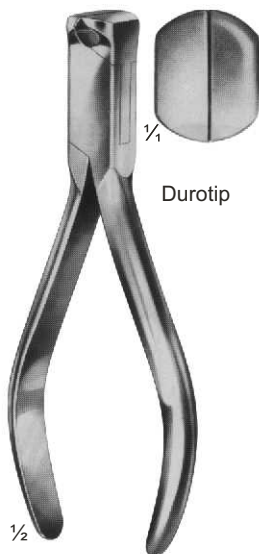

23-197
140 mm

for soft wire
up to diam.
For hard wire
up to diam

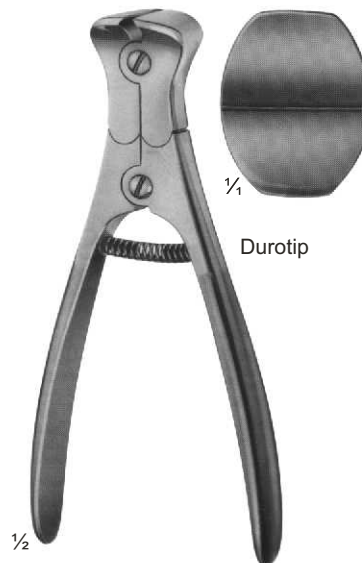

23-198
145 mm

for soft wire
up to diam.
For hard wire
up to diam

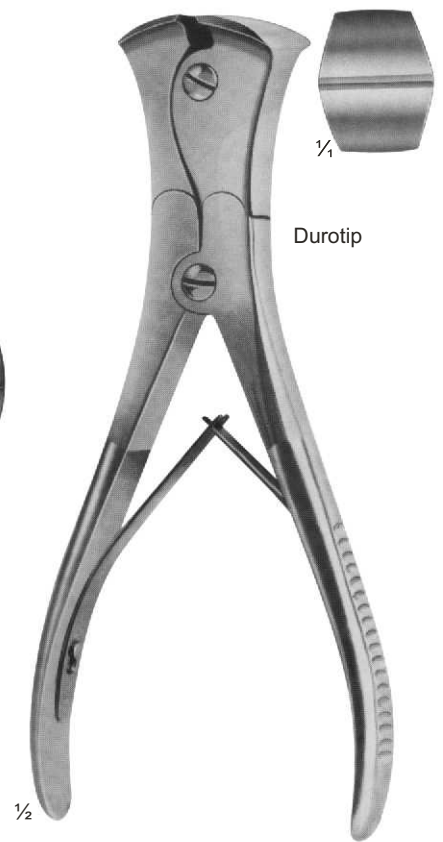

23-199
220 mm

for soft wire
up to diam.
For hard wire
up to diam

Wire Cutting Pliers



Cutter for cutting off
KIRSCHNER wires,
Tibia head screws,
bolts, pins, up to 3 mm diam.

23-200
320 mm

for soft wire up to diam. 3,0 mm
For hard wire up to diam 3,0 mm



Durotip

23-201
Cutter for cutting off
KIRSCHNER wires,
Tibia head screws,
bolts, pins, up to 6 mm diam.
470 mm

Finger Nail Instruments

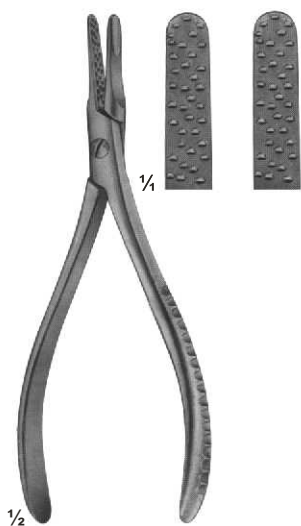

23-202
Nail extracting
forceps
135 mm



23-203
Nail extracting
forceps
145 mm

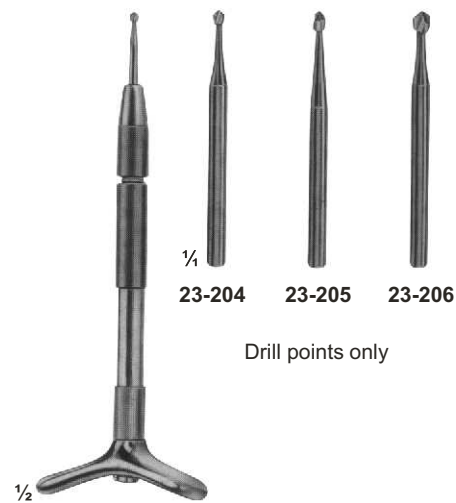

23-204 - 206
Finger nail drill
with 3 points

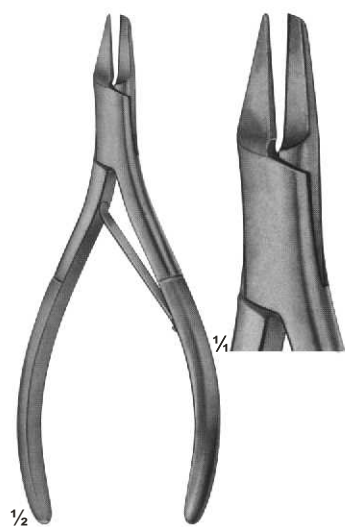

23-207
Nail splitting
forceps
135 mm

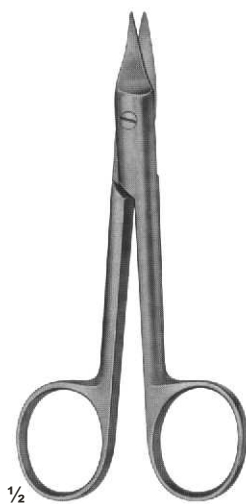

23-208
SYSTRUNK
Scissors, for splitting
finger nails
130 mm



23-209
Finger ring saw
150 mm

Plaster Instruments



with ebony handle

24-101
HOPKINS
200 mm



24-102
ESMARCH
180 mm



24-103
ENGEL
160 mm

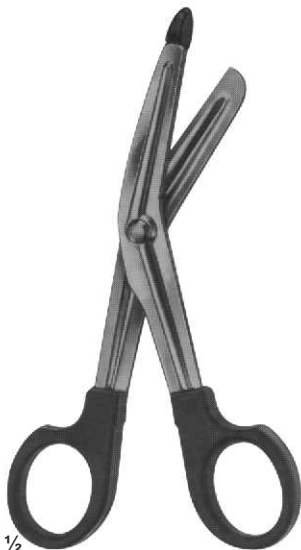

1/2

24-104 - 112

- | | | | |
|--------|-------|--------|-------------|
| 24-104 | black | 24-108 | yellow |
| 24-105 | red | 24-109 | white |
| 24-106 | blue | 24-110 | orange |
| 24-107 | green | 24-111 | lavender |
| | | 24-112 | bright pink |



1/2

24-113 - 121

- | | | | |
|--------|-------|--------|-------------|
| 24-113 | black | 24-117 | yellow |
| 24-114 | red | 24-118 | white |
| 24-115 | blue | 24-119 | orange |
| 24-116 | green | 24-120 | lavender |
| | | 24-121 | bright pink |

Plaster Scissors

For small plaster dressings

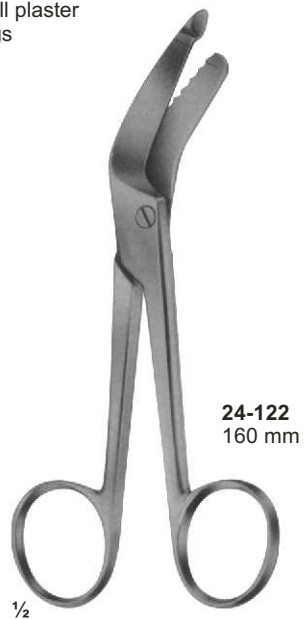

Plaster Shears



24-129
STILLE-AESULAP
260 mm



24-130
STILLE-AESULAP
360 mm

STILLE Plaster Shears

Blade with reinforced back



1/3

24-131
STILLE
230 mm

24-132
Spare blade



1/3

24-133
STILLE
370 mm

24-134
Spare blade



1/3

24-135
STILLE
240 mm

24-136
Spare blade

Plaster Spreader, Plaster Breakers



24-137
HENING
270 mm



24-138
MOD.USA
230 mm



24-139
290 mm



with removable jaws



24-140 - 141
WOLFF
24-140 180 mm
24-141 240 mm

Vacuum Currettes for Aspiration Lipectomy, Suction Instruments

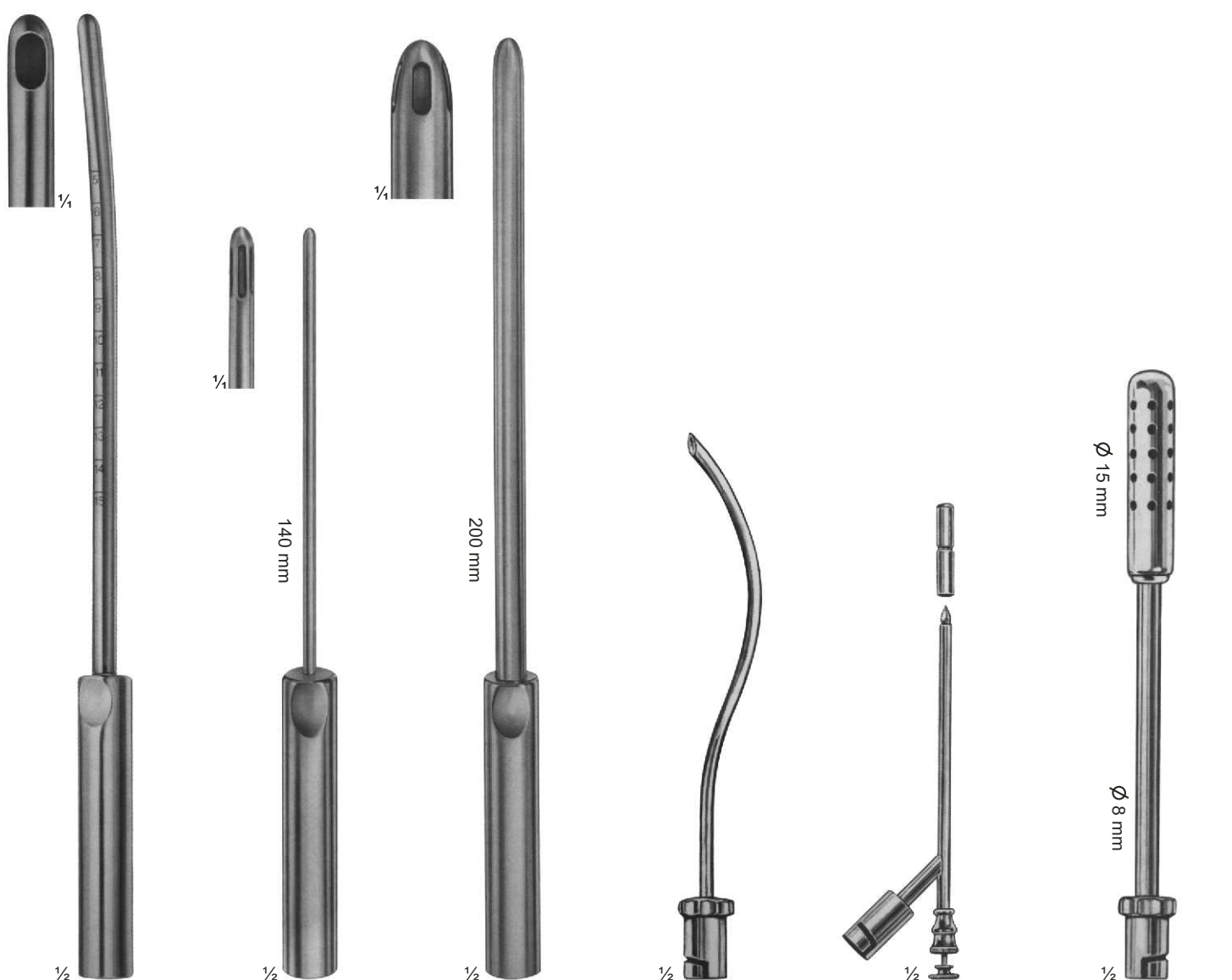

25-101 - 106
BIEMER

25-101 ø 4 mm
 25-102 ø 6 mm
 25-103 ø 8 mm
 25-104 ø 10 mm
 25-105 ø 12 mm
 25-106 ø 14 mm
 Curettes for aspiration lipectomy, graduated, slightly curved

25-107 - 108
BIEMER

25-107 ø 4 mm
 25-108 ø 6 mm
 Curettes for aspiration lipectomy, with three apertures, slightly curved malleable

25-109 - 111
BIEMER

25-109 ø 8 mm
 25-110 ø 10 mm
 25-111 ø 12 mm
 Curettes for aspiration lipectomy, with three apertures, slightly curved malleable

25-112
 For aspirating fluid from the excretory ducts of large glands and for keeping the operating area clear 170 mm

25-113
 Trocar
 For puncturing 150 mm

25-114
 For clearing large quantities of fluid 190 mm

Suction Instruments

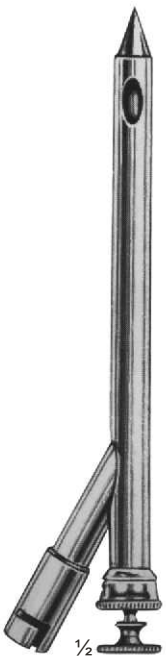

25-115
Trocar
For puncturing
170 mm



25-116
Hollow needle,
sharp
150 mm



25-117
double curved
For general
surgery
230 mm



25-118
For tonsillectomy,
oral and laryngeal
operations
190 mm

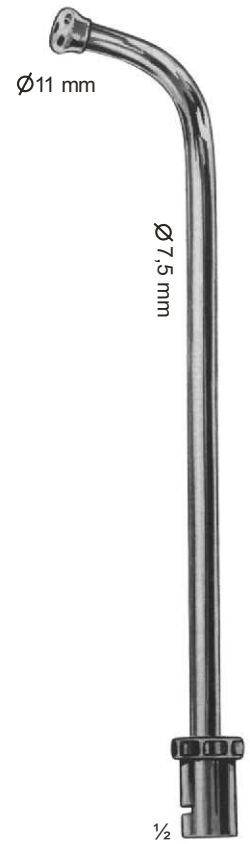

25-119
For tonsillectomy,
oral and laryngeal
operations
220 mm

Suction Instruments

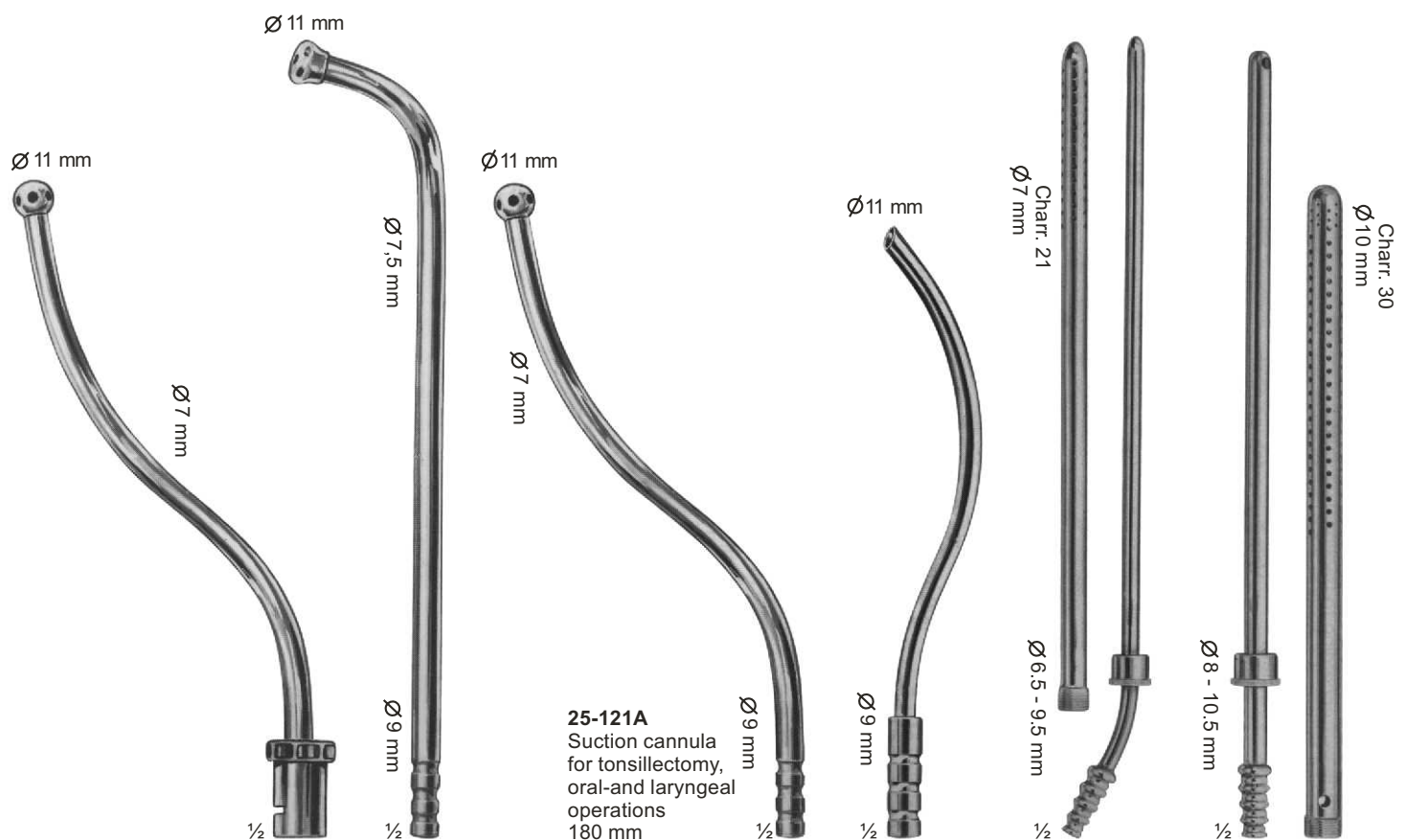

25-120
For tonsillectomy,
oral-and laryngeal
operations
180 mm

25-121
Suction cannula
for tonsillectomy,
oral-and laryngeal
operations
220 mm

25-121A
Suction cannula
for tonsillectomy,
oral-and laryngeal
operations
180 mm

25-122
S-shaped blunt cannula
for aspirating fluid from
the excretory ducts of
large glands and for
keeping the operations
area clear
170 mm

25-123
POOL
Suction cannula,
with outer tube
to be screwed of
225 mm

25-124
POOL
Suction cannula,
with outer tube
to be screwed of
225 mm

Suction Instruments

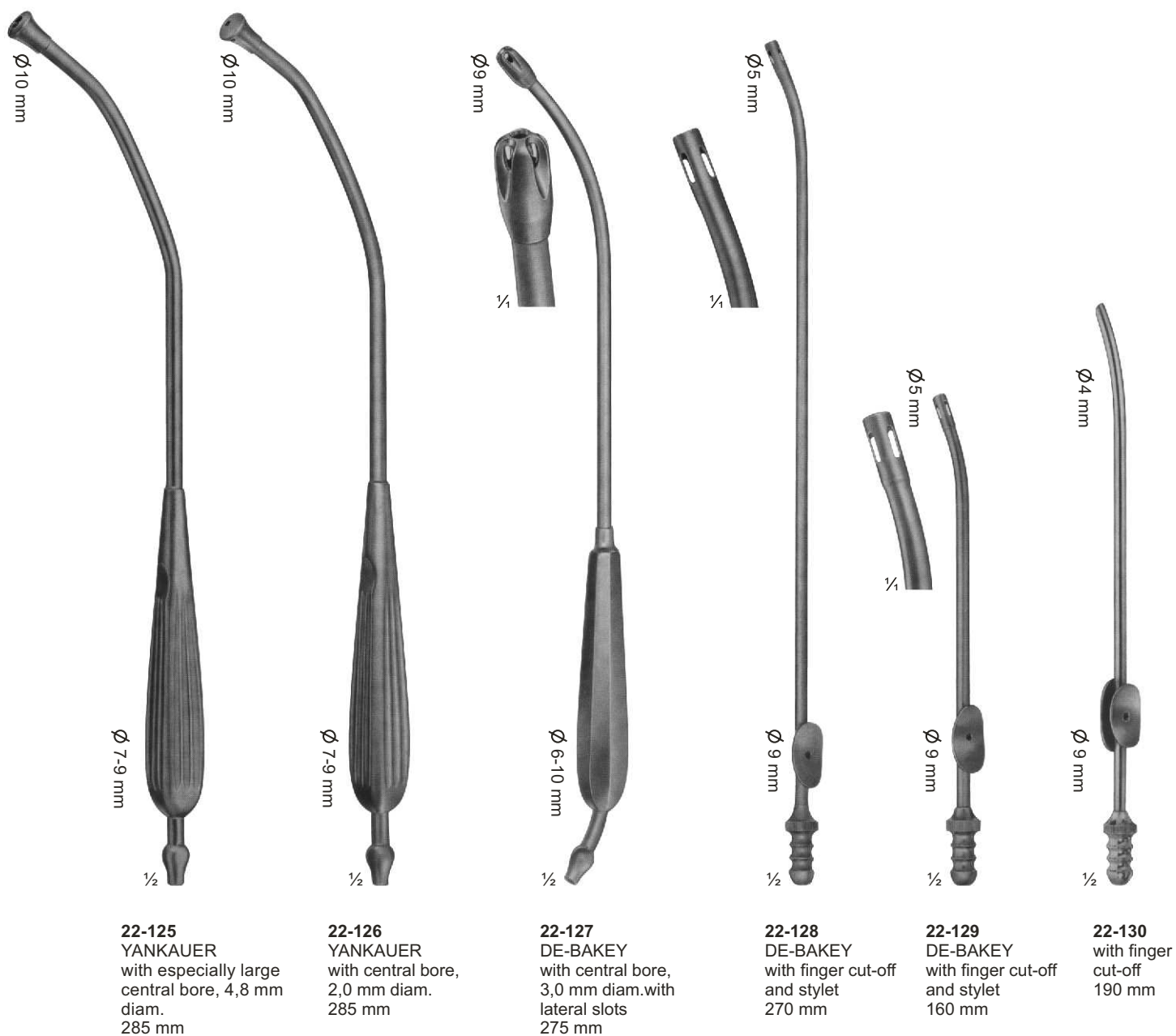

Suction Instruments



25-131 ∅ 1,5 mm
25-132 ∅ 2,0 mm
25-133 ∅ 2,5 mm
25-134 ∅ 3,0 mm

25-131 - 134
PLESTER
with finger cut-off and
stylet, thumb piece
parallel to curved, with
LUER hub
195 mm



25-135 ∅ 2,0 mm
25-136 ∅ 2,5 mm
25-137 ∅ 3,0 mm
25-138 ∅ 4,0 mm
25-139 ∅ 5,0 mm

25-135 - 139
FERGUSSON
with finger cut-off and
stylet, thumb piece
90° to curved, with
LUER hub
180 mm



25-140 ∅4,0 mm
FERGUSSON
insulated, with finger cut-off
and stylet, thumb piece 90°
to curved, with LUER hub
180 mm



25-141 ∅3,0 mm
25-142 ∅5,0 mm
FRAZIER
insulated, with finger
cut-off and stylet, thumb
piece 90° to curved,
with LUER hub
180 mm

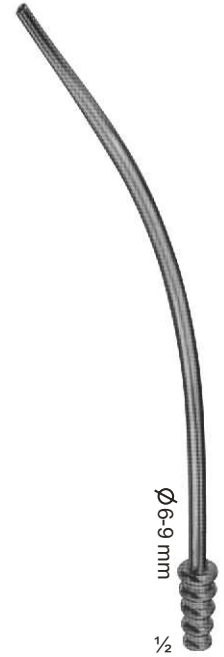

25-143
5,0 mm diam., Tip
6,5 mm wide, Nasal
suction tube, with
LUER hub
180 mm



25-144 ∅4,5 mm
25-145 ∅5,5 mm
Nasal suction
tubes
175 mm



25-146
GORNEY
Suction dissector
180 mm



25-147 4 mm wide
25-148 5 mm wide
Suction raspatories,
sharp, bayonet-shaped,
with stylet
200 mm



25-149
LOPEZ-REINKE
Tonsil dissector with
suction device
235 mm

Suction Instruments

25-150
WULLSTEIN
Suction tube, conical, silver, oliver
with LUER hub
160 mm

$\varnothing 1,75$ mm

$\varnothing 3$ mm
 $\frac{1}{2}$
 $\varnothing 8$ mm

25-151 1,5 mm
25-152 2,0 mm
WULLSTEIN
Suction tube, cylindrical, silver, with
stylet with LUER hub
160 mm

$\frac{1}{2}$
 $\varnothing 8$ mm

Usable length

YASARGIL usable length diam.			YASARGIL usable length diam.		
25-153	130 mm	1,5 mm	25-161	130 mm	2,5 mm
25-154	150 mm	1,5 mm	25-162	150 mm	2,5 mm
25-155	180 mm	1,5 mm	25-163	180 mm	2,5 mm
25-156	220 mm	1,5 mm	25-164	220 mm	2,5 mm
25-157	130 mm	2,0 mm	25-165	130 mm	3,5 mm
25-158	150 mm	2,0 mm	25-166	150 mm	3,5 mm
25-159	180 mm	2,0 mm	25-167	180 mm	3,5 mm
25-160	220 mm	2,0 mm	25-168	220 mm	3,5 mm
			25-169	180 mm	4,5 mm

$\varnothing 6,5-9$ mm
with LUER hub

25-170 - 172
LANDOLT
150 MM
diam $\varnothing 3$ mm

25-170 8 mm / curved
25-171 11mm / curved
25-172 15mm / curved

$\frac{1}{2}$
 $\frac{1}{2}$

$\varnothing 3.5$ mm

$\varnothing 2.0$ mm

25-173 500 mm
25-174 350 mm
with rubber tip,
with LUER hub

$\varnothing 9$ mm
 $\frac{1}{2}$

25-175 2,0 mm diam
25-176 2,5 mm diam
25-177 3,0 mm diam
with finger cut-off,
thumb piece 90° to
curved, with LUER hub
250 mm

$\varnothing 6-9$ mm
 $\frac{1}{2}$

Combined Suction and Irrigation Cannulae

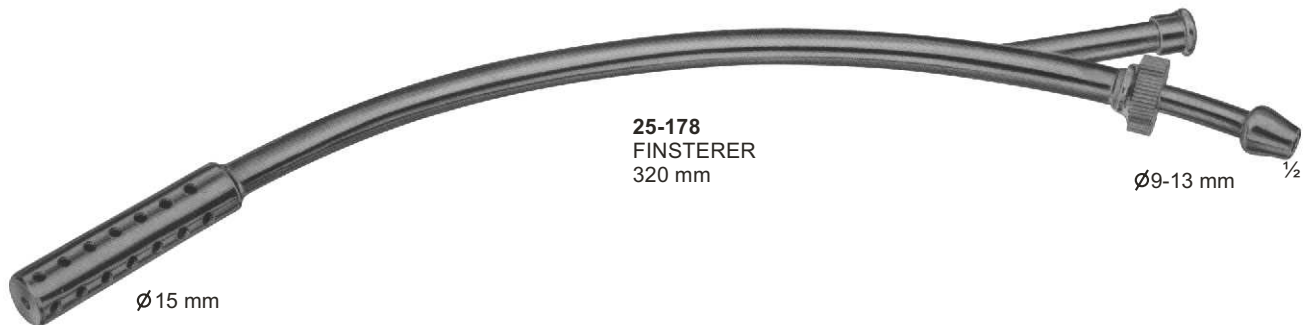

25-178
FINSTERER
320 mm

Ø9-13 mm 1/2

Ø 15 mm



Ø 2 mm

Ø 4,5 mm

25-179
YASARGIL
LURE-LOCK cone
200 mm

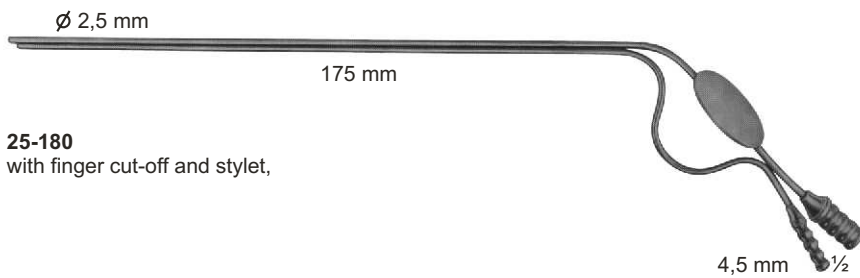

Ø 2,5 mm

175 mm

25-180
with finger cut-off and stylet,

4,5 mm 1/2

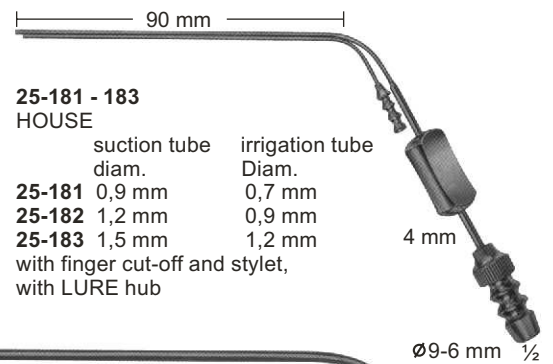

90 mm

25-181 - 183
HOUSE

	suction tube diam.	irrigation tube Diam.
25-181	0,9 mm	0,7 mm
25-182	1,2 mm	0,9 mm
25-183	1,5 mm	1,2 mm

with finger cut-off and stylet, with LURE hub

4 mm



25-184 3,5 mm
with LURE-LOCK cone

250 mm

Ø9-6 mm 1/2



25-185
LANDOLT
with finger cut-off and stylet, can be sterilized in an autoclave up to 3 bar (143 °C)

Ø9 mm 1/2

Connection for suction hose

Ø 7,5-12 mm

4 mm diam., Untraniished contact to be touched by HF-eleatodes

1/2

Scissors with Tungsten Carbide Inserts



26-101
Standard

14,5cm
16,5cm
18,5cm



26-102
Standard

14,5cm
16,5cm
18,5cm



26-103
Standard

14,5cm
16,5cm
18,5cm



26-104
Standard

14,5cm
16,5cm
18,5cm



26-105
Standard

14,5cm
16,5cm
18,5cm



26-106
Standard

14,5cm
16,5cm
18,5cm

Scissors with Tungsten Carbide Inserts



26-107
Mayo-Lexer



26-108
Mayo-Lexer



26-109
Lexer

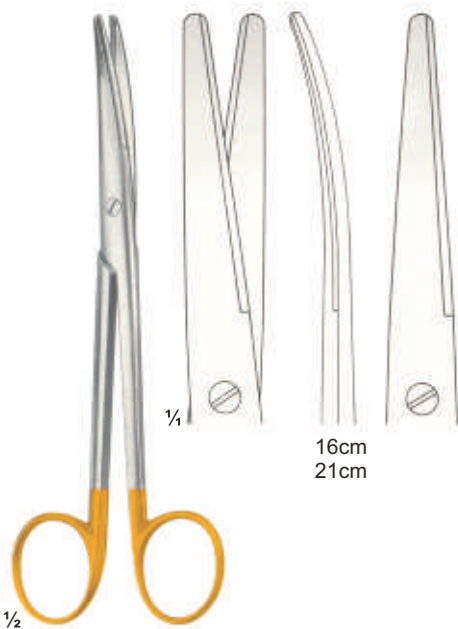

26-110
Lexer



26-111
Mayo-Stille



26-112
Mayo-Stille

Scissors with Tungsten Carbide Inserts



Scissors with Tungsten Carbide Inserts

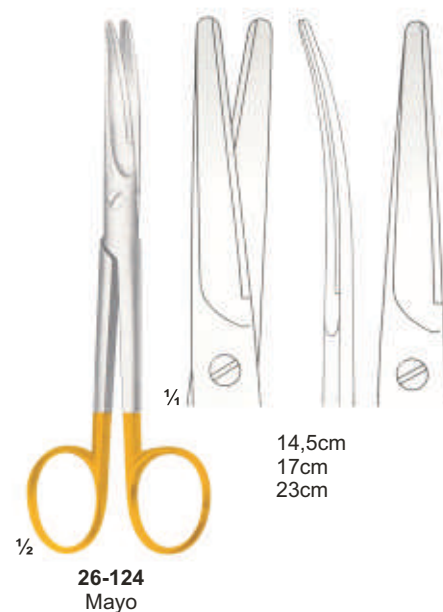

Scissors with Tungsten Carbide Inserts



Scissors with Tungsten Carbide Inserts

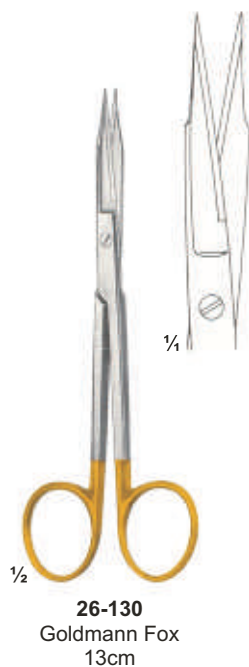

Scissors & Dissecting Forceps with Tungsten Carbide Inserts

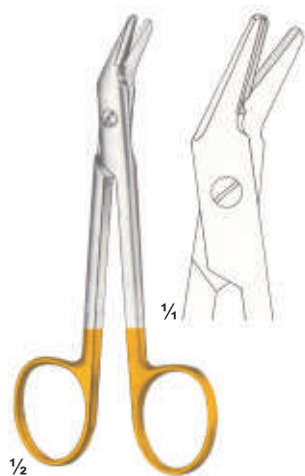

26-136
Universal
12cm



26-137
Ligature Scissors
1 Black & 1 Goldplated ring

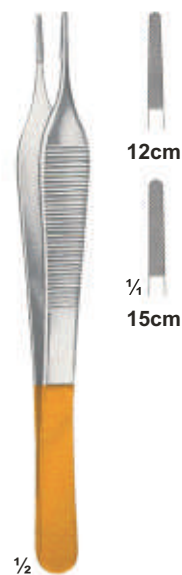

26-138
Adson



26-139
Cushing
17,5cm



26-140
Cushing
18cm



26-141
Cushing-Taylor
18cm



26-142
Dissecting Forceps
15cm



26-143
Semken
15cm

Dissecting Forceps and Needle holders with Tungsten Carbide Inserts



26-144
Wangenstein

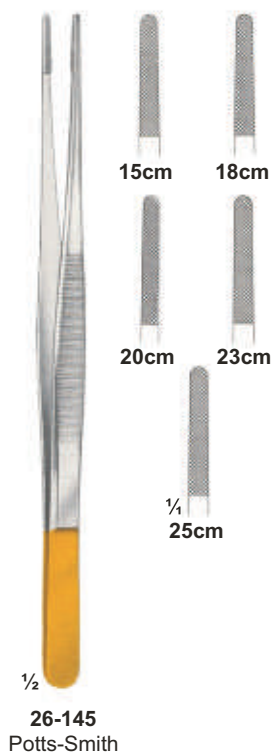

26-145
Potts-Smith

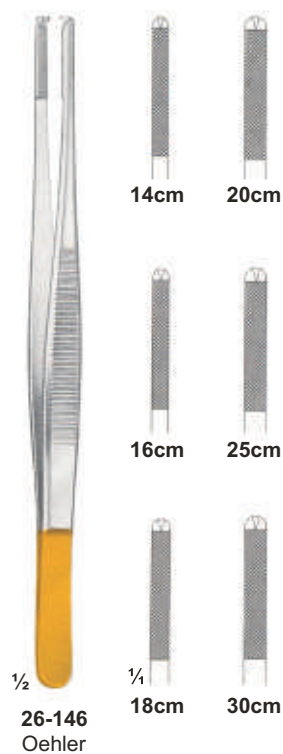

26-146
Oehler



26-147
Potts-Smith
22cm



26-148
Hepp-Scheidle
18cm



26-149
Castroviejo
14cm



26-150
Castroviejo
14cm



26-151
Arruga
16cm

Needle holders with Tungsten Carbide Inserts



26-152
Arruga
16cm



26-153
Castroviejo
13cm



26-154
Hegar
20cm 24cm

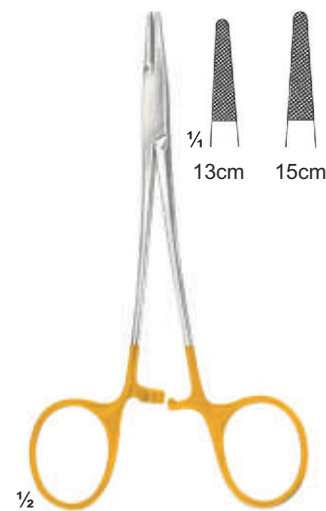

26-155
Halsey
13cm 15cm



26-156
Mayo-Hegar
16cm 18cm 20cm
24cm 26cm 30cm

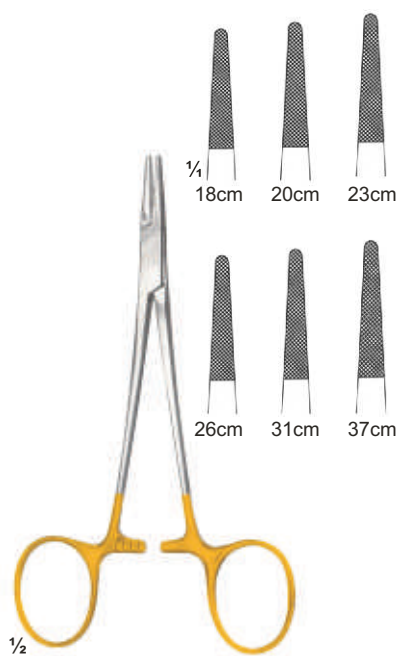

26-157
De-Bakey
18cm 20cm 23cm
26cm 31cm 37cm

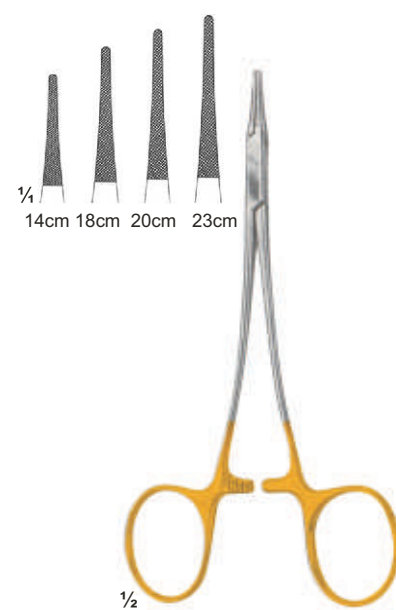

26-158
Hegar-Vascular
14cm 18cm
20cm 23cm

Needle holders with Tungsten Carbide Inserts



26-159
Bozemann-Wertheim
20cm 24cm 26cm

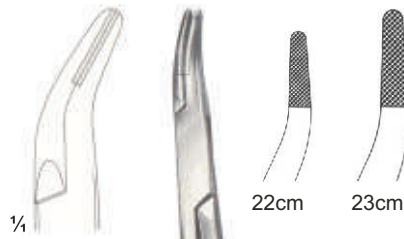

26-160
Stratte
22cm 23cm

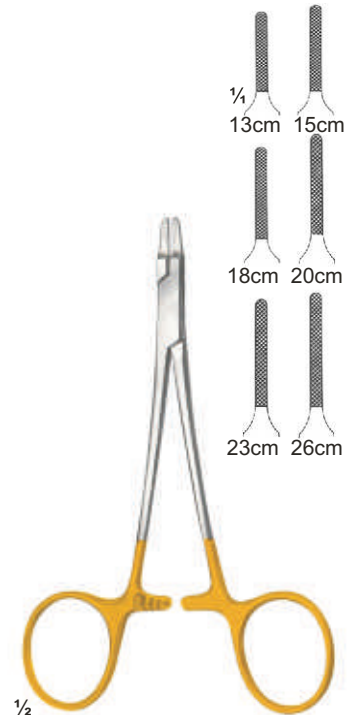

26-161
Ryder
13cm 15cm 18cm
20cm 23cm 26cm

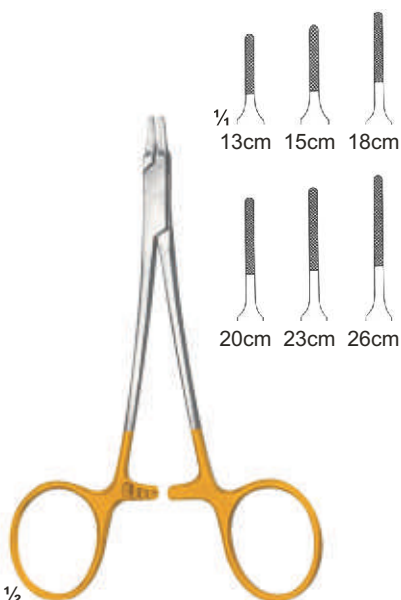

26-162
Ryder-Vascular
13cm 15cm 18cm
20cm 23cm 26cm



26-163
Martin
15cm 17cm 20cm



26-164
Sarot
18cm 20cm 26cm

Needle holders with Tungsten Carbide Inserts



Needle holders with Tungsten Carbide Inserts

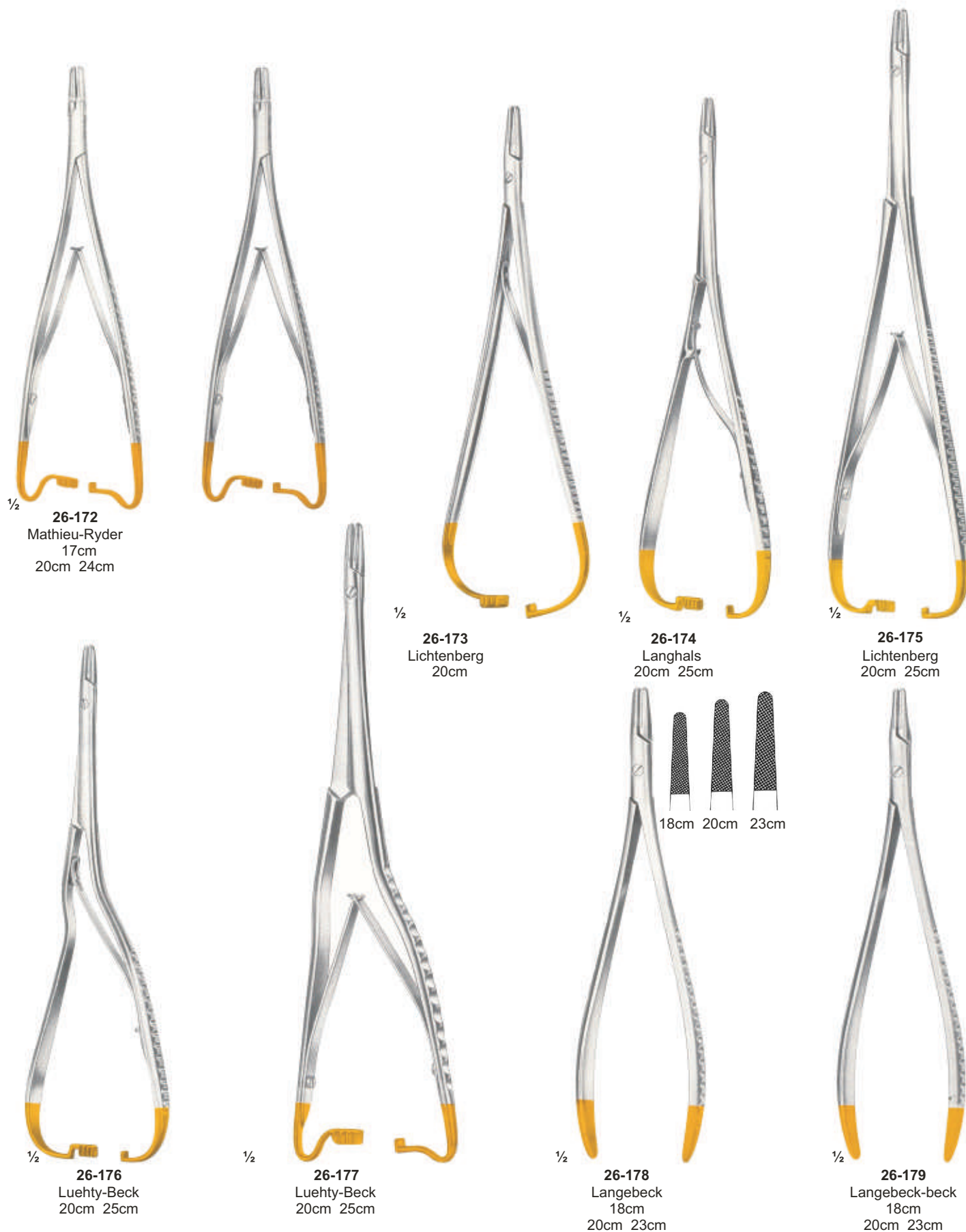

1/2
26-172
 Mathieu-Ryder
 17cm
 20cm 24cm

1/2
26-173
 Lichtenberg
 20cm

1/2
26-174
 Langhals
 20cm 25cm

1/2
26-175
 Lichtenberg
 20cm 25cm

18cm 20cm 23cm

1/2
26-176
 Luehty-Beck
 20cm 25cm

1/2
26-177
 Luehty-Beck
 20cm 25cm

1/2
26-178
 Langebeck
 18cm
 20cm 23cm

1/2
26-179
 Langebeck-beck
 18cm
 20cm 23cm

Hospital Wares



27-101 - 115
Schimmelbusch

	Ø x H sizes in mm
27-101	80 x 80
27-102	105 x 120
27-103	140 x 140
27-104	160 x 120
27-105	160 x 150
27-106	190 x 150
27-107	190 x 190
27-108	240 x 160
27-109	240 x 240
27-110	290 x 160
27-111	290 x 240
27-112	340 x 160
27-113	340 x 340
27-114	390 x 190
27-115	390 x 290

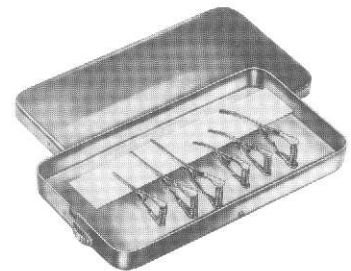

27-116
Box
120 x 65 x 13mm
(without Bulldog clamps,
without silicone tape)



27-117
Box with support
120 x 65 x 13 mm
(ohne Bulldogklemmen)



27-118
Box with support for
needle electrodes,
without instruments

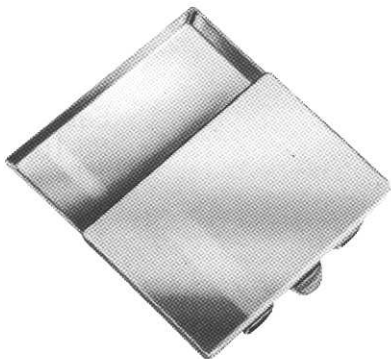

27-119 - 121
50 x 25 x 4,5 mm
27-120
65 x 42 x 8 mm
27-121
75 x 25 x 4,5 mm

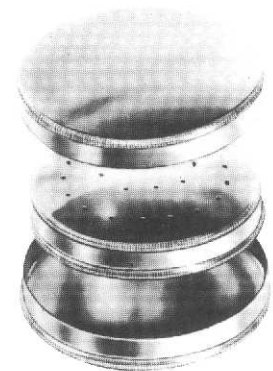

27-122
Ø 65mm x 15mm

Hospital Wares

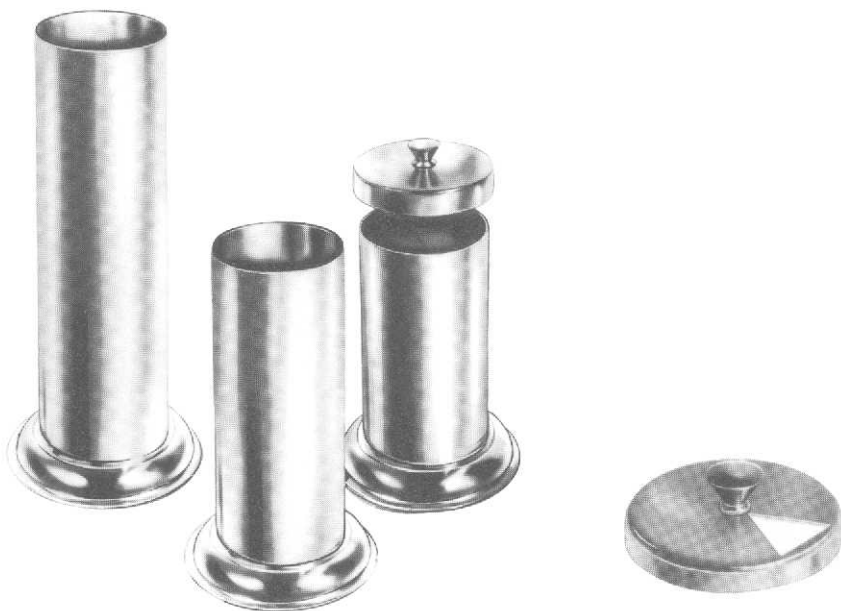

27-123 - 131

	Ø x H
27-123	30 x 90 mm
27-124	50 x 100 mm
27-125	50 x 130 mm
27-126	50 x 175 mm
27-127	75 x 100 mm
27-128	75 x 130 mm
27-129	75 x 175 mm
27-130	100 x 175 mm
27-131	100 x 200 mm



27-132 - 139

27-132	165 x 85 x 35 mm
27-133	200 x 100 x 35 mm
27-134	200 x 100 x 50 mm
27-135	230 x 130 x 50 mm
27-136	260 x 150 x 50 mm
27-137	270 x 235 x 50 mm
27-138	300 x 200 x 50 mm
27-139	325 x 275 x 50 mm



27-140
205 x 105 x 35 mm

Forceps Jars

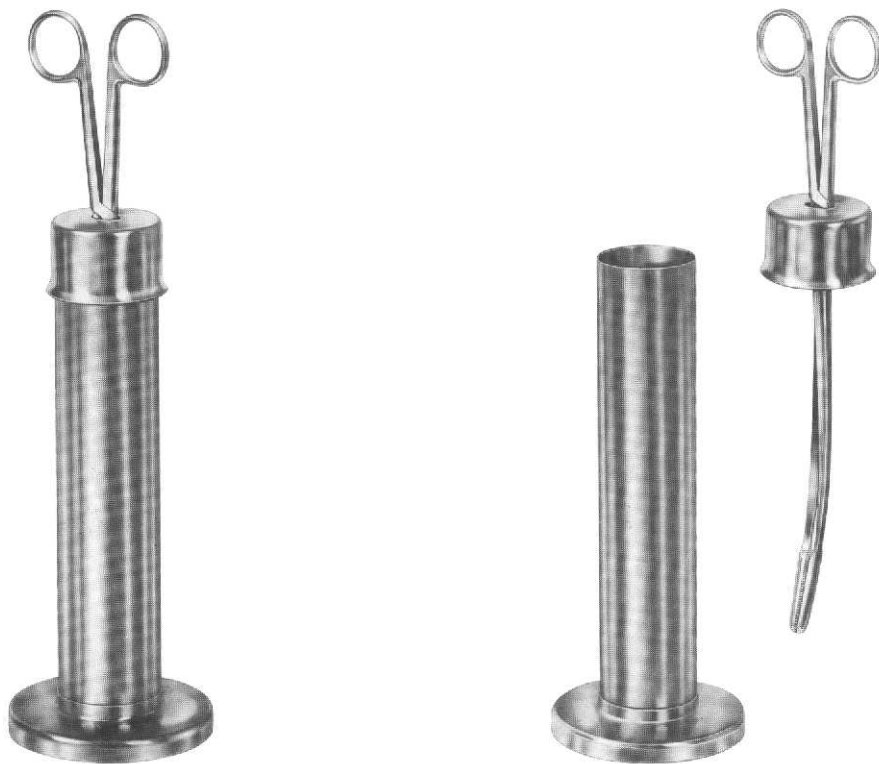

27-141 - 142

- 27-141** | Martin Sterilizing Forceps
consisting of:
1 Sterilizing Forceps, curved, 25 cm,
without ratchet, with lid for jar
1 jar with bottom plate (anti-tilt)
- 27-142** | ditto, with 32 cm long Sterilizing Forceps

Round Metal Boxes and Medicine Cups



27-143 - 148

	Ø x H
27-143	75 x 60 mm
27-144	75 x 75 mm
27-145	100 x 60 mm
27-146	100 x 100 mm
27-146A	125 x 80 mm
27-147	125 x 125 mm
27-148	150 x 150 mm

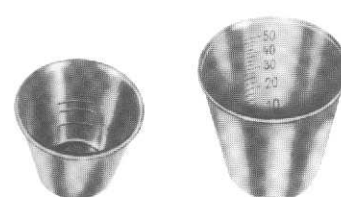

27-149
25 cc

27-150
50 cc



27-151
20 cc
Medicine Spoon

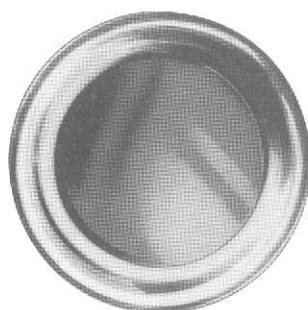

27-152
Ø75 x 12 mm
Tablet Tray



27-153
Ø90 x 90 mm
Metal Cup



27-154
Ø75 x 80 mm
Sputum Cup

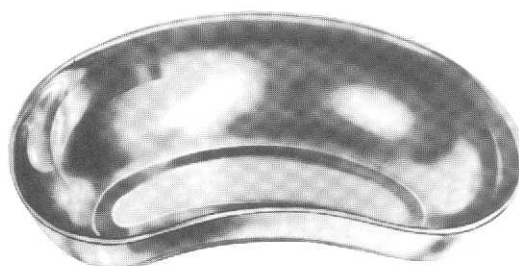

Kidney Dish

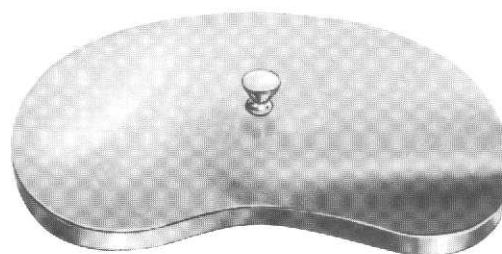

27-155 - 157

27-155	170 x 100 x 35 mm
27-156	250 x 140 x 40 mm
27-157	275 x 150 x 45 mm

Hospital Wares

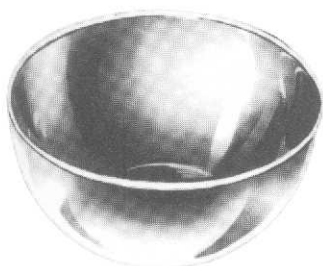

27-158 - 165

	Ø x H	
27-158	40 x 19 mm	0.05L
27-159	61 x 30 mm	0.07L
27-160	80 x 40 mm	0.14L
27-161	116 x 50 mm	0.35L
27-162	128 x 55 mm	0.45L
27-163	147 x 65 mm	0.70L
27-164	167 x 75 mm	1.10L
27-165	187 x 85 mm	1.60L

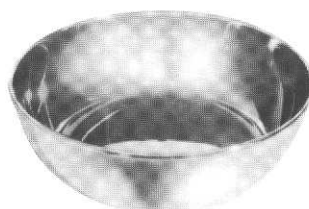

27-166 - 170

27-166	116 x 35 mm	0.30L
27-167	128 x 38 mm	0.40L
27-168	147 x 40 mm	0.50L
27-169	157 x 45 mm	0.75L
27-170	187 x 45 mm	1.00L



27-171
Ø 110 x 28 mm 0.15L



27-172
100 cc 0.1L



27-173 - 176
27-173 0,25L
27-174 0,50L
27-175 1,00L
27-176 2,00L



27-177
235 x 190 x 40 mm



27-178
Ø220 x 70 mm

Hospital Wares

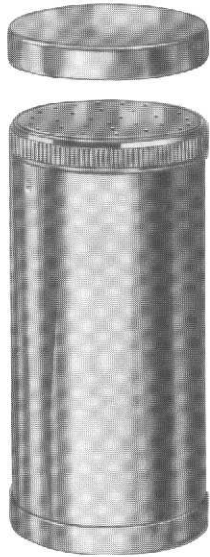

27-179
Ø 50 x 100 mm
Powder Pot

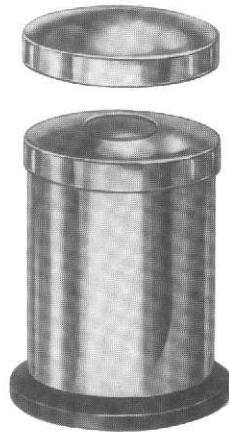

27-180
Ø 50 x 75 mm
Methot With Lid

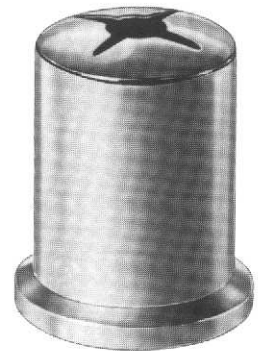

27-181
Ø 50 x 75 mm
Methot Without Lid

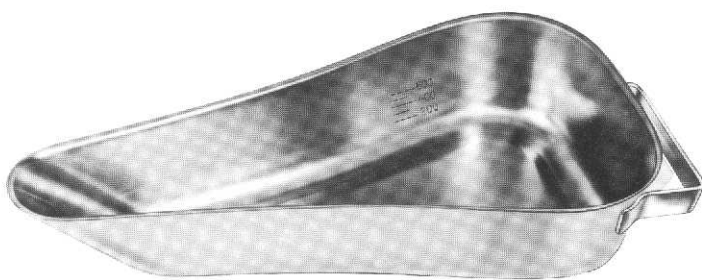

27-182

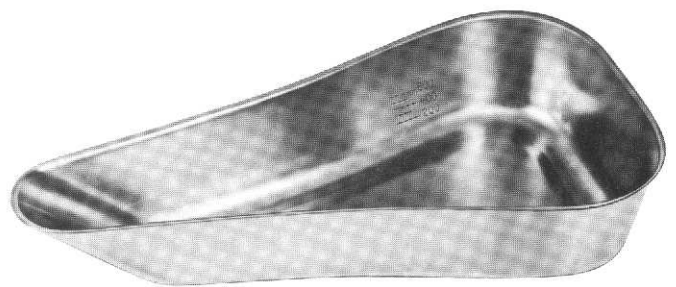

27-183



27-184

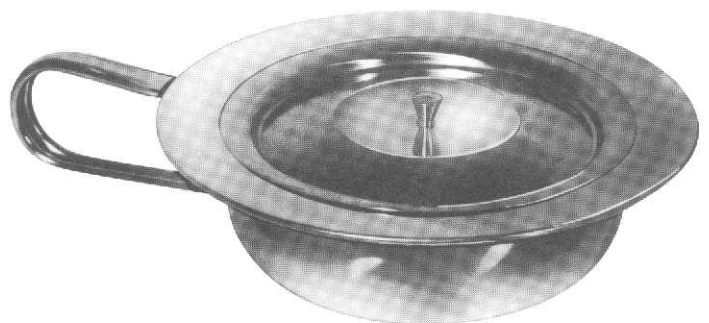

27-185 - 186

27-185 Ø 235 mm
27-186 Ø 310 mm

Needle Cases



27-187
Sauerbruch
210 x 125 x 17 mm



27-188
Sauerbruch
210 x 125 x 17 mm



27-189
150 x 95 x 13 mm

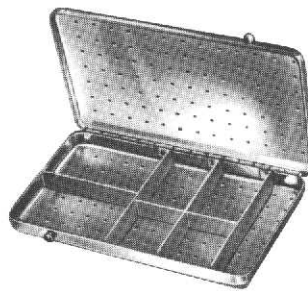

27-190
150 x 95 x 13 mm

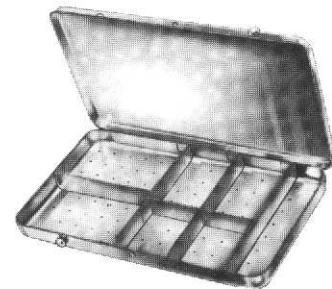

27-191
150 x 95 x 13 mm



27-192
150 x 95 x 13 mm



27-193
150 x 95 x 13 mm



27-194
150 x 95 x 13 mm

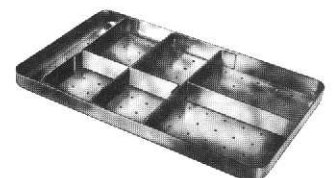

27-195
150 x 95 x 11 mm

Storing Cases



27-196
Deponette
245 x 135 x 35mm



27-197
Deponette
245 x 135 x 50mm

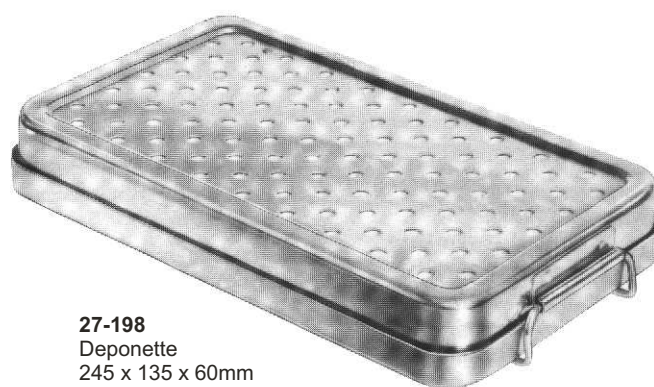

27-198
Deponette
245 x 135 x 60mm

Storing Cases

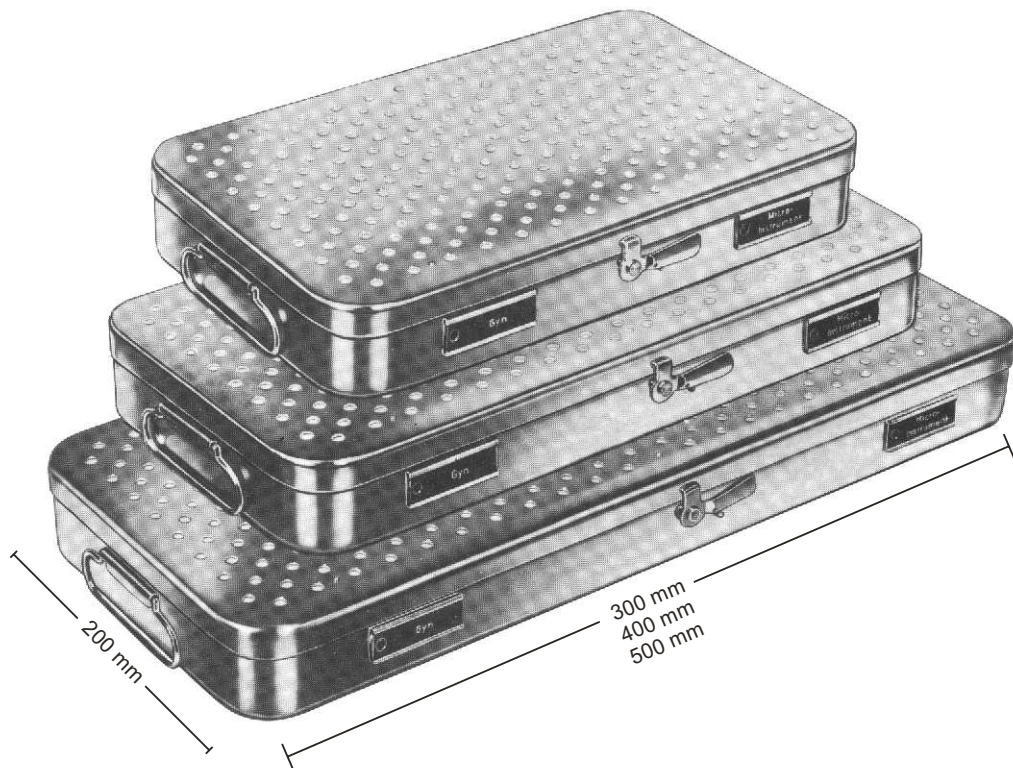

27-199 - 209

27-199	230 x 130 x 50	mm
27-200	260 x 150 x 50	mm
27-201	275 x 235 x 50	mm
27-202	300 x 200 x 50	mm
27-203	325 x 275 x 50	mm
27-204	420 x 175 x 50	mm
27-205	230 x 130 x 75	mm
27-206	260 x 150 x 75	mm
27-207	300 x 200 x 75	mm
27-208	325 x 275 x 75	mm
27-209	420 x 175 x 75	mm

Sterilizing Baskets / Trays

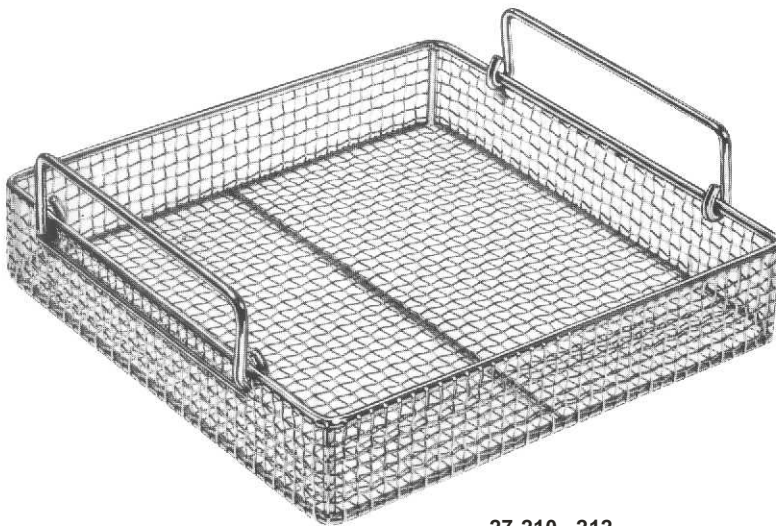

27-210 - 212

27-210	480 x 250 x 50	mm
27-211	520 x 250 x 75	mm
27-212	520 x 250 x 100	mm



27-213 - 218

27-213	240 x 240 x 50	mm
27-214	240 x 240 x 80	mm
27-215	240 x 240 x 100	mm
27-216	480 x 260 x 50	mm
27-217	520 x 260 x 80	mm
27-218	520 x 260 x 100	mm

CONTACT US



Nolly Moor Raras Road Near Elmed Surgical Sialkot 51310 Pakistan.



+92 300 6315002



info@rassurgical.com



www.rassurgical.com